



**ELECTROSTATIC SENSITIVE DEVICE**  
OBSERVE HANDLING PRECAUTIONS

**MITSUBISHI RF POWER MOS FET**

# RD12MVS1

**RoHS Compliance, Silicon MOSFET Power Transistor, 175MHz, 12W**

## DESCRIPTION

RD12MVS1 is a MOS FET type transistor specifically designed for VHF RF power amplifiers applications.

## FEATURES

High Power Gain:  
 $P_{out} > 11.5W$ ,  $G_p > 12dB @ V_{DD} = 7.2V, f = 175MHz$   
 High Efficiency: 57%typ. (175MHz)

## APPLICATION

For output stage of high power amplifiers in VHF band mobile radio sets.

## RoHS COMPLIANT

RD12MVS1-101, T112 is a RoHS compliant products.

RoHS compliance is indicate by the letter "G" after the Lot Marking.

This product include the lead in high melting temperature type solders.

How ever, it applicable to the following exceptions of RoHS Directions.

1. Lead in high melting temperature type solders (i.e. tin-lead older alloys containing more than 85% lead.)

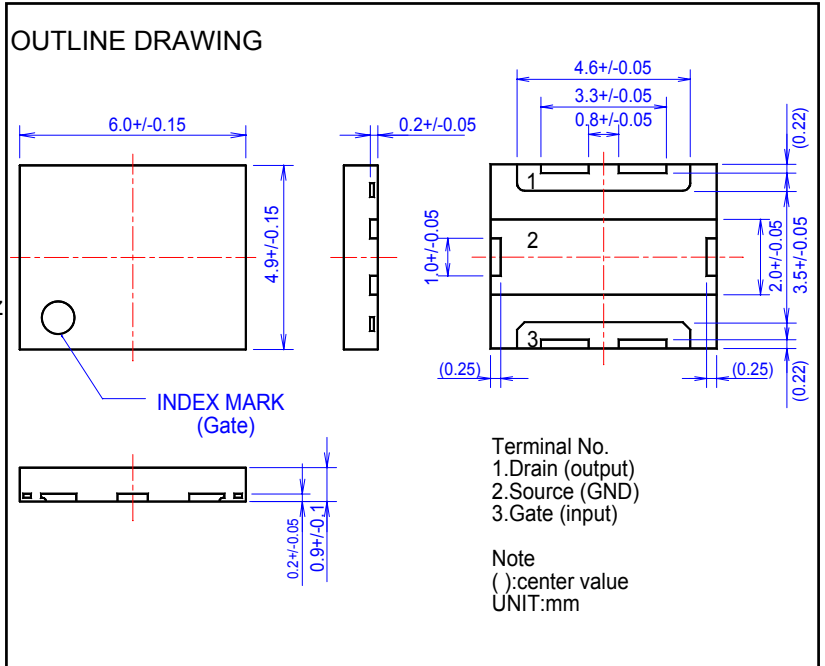

## ABSOLUTE MAXIMUM RATINGS

( $T_c = 25^\circ C$ , UNLESS OTHERWISE NOTED)

SYMBOL	PARAMETER	CONDITIONS	RATINGS	UNIT
$V_{DSS}$	Drain to Source Voltage	$V_{GS} = 0V$	50	V
$V_{GSS}$	Gate to Source Voltage	$V_{DS} = 0V$	+/- 20	V
$I_D$	Drain Current		4	A
$P_{in}$	Input Power	$Z_g = Z_l = 50\Omega$	2	W
$P_{ch}$	Channel Dissipation	$T_c = 25^\circ C$	50	W
$T_j$	Junction Temperature		150	$^\circ C$
$T_{stg}$	Storage Temperature		-40 to +125	$^\circ C$
$R_{thj-c}$	Thermal Resistance	Junction to Case	2.5	$^\circ C/W$

Note: Above parameters are guaranteed independently.

## ELECTRICAL CHARACTERISTICS ( $T_c = 25^\circ C$ , UNLESS OTHERWISE NOTED)

SYMBOL	PARAMETER	CONDITIONS	LIMITS			UNIT
			MIN.	TYP.	MAX.	
$I_{DSS}$	Zero Gate Voltage Drain Current	$V_{DS} = 17V, V_{GS} = 0V$	-	-	10	$\mu A$
$I_{GSS}$	Gate to Source Leak Current	$V_{GS} = 10V, V_{DS} = 0V$	-	-	1	$\mu A$
$V_{TH}$	Gate Threshold Voltage	$V_{DS} = 12V, I_{DS} = 1mA$	1.8	-	4.4	V
$P_{out}$	Output Power	$f = 175MHz, V_{DD} = 7.2V$	11.5	12	-	W
$\eta_D$	Drain Efficiency	$P_{in} = 1.0W, I_{dq} = 1.0A$	55	57	-	%
	Load VSWR tolerance	$V_{DD} = 9.2V, P_o = 12W$ (Pin Control) $f = 175MHz, I_{dq} = 1.0A, Z_g = 50\Omega$ Load VSWR = 20:1 (All Phase)	Not destroy			-

Note: Above parameters, ratings, limits and conditions are subject to change.



ELECTROSTATIC SENSITIVE DEVICE  
OBSERVE HANDLING PRECAUTIONS

MITSUBISHI RF POWER MOS FET

# RD12MVS1

RoHS Compliance, Silicon MOSFET Power Transistor, 175MHz, 12W

## TYPICAL CHARACTERISTICS

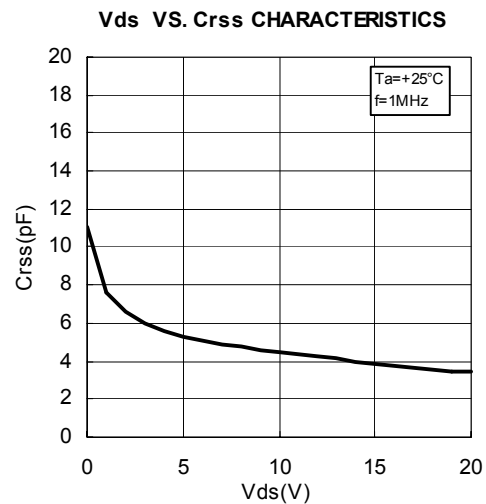
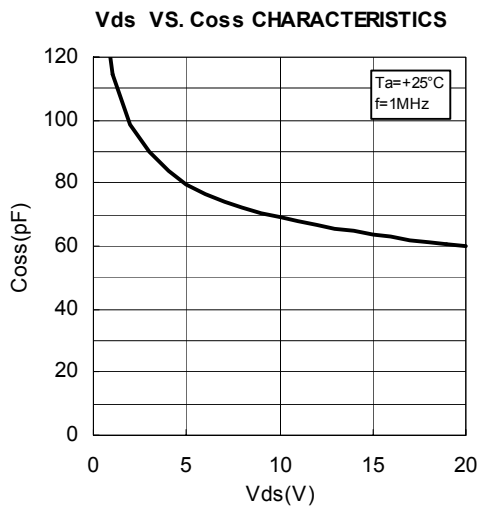
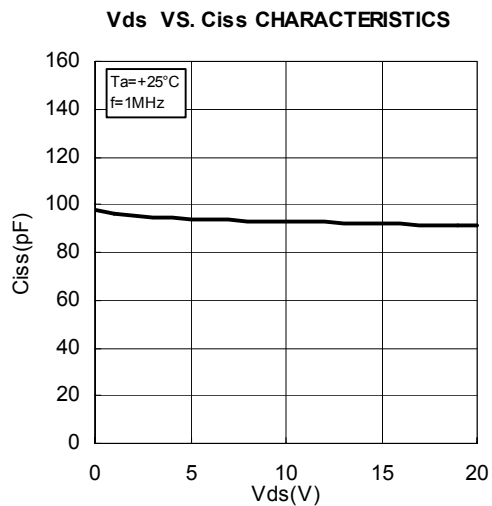
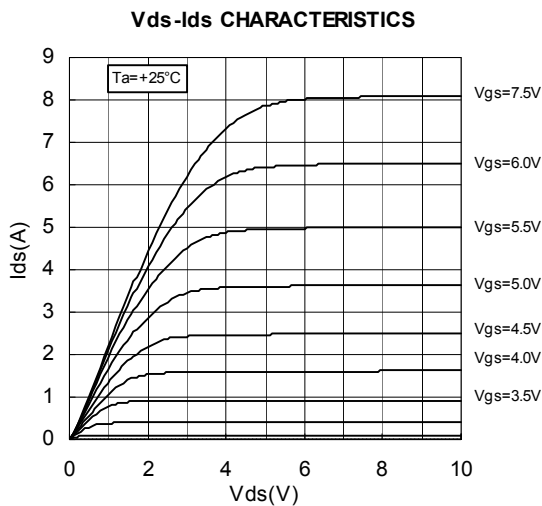
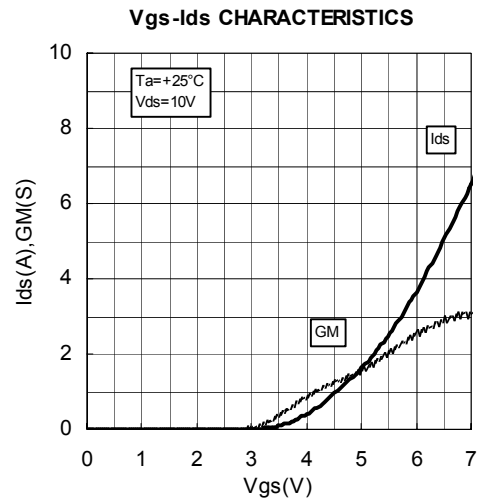
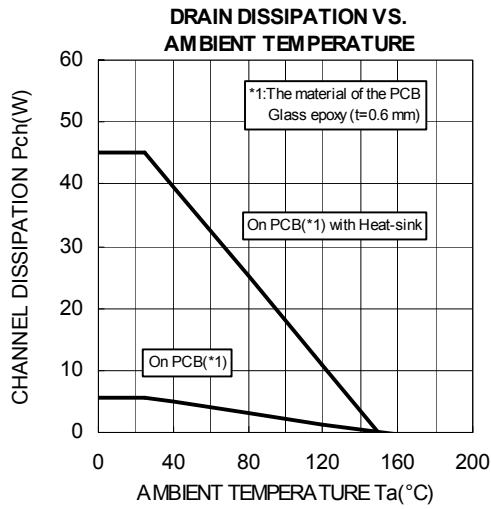

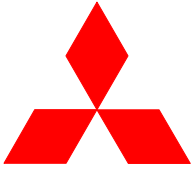

ELECTROSTATIC SENSITIVE DEVICE  
OBSERVE HANDLING PRECAUTIONS

MITSUBISHI RF POWER MOS FET

# RD12MVS1

RoHS Compliance, Silicon MOSFET Power Transistor, 175MHz, 12W

## TYPICAL CHARACTERISTICS

Pin-Po CHARACTERISTICS @f=175MHz

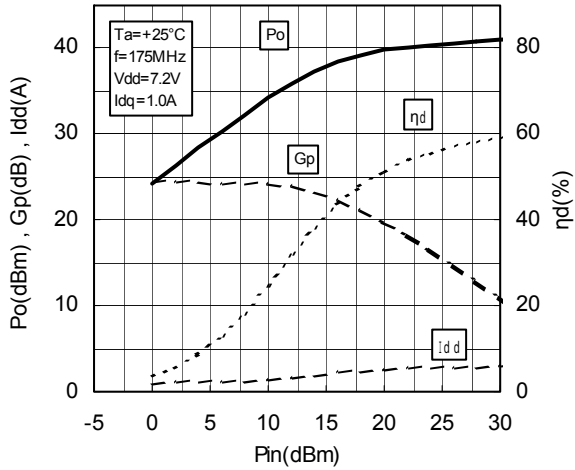

Pin-Po CHARACTERISTICS @f=175MHz

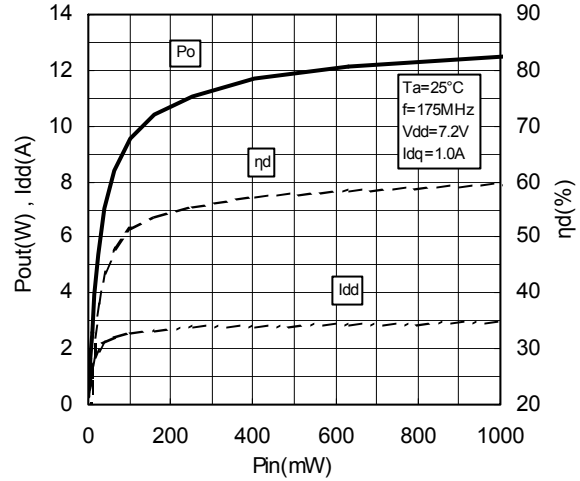

Vdd-Po CHARACTERISTICS @f=175MHz

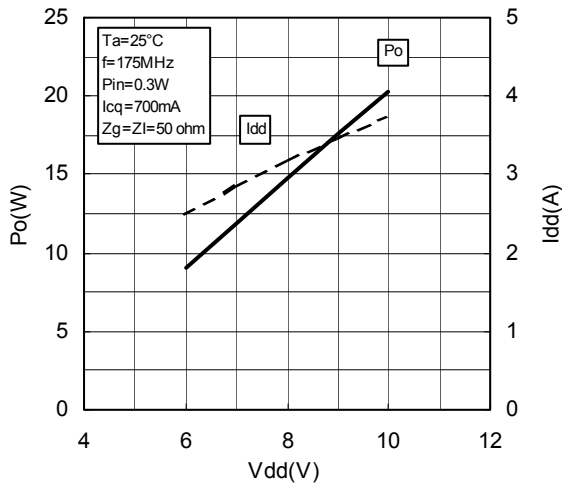

Vgs-Ids CHARACTERISTICS 2

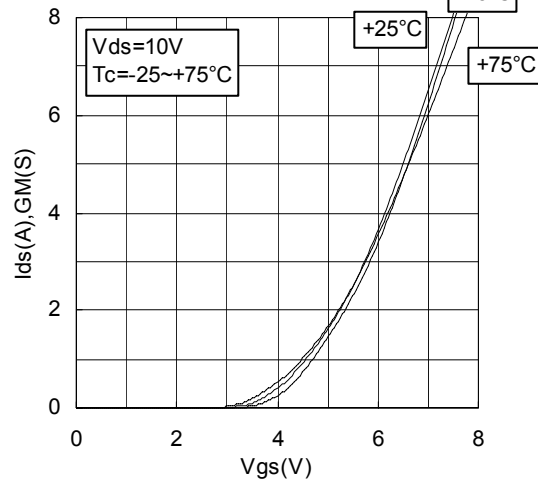

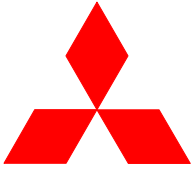

**ELECTROSTATIC SENSITIVE DEVICE**  
OBSERVE HANDLING PRECAUTIONS

MITSUBISHI RF POWER MOS FET

**RD12MVS1**

RoHS Compliance, Silicon MOSFET Power Transistor, 175MHz, 12W

**TEST CIRCUIT (f=175MHz)**

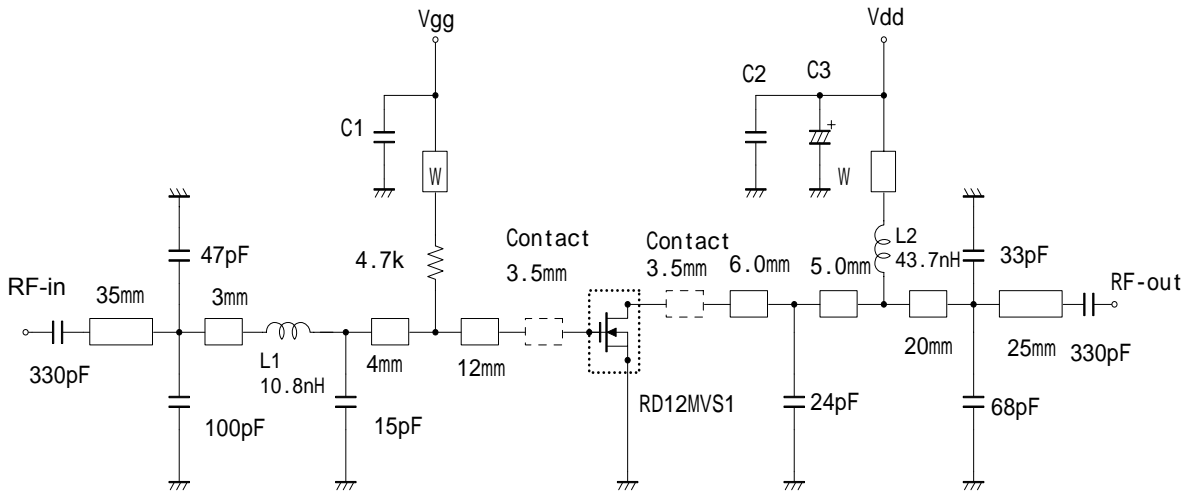

Note: Board material - Teflon substrate

Micro strip line width=2.2mm/50, r:2.7,t=0.8mm

W: line width=1.0mm

Chip Condenser :GRM40

[ ] Copper board spring t=0.1mm

L: Enameled wire

L1:4Turns,D:0.43mm, 1.66mm(outside diameter)

L2:6Turns,D:0.43mm, 2.46mm(outside diameter)

C1, C2: 1000pF

C3: 10uF, 50V

**INPUT / OUTPUT IMPEDANCE VS. FREQUENCY CHARACTERISTICS**

175MHz  $Z_{in}^*$   $Z_{out}^*$

$Z_0=50\Omega$

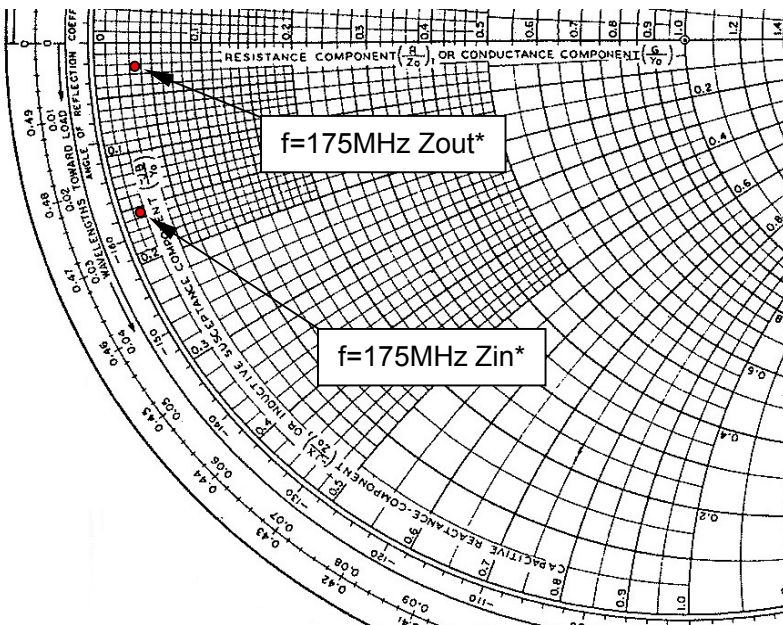

Vdd=7.2V, Idq=1.0A(Vgg adj.), Pin=1.0W

$Z_{in}^*=0.965-j7.73$

$Z_{out}^*=1.73-j1.14$

$Z_{in}^*$ : Complex conjugate of input impedance

$Z_{out}^*$ : Complex conjugate of output impedance



**ELECTROSTATIC SENSITIVE DEVICE**  
OBSERVE HANDLING PRECAUTIONS

MITSUBISHI RF POWER MOS FET

# RD12MVS1

**RoHS Compliance, Silicon MOSFET Power Transistor, 175MHz, 12W**

RD12MVS1 S-PARAMETER DATA (@V<sub>dd</sub>=7.2V, I<sub>d</sub>=900mA)

Freq. [MHz]	S11		S21		S12		S22	
	(mag)	(ang)	(mag)	(ang)	(mag)	(ang)	(mag)	(ang)
25	0.824	-159.3	26.397	93.4	0.018	-3.3	0.761	-160.3
50	0.816	-169.0	13.193	85.2	0.016	1.4	0.765	-168.1
75	0.817	-171.7	8.716	79.3	0.016	-10.9	0.778	-170.7
100	0.829	-172.8	6.537	74.5	0.016	-14.1	0.787	-170.3
125	0.837	-173.4	5.110	68.5	0.016	-18.2	0.800	-171.7
150	0.845	-173.9	4.117	64.2	0.015	-18.3	0.796	-172.3
175	0.852	-174.0	3.402	60.8	0.016	-15.1	0.810	-172.3
200	0.860	-174.3	2.896	57.2	0.012	-30.4	0.836	-172.2
225	0.870	-175.0	2.525	53.2	0.014	-29.9	0.858	-172.2
250	0.876	-175.0	2.175	48.9	0.013	-24.5	0.855	-173.0
275	0.886	-175.6	1.897	46.5	0.012	-39.4	0.859	-173.3
300	0.891	-175.8	1.675	43.6	0.012	-53.1	0.860	-173.4
325	0.902	-175.9	1.496	41.0	0.014	-32.9	0.886	-174.5
350	0.903	-176.2	1.348	38.3	0.012	-32.2	0.898	-174.6
375	0.909	-176.7	1.208	35.7	0.009	-29.2	0.898	-175.0
400	0.907	-177.6	1.087	33.7	0.009	-21.6	0.893	-175.6
425	0.912	-177.9	0.996	31.6	0.009	-32.5	0.903	-175.7
450	0.923	-178.3	0.912	29.7	0.004	-37.2	0.910	-176.6
475	0.928	-178.5	0.836	27.9	0.008	-25.9	0.917	-176.8
500	0.934	-178.6	0.748	25.8	0.007	-21.3	0.925	-177.3
525	0.932	-178.8	0.707	23.6	0.005	-46.6	0.922	-177.6
550	0.936	-179.2	0.647	23.2	0.006	-25.0	0.922	-177.6
575	0.932	179.6	0.591	20.8	0.004	-40.9	0.939	-178.0
600	0.935	179.1	0.562	20.0	0.003	-33.6	0.939	-178.9
625	0.939	179.2	0.520	17.4	0.003	17.7	0.938	-179.3
650	0.939	179.4	0.485	15.5	0.003	25.4	0.930	-179.5
675	0.943	179.1	0.460	15.6	0.003	51.4	0.932	-179.9
700	0.945	178.7	0.435	15.5	0.002	5.7	0.946	-179.9
725	0.943	177.5	0.407	13.3	0.004	5.6	0.949	179.3
750	0.939	177.2	0.380	12.2	0.001	-16.1	0.940	179.0
775	0.943	176.9	0.358	10.8	0.004	58.8	0.935	178.8
800	0.948	176.8	0.327	8.6	0.002	-6.7	0.943	178.2
825	0.951	177.1	0.308	8.0	0.003	40.4	0.945	177.5
850	0.953	176.7	0.314	8.5	0.003	77.0	0.948	176.8
875	0.952	176.1	0.284	7.0	0.006	46.5	0.946	176.7
900	0.954	175.4	0.269	9.7	0.003	64.5	0.950	176.7
925	0.944	174.4	0.254	6.7	0.007	60.3	0.946	176.0
950	0.951	174.6	0.250	6.0	0.006	69.7	0.952	175.7
975	0.954	175.0	0.232	1.9	0.003	80.3	0.959	175.0
1000	0.955	175.0	0.227	7.8	0.003	86.7	0.950	174.8



**ELECTROSTATIC SENSITIVE DEVICE**  
OBSERVE HANDLING PRECAUTIONS

MITSUBISHI RF POWER MOS FET

# RD12MVS1

**RoHS Compliance, Silicon MOSFET Power Transistor, 175MHz, 12W**

RD12MVS1 S-PARAMETER DATA (@Vdd=12.5V, Id=900mA)

Freq. [MHz]	S11		S21		S12		S22	
	(mag)	(ang)	(mag)	(ang)	(mag)	(ang)	(mag)	(ang)
25	0.815	-150.5	31.656	96.3	0.016	0.3	0.700	-150.9
50	0.802	-163.9	15.905	85.5	0.016	-6.2	0.698	-161.8
75	0.803	-167.8	10.443	78.2	0.016	-12.3	0.719	-165.9
100	0.818	-169.7	7.776	72.7	0.016	-16.7	0.732	-164.9
125	0.829	-170.6	6.054	66.0	0.016	-18.7	0.751	-166.6
150	0.838	-171.5	4.816	60.7	0.014	-24.8	0.753	-167.1
175	0.849	-171.6	3.945	57.1	0.014	-27.4	0.784	-167.7
200	0.855	-172.0	3.358	52.9	0.015	-32.9	0.813	-167.8
225	0.869	-172.9	2.872	48.7	0.013	-33.6	0.836	-168.4
250	0.878	-173.7	2.459	44.8	0.013	-27.8	0.839	-168.9
275	0.886	-174.1	2.135	41.8	0.012	-29.3	0.844	-169.9
300	0.898	-174.3	1.876	38.8	0.009	-19.7	0.851	-170.5
325	0.905	-174.5	1.671	36.3	0.011	-46.4	0.873	-171.1
350	0.908	-174.9	1.492	33.5	0.009	-51.2	0.895	-172.0
375	0.915	-175.8	1.329	31.1	0.010	-37.5	0.891	-172.4
400	0.919	-176.6	1.188	28.7	0.007	-39.4	0.898	-172.9
425	0.922	-177.3	1.083	26.9	0.006	-76.7	0.899	-173.5
450	0.926	-177.7	0.974	25.0	0.008	-46.1	0.913	-173.9
475	0.933	-177.7	0.894	23.0	0.005	-48.1	0.925	-174.8
500	0.937	-177.8	0.816	20.9	0.005	-46.9	0.923	-175.1
525	0.940	-178.5	0.745	19.6	0.006	-25.8	0.924	-175.7
550	0.937	-179.3	0.700	18.2	0.004	-45.0	0.923	-175.9
575	0.937	179.7	0.643	16.2	0.007	-49.7	0.940	-176.4
600	0.935	179.7	0.605	14.6	0.004	1.3	0.935	-177.1
625	0.945	179.6	0.549	13.1	0.004	-46.8	0.934	-177.9
650	0.948	179.7	0.510	14.1	0.004	51.2	0.938	-177.9
675	0.951	179.5	0.479	12.6	0.003	32.2	0.937	-178.1
700	0.950	178.9	0.454	9.0	0.003	-36.9	0.943	-178.9
725	0.946	178.0	0.424	8.9	0.003	83.3	0.951	-179.5
750	0.948	177.2	0.382	7.2	0.004	29.6	0.948	-179.9
775	0.947	177.1	0.370	6.0	0.004	47.6	0.944	179.8
800	0.948	176.9	0.357	7.4	0.005	68.7	0.938	179.6
825	0.955	177.1	0.332	4.4	0.005	60.4	0.947	178.7
850	0.958	176.8	0.323	4.9	0.004	66.9	0.949	178.4
875	0.954	176.2	0.301	2.7	0.004	92.7	0.953	178.1
900	0.950	175.3	0.296	2.4	0.003	68.9	0.950	177.8
925	0.947	174.9	0.284	-1.0	0.007	65.3	0.947	177.4
950	0.950	174.9	0.252	-0.5	0.006	87.1	0.947	176.6
975	0.953	174.9	0.251	2.6	0.005	90.1	0.950	176.1
1000	0.959	174.7	0.230	-2.3	0.008	90.1	0.949	175.2



**ELECTROSTATIC SENSITIVE DEVICE**  
OBSERVE HANDLING PRECAUTIONS

**mitsubishi** RF POWER MOS FET

**RD12MVS1**

**RoHS Compliance, Silicon MOSFET Power Transistor, 175MHz, 12W**

---

**Keep safety first in your circuit designs!**

Mitsubishi Electric Corporation puts the maximum effort into making semiconductor products better and more reliable, but there is always the possibility that trouble may occur with them. Trouble with semiconductors may lead to personal injury, fire or property damage. Remember to give due consideration to safety when making your circuit designs, with appropriate measures such as (i) placement of substitutive, auxiliary circuits, (ii) use of non-flammable material or (iii) prevention against any malfunction or mishap.

**Warning!**

Do not use the device at the exceeded the maximum rating condition. In case of plastic molded devices, the exceeded maximum rating condition may cause blowout, smoldering or catch fire of the molding resin due to extreme short current flow between the drain and the source of the device. These results causes in fire or injury.