

Symbol MULTILED® 2.5 mm x 5 mm, Partly Diffused

LU B371

Besondere Merkmale

- nicht eingefärbtes, teilweise diffuses Gehäuse
- Lötspieße im 2.54 mm Raster
- hohe Signalwirkung durch Farbwechsel der LED möglich
- Anzeige unterschiedlicher Betriebszustände durch Farbwechsel von rot auf grün möglich
- beide Farben getrennt ansteuerbar
- Lötspieße mit Aufsetzebene
- gegurtet lieferbar
- Störimpulsfest nach DIN 40839

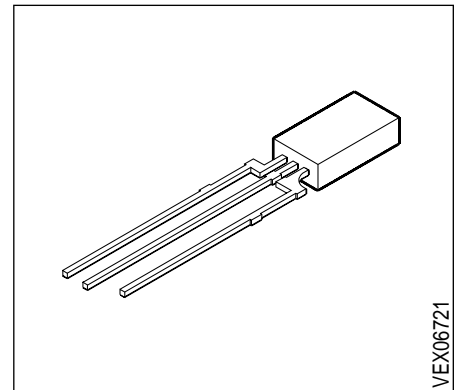

Features

- colorless, partly diffused package
- 2.54 mm lead spacing
- high signal efficiency possible by color change of the LED
- indication of different operation modes is possible by color change of the LED from red to green
- both colors can be controlled separately
- solder leads with stand-off
- available taped on reel
- load dump resistant acc. to DIN 40839

Typ Type	Emissionsfarbe Color of Emission	Gehäusefarbe Color of Package	Lichtstärke Luminous Intensity $I_F = 10 \text{ mA}$ $I_V \text{ (mcd)}$	Bestellnummer Ordering Code
LU B371-FJ	super-red / green	colorless clear	1.0 ... 8.0	Q62703-Q2048
LU B371-GK	super-red / green	partly diffused	1.6 ... 12.5	Q62703-Q2049

Streuung der Lichtstärke in einer Verpackungseinheit $I_{V \max} / I_{V \min} \leq 2.0$.¹⁾

Streuung der Lichtstärke in einer LED $I_{V \max} / I_{V \min} \leq 4.0$ (LU B371 - FJ), ≤ 2.0 (LU B371 - GK).

¹⁾ Bei MULTILED® bestimmt die Helligkeit des jeweils dunkleren Chips in einem Gehäuse die Helligkeitsgruppe der LED.

Luminous intensity ratio in one packaging unit $I_{V \max} / I_{V \min} \leq 2.0$.¹⁾

Luminous intensity ratio in one LED $I_{V \max} / I_{V \min} \leq 4.0$ (LU B371 - FJ), ≤ 2.0 (LU B371 - GK).

¹⁾ In case of MULTILED®, the brightness of the darker chip in one package determines the brightness group of the LED.

Grenzwerte
Maximum Ratings

Bezeichnung Parameter	Symbol Symbol	Werte Values	Einheit Unit
Betriebstemperatur Operating temperature range	T_{op}	- 55 ... + 100	°C
Lagertemperatur Storage temperature range	T_{stg}	- 55 ... + 100	°C
Sperrschichttemperatur Junction temperature	T_j	+ 100	°C
Durchlaßstrom Forward current	I_F	40 ¹⁾	mA
Stoßstrom Surge current $t \leq 10 \mu s, D = 0.005$	I_{FM}	0.5 ¹⁾	A
Verlustleistung Power dissipation $T_A \leq 25 \text{ °C}$	P_{tot}	140 ¹⁾	mW
Wärmewiderstand Thermal resistance Sperrschicht / Luft Junction / air	$R_{th JA}$	400	K/W

¹⁾ Bei gleichzeitigem Betrieb beider Dioden darf die Summe aus Strom und Verlustleistung die angegebenen Grenzen nicht überschreiten.

¹⁾ With simultaneous operation of both diodes the sum of the current and the power dissipation must not exceed the specified limits.

Kennwerte ($T_A = 25\text{ °C}$)

Characteristics

Bezeichnung Parameter	Symbol Symbol	Werte Values		Einheit Unit
		super-red	green	
Wellenlänge des emittierten Lichtes (typ.) Wavelength at peak emission (typ.) $I_F = 20\text{ mA}$	λ_{peak}	635	565	nm
Dominantwellenlänge (typ.) Dominant wavelength (typ.) $I_F = 20\text{ mA}$	λ_{dom}	628	570	nm
Spektrale Bandbreite bei 50 % $I_{\text{rel max}}$ (typ.) Spectral bandwidth at 50 % $I_{\text{rel max}}$ (typ.) $I_F = 20\text{ mA}$	$\Delta\lambda$	45	25	nm
Abstrahlwinkel bei 50 % I_V (Vollwinkel) Viewing angle at 50 % I_V	2ϕ	100	100	Grad deg.
Durchlaßspannung (typ.) Forward voltage (max.) $I_F = 10\text{ mA}$	V_F V_F	2.0 2.6	2.0 2.6	V V
Kapazität (typ.) Capacitance $V_R = 0\text{ V}, f = 1\text{ MHz}$	C_0	12	15	pF
Schaltzeiten: Switching times: I_V from 10 % to 90 % (typ.) I_V from 90 % to 10 % (typ.) $I_F = 100\text{ mA}, t_p = 10\text{ }\mu\text{s}, R_L = 50\text{ }\Omega$	t_r t_f	300 150	450 200	ns ns

Relative spektrale Emission $I_{rel} = f(\lambda)$, $T_A = 25\text{ °C}$, $I_F = 20\text{ mA}$

Relative spectral emission

$V(\lambda)$ = spektrale Augenempfindlichkeit

Standard eye response curve

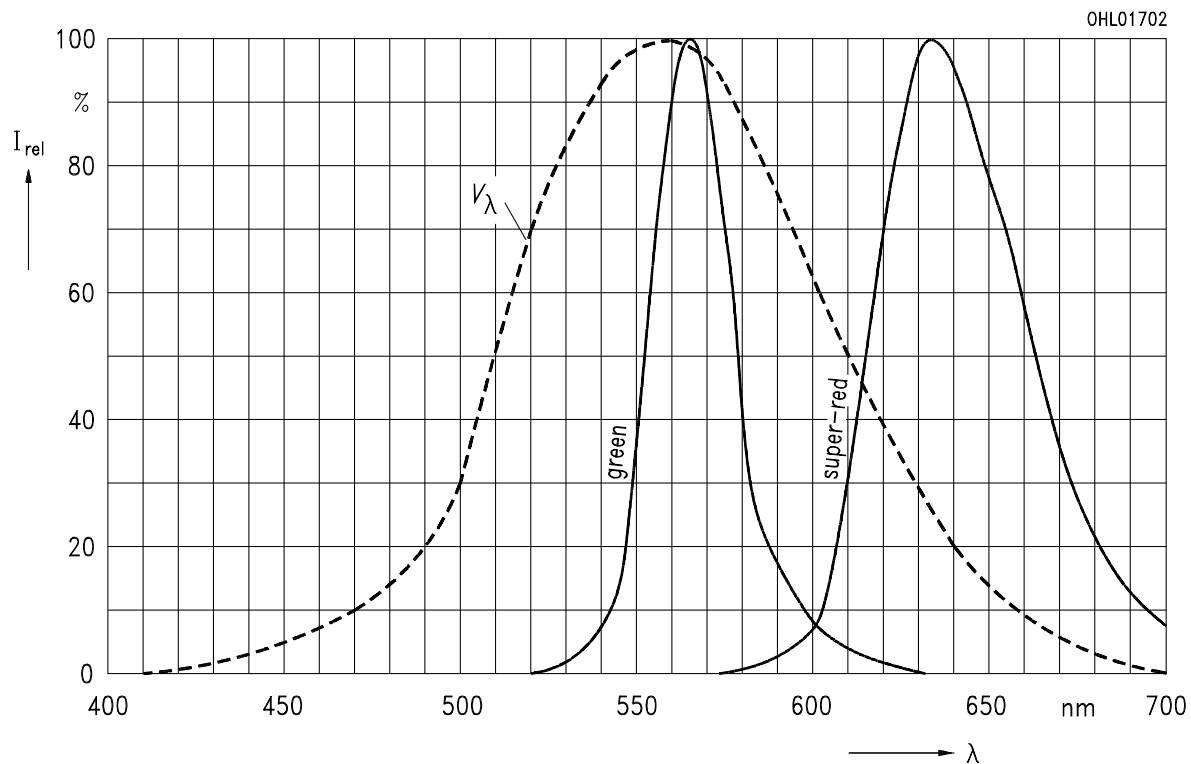

Abstrahlcharakteristik $I_{rel} = f(\varphi)$

Radiation characteristic

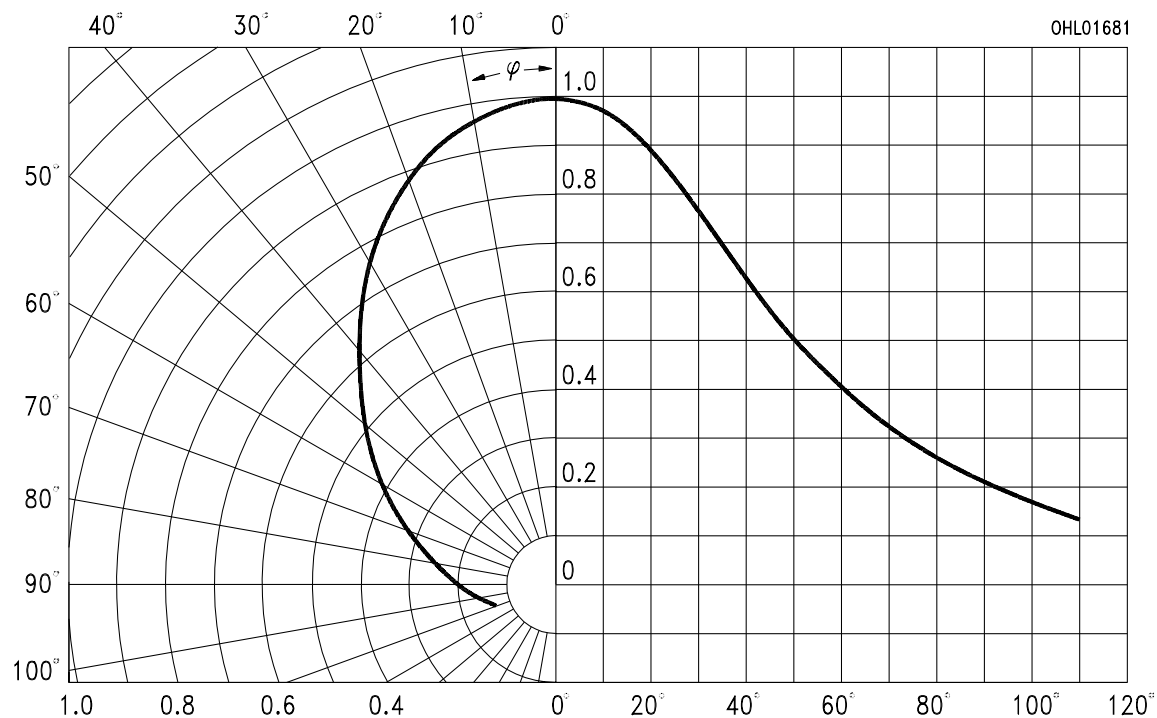

Durchlaßstrom $I_F = f(V_F)$

Forward current

$T_A = 25^\circ\text{C}$

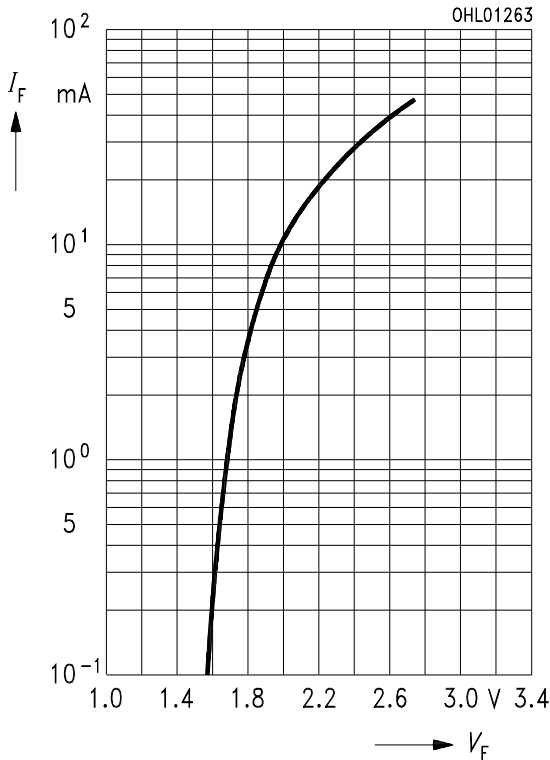

Relative Lichtstärke $I_V/I_{V(10\text{mA})} = f(I_F)$

Relative luminous intensity

$T_A = 25^\circ\text{C}$

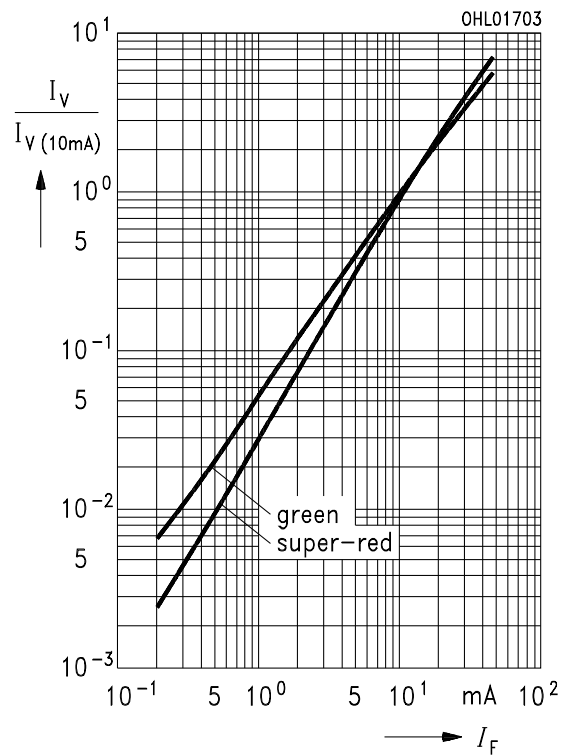

Zulässige Impulsbelastbarkeit $I_F = f(t_p)$

Permissible pulse handling capability

Duty cycle $D =$ parameter, $T_A = 25^\circ\text{C}$

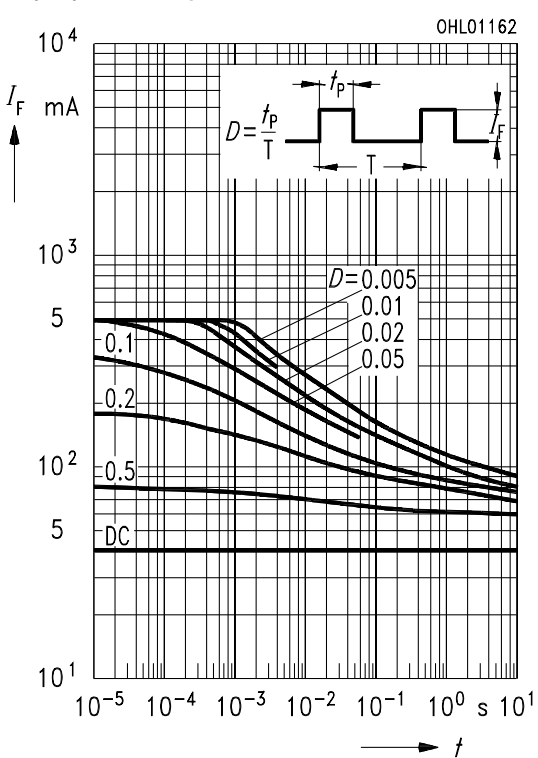

Maximal zulässiger Durchlaßstrom

Max. permissible forward current

$I_F = f(T_A)$

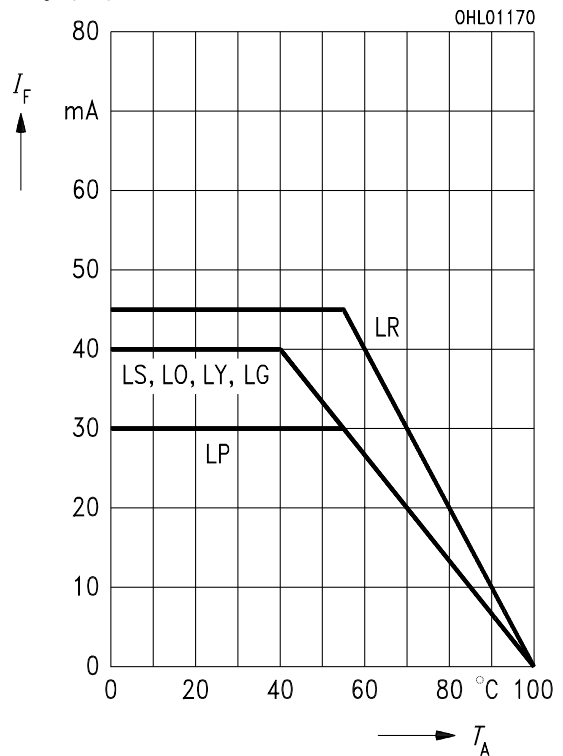

Wellenlänge der Strahlung $\lambda_{\text{peak}} = f(T_A)$
Wavelength at peak emission

$I_F = 20 \text{ mA}$

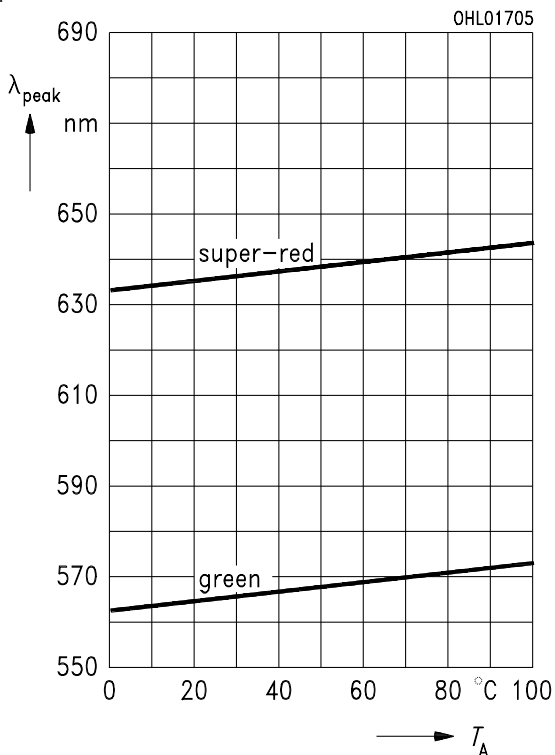

Dominantwellenlänge $\lambda_{\text{dom}} = f(T_A)$
Dominant wavelength

$I_F = 20 \text{ mA}$

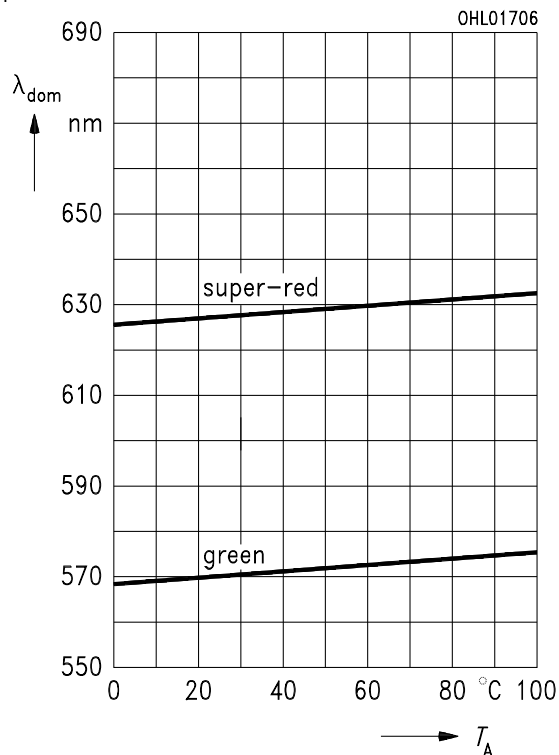

Durchlaßspannung $V_F = f(T_A)$
Forward voltage

$I_F = 10 \text{ mA}$

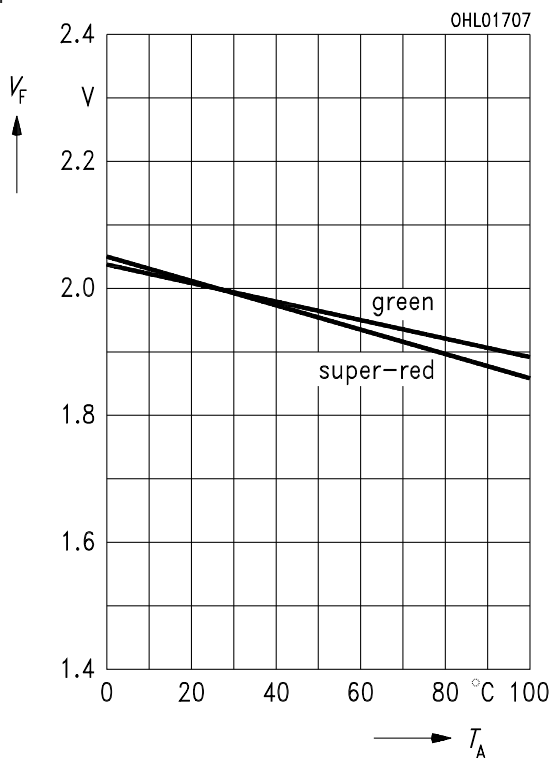

Relative Lichtstärke $I_V/I_{V(25^{\circ}\text{C})} = f(T_A)$
Relative luminous intensity

$I_F = 10 \text{ mA}$

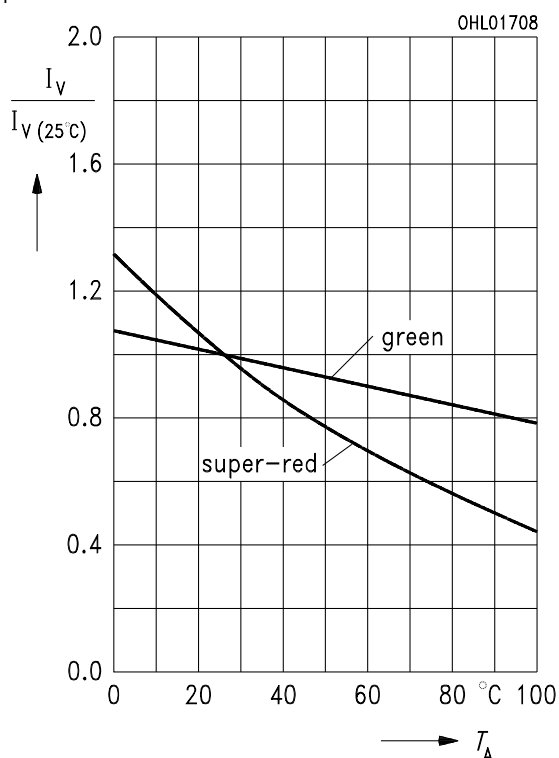

Maßzeichnung (Maße in mm, wenn nicht anders angegeben)
Package Outlines (Dimensions in mm, unless otherwise specified)

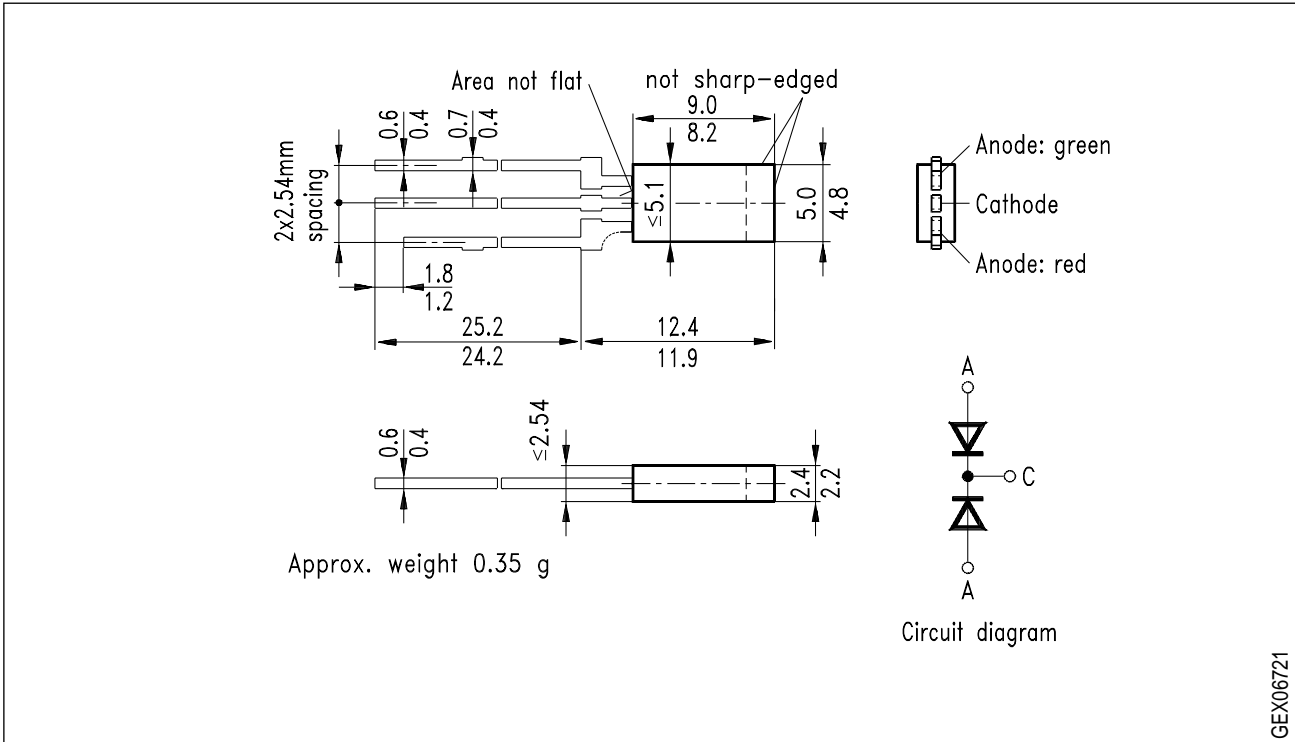

Kathodenkennzeichnung: Mittlerer Lötspieß
Cathode mark: Middle solder lead