

PT495F

Intermediate Acceptance High Sensitivity Phototransistor

■ Features

1. Epoxy resin package type
2. Compact
3. Intermediate acceptance ($\Delta\theta$: TYP. $\pm 40^\circ$)
4. Long lead pin type (MAX. lead length of 51.5 mm)
acceptable to order
5. Visible light cut-off type

■ Applications

1. VCRs
2. Optoelectronic switches

■ Outline Dimensions

(Unit : mm)

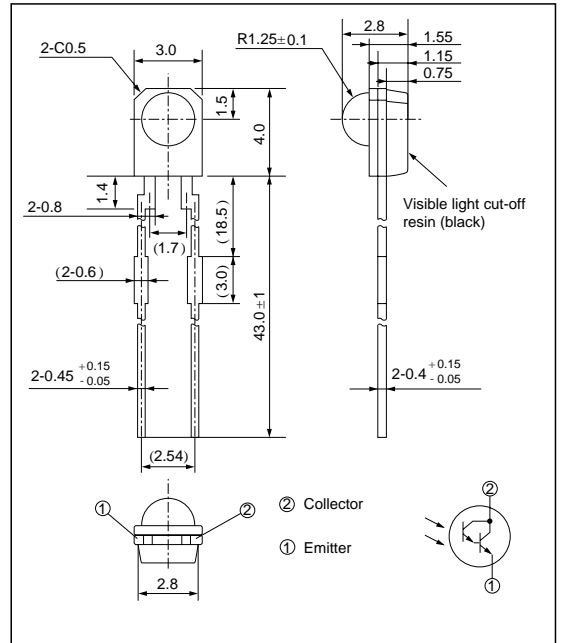

(Note) MAX. lead length of 51.5 mm acceptable to order

■ Absolute Maximum Ratings

(Ta=25°C)

Parameter	Symbol	Rating	Unit
Collector-emitter voltage	V_{CEO}	35	V
Emitter-collector voltage	V_{ECO}	6	V
Collector current	I_C	50	mA
Collector power dissipation	P_C	75	mW
Operating temperature	T_{opr}	-25 to +85	°C
Storage temperature	T_{stg}	-40 to +85	°C
*1 Soldering temperature	T_{sol}	260	°C

*1 1 For 3 seconds at the position of 1.4 mm from the resin edge

■ Electro-optical Characteristics

($T_a=25^\circ\text{C}$)

Parameter	Symbol	Conditions	MIN.	TYP.	MAX.	Unit
*2 Collector current	I_C	$V_{CE} = 2\text{V}, E_v = 2 \text{ lx}$	0.2	-	0.8	mA
Dark current	I_{CEO}	$V_{CE} = 10\text{V}, E_e = 0$	-	-	10^{-6}	A
*2 Collector-emitter saturation voltage	$V_{CE(sat)}$	$I_C = 0.8\text{mA}, E_e = 1\text{mW}/\text{cm}^2$	-	-	1.0	V
Peak sensitivity wavelength	λ_p	-	-	860	-	nm
Response time	Rise	$V_{CE} = 2\text{V}, I_C = 5\text{mA}$	-	80	400	μs
	Fall		-	70	350	
Half intensity angle	$\Delta\theta$	-	-	± 40	-	$^\circ$

*2 E_v, E_e : Illuminance, irradiance by CIE standard light source A (tungsten lamp)

Fig. 1 Collector Power Dissipation vs. Ambient temperature

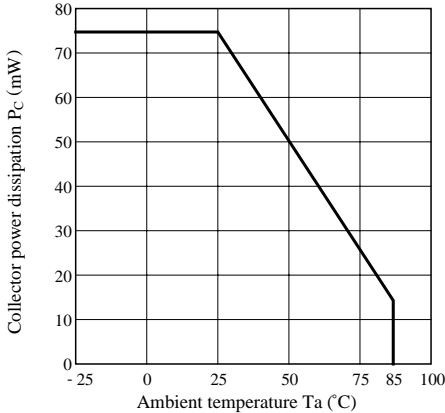

Fig. 2 Dark Current vs. Ambient temperature

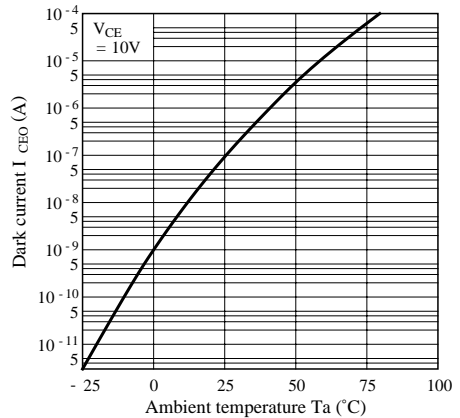

Fig. 3 Relative Collector Current vs. Ambient temperature

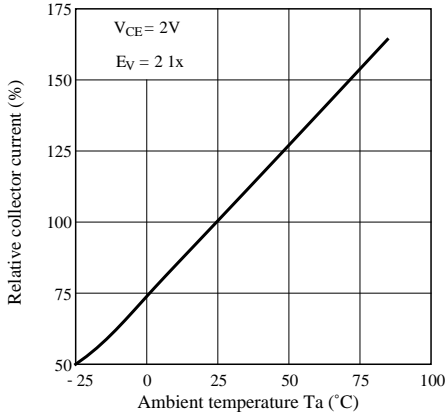

Fig. 4 Collector Current vs. Irradiance

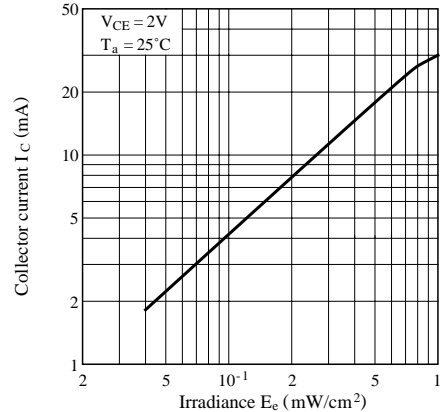

Fig. 5 Collector Current vs. Collector-emitter voltage

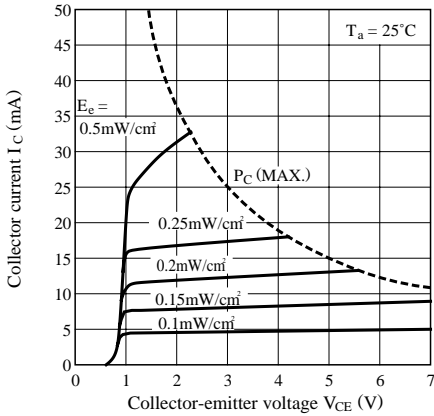

Fig. 6 Spectral Sensitivity

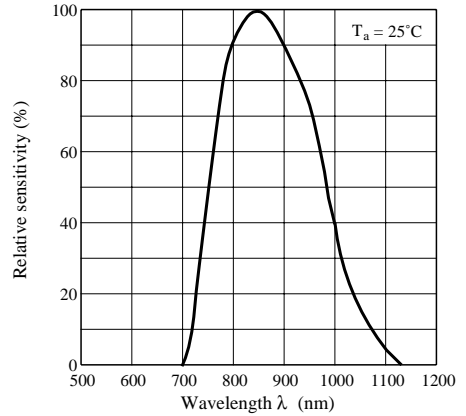
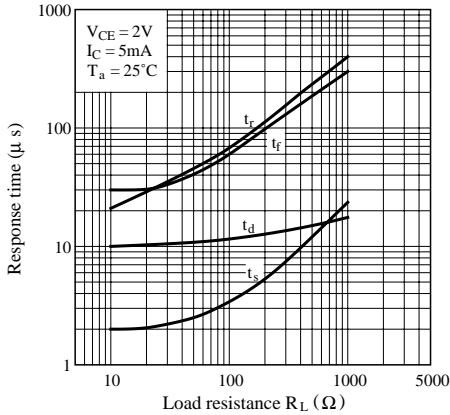

Fig. 7 Response Time vs. Load Resistance



Test Circuit for Response Time

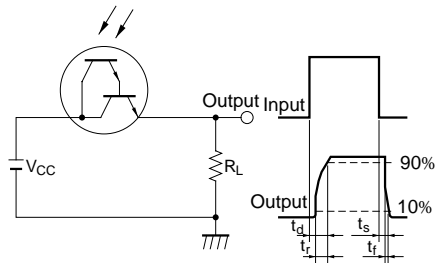

Fig. 8 Radiation Diagram ($T_a = 25^\circ\text{C}$)

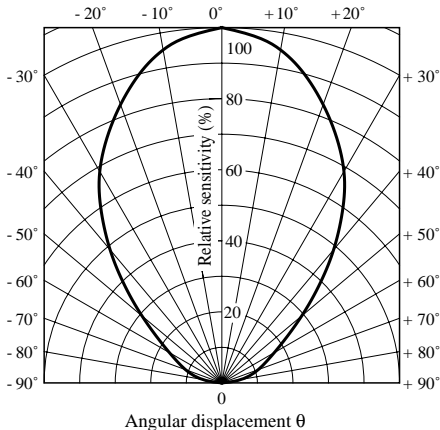

Fig. 9 Collector-emitter Saturation Voltage vs. Irradiance

