

PT480/PT480F

Narrow Acceptance Phototransistor

■ Features

1. Epoxy resin package
2. Narrow acceptance ($\Delta\theta$: TYP. $\pm 13^\circ$)
3. Visible light cut-off type : **PT480F**

■ Applications

1. VCRs, cassette tape recorders
2. Floppy disk drives
3. Optoelectronic switches
4. Automatic stroboscopes

■ Outline Dimensions

(Unit : mm)

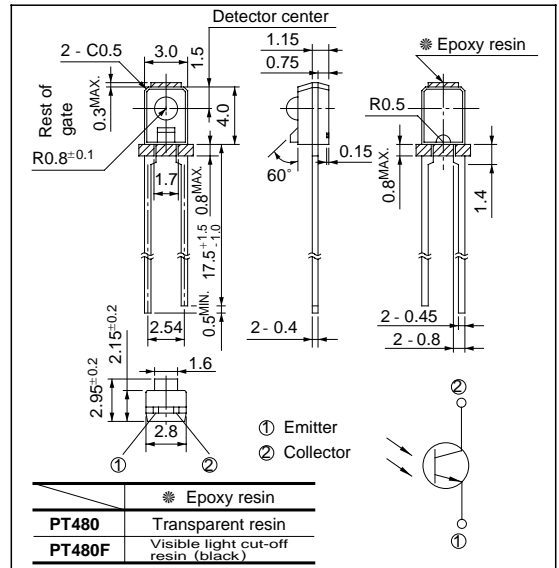

■ Absolute Maximum Ratings

(Ta = 25°C)

Parameter	Symbol	Rating	Unit
Collector-emitter voltage	V _{CEO}	35	V
Emitter-collector voltage	V _{ECO}	6	V
Collector current	I _C	20	mA
Collector power dissipation	P _C	75	mW
Operating temperature	T _{opr}	- 25 to + 85	°C
Storage temperature	T _{stg}	- 40 to + 85	°C
*1 Soldering temperature	T _{sol}	260	°C

*1 For 5 seconds at the position of 1.4mm from the bottom face of resin package

■ Electro-optical Characteristics

(Ta = 25°C)

Parameter	Symbol	Conditions	MIN.	TYP.	MAX.	Unit
*2 Collector current	I _C	V _{CE} = 5V	0.4	1.7	6.0	mA
		E _e = 1mW/cm ²	0.25	0.8	3.0	mA
Collector dark current	I _{CEO}	V _{CE} = 20V, E _e = 0	-	10 ⁻⁹	10 ⁻⁷	A
*2 Collector-emitter saturation voltage	V _{CE(sat)}	I _C = 0.5mA, E _e = 10mW/cm ²	-	0.1	0.4	V
Peak sensitivity wavelength	λ _P	-	-	800	-	nm
			-	860	-	nm
Response time	Rise time	V _{CE} = 2V, I _C = 2mA	-	3	-	μs
	Fall time	R _L = 100Ω	-	3.5	-	μs

*2 E_e : Irradiance by CIE standard light source A (tungsten lamp)

Fig. 1 Collector Power Dissipation vs. Ambient Temperature

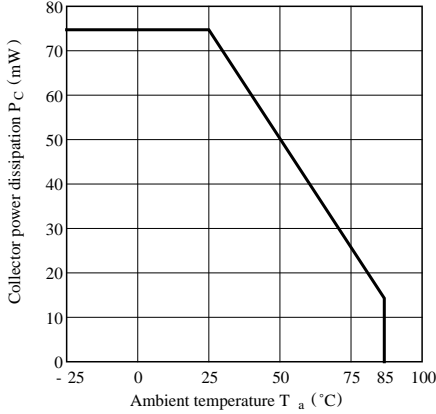

Fig. 2 Collector Dark Current vs. Ambient Temperature

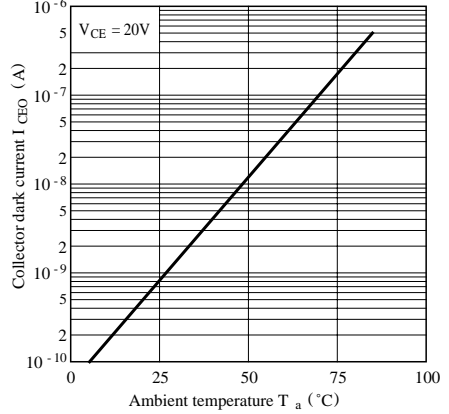

Fig. 3 Relative Collector Current vs. Ambient Temperature

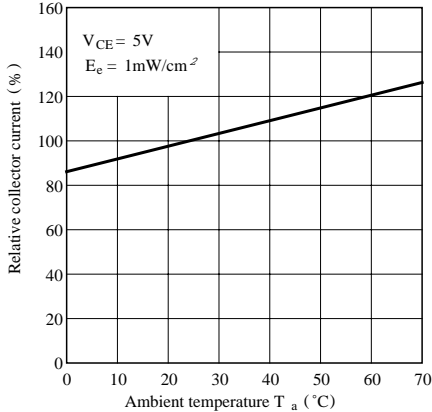

Fig.4-a Collector Current vs. Irradiance (PT480)

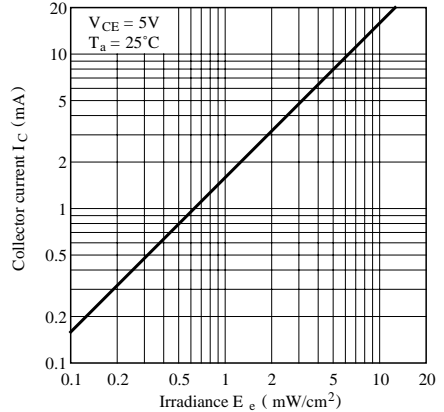

Fig.4-b Collector Current vs. Irradiance (PT480F)

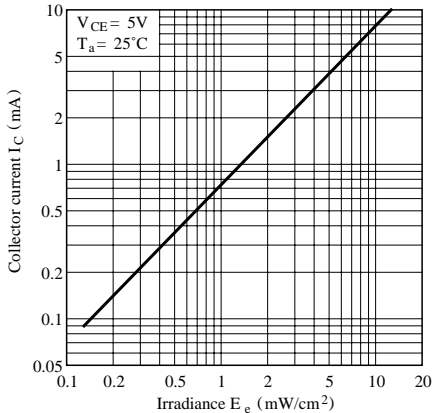

Fig.5-a Collector Current vs. Collector-emitter Voltage (PT480)

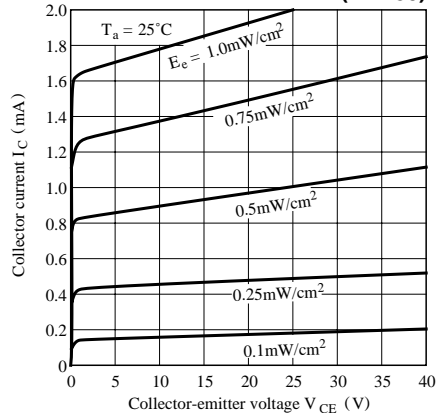

Fig.5-b Collector Current vs. Collector-emitter Voltage (PT480F)

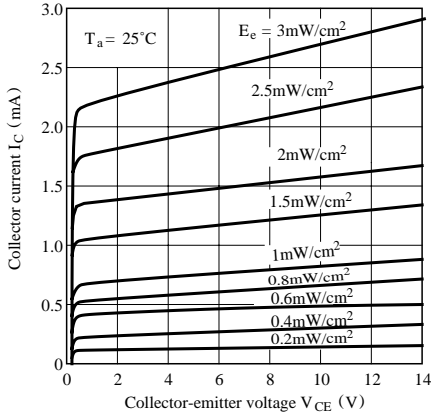

Fig. 6 Spectral Sensitivity

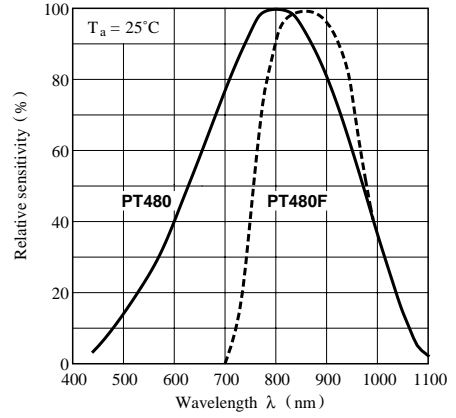
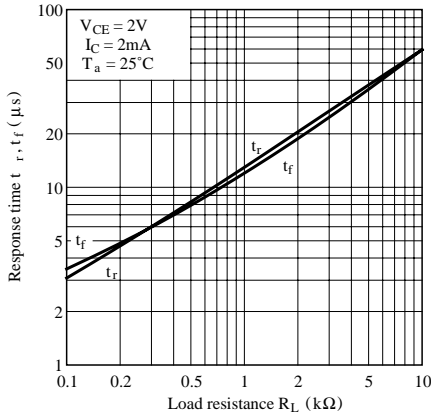

Fig. 7 Response Time vs. Load Resistance



Test Circuit for Response Time

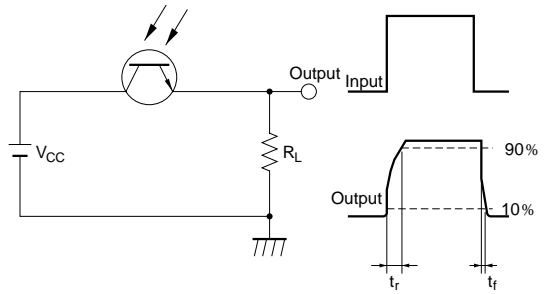

Fig. 8 Sensitivity Diagram (Ta = 25°C)

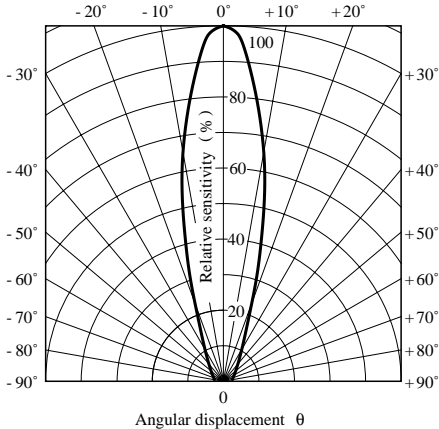

Fig.9-a Collector-emitter Saturation Voltage vs. Irradiance (PT480)

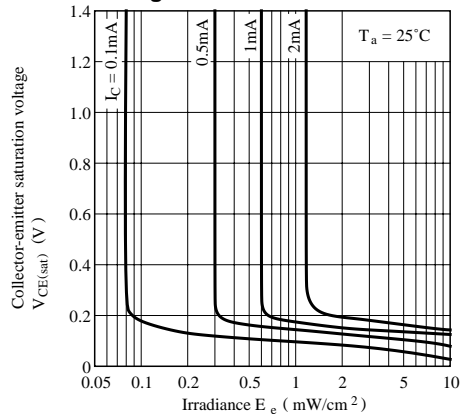

Fig.9-b Collector-emitter Saturation Voltage vs. Irradiance (PT480F)

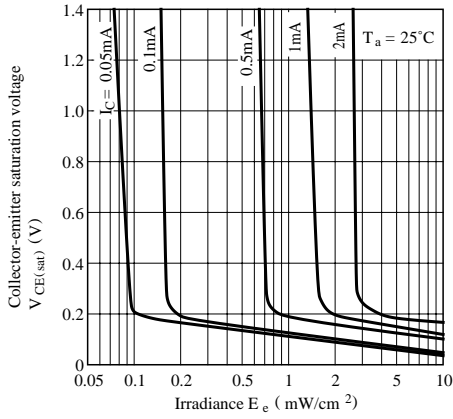
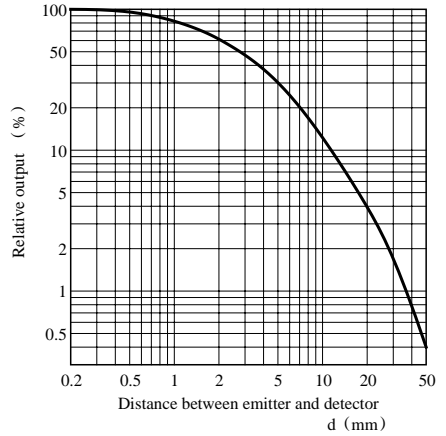

Fig.10 Relative Output vs. Distance (Emitter : GL480)



Please refer to the chapter “Precautions for Use.”