

# PH8230E

N-channel TrenchMOS™ enhanced logic level FET

Rev. 03 — 02 March 2004

Product data

## 1. Product profile

### 1.1 Description

N-channel enhancement mode field-effect power transistor in a plastic package using TrenchMOS™ technology.

### 1.2 Features

- Low thermal resistance
- Low gate drive
- SO8 equivalent area footprint
- Low on-state resistance.

### 1.3 Applications

- DC-to-DC converters
- Portable appliances
- Switched-mode power supplies
- Notebook computers.

### 1.4 Quick reference data

- $V_{DS} \leq 30\text{ V}$
- $I_D \leq 67\text{ A}$
- $P_{tot} \leq 62.5\text{ W}$
- $R_{DSon} \leq 8.2\text{ m}\Omega$

## 2. Pinning information

Table 1: Pinning - SOT669 (LFAK), simplified outline and symbol

Pin	Description	Simplified outline	Symbol
1,2,3	source (s)	<p>Top view MBL286</p> <p><b>SOT669 (LFAK)</b></p>	<p>MBB076</p>
4	gate (g)		
mb	mounting base; connected to drain (d)		



PHILIPS

### 3. Ordering information

Table 2: Ordering information

Type number	Package		Version
	Name	Description	
PH8230E	LFPAK	Plastic single-ended surface mounted package; 4 leads	SOT669

### 4. Limiting values

Table 3: Limiting values

In accordance with the Absolute Maximum Rating System (IEC 60134).

Symbol	Parameter	Conditions	Min	Max	Unit
$V_{DS}$	drain-source voltage (DC)	$25\text{ °C} \leq T_j \leq 150\text{ °C}$	-	30	V
$V_{GS}$	gate-source voltage (DC)		-	$\pm 20$	V
$I_D$	drain current (DC)	$T_{mb} = 25\text{ °C}; V_{GS} = 10\text{ V};$ <a href="#">Figure 2 and 3</a>	-	67	A
		$T_{mb} = 100\text{ °C}; V_{GS} = 10\text{ V};$ <a href="#">Figure 2</a>	-	42	A
$I_{DM}$	peak drain current	$T_{mb} = 25\text{ °C};$ pulsed; $t_p \leq 10\text{ }\mu\text{s};$ <a href="#">Figure 3</a>	-	268	A
$P_{tot}$	total power dissipation	$T_{mb} = 25\text{ °C};$ <a href="#">Figure 1</a>	-	62.5	W
$T_{stg}$	storage temperature		-55	+150	°C
$T_j$	junction temperature		-55	+150	°C
<b>Source-drain diode</b>					
$I_S$	source (diode forward) current (DC)	$T_{mb} = 25\text{ °C}$	-	52	A
$I_{SM}$	peak source (diode forward) current	$T_{mb} = 25\text{ °C};$ pulsed; $t_p \leq 10\text{ }\mu\text{s}$	-	150	A
<b>Avalanche ruggedness</b>					
$E_{DS(AL)S}$	non-repetitive drain-source avalanche energy	unclamped inductive load; $I_D = 33.9\text{ A};$ $t_p = 0.15\text{ ms}; V_{DD} = 30\text{ V}; V_{GS} = 10\text{ V};$ starting $T_j = 25\text{ °C}$	-	115	mJ

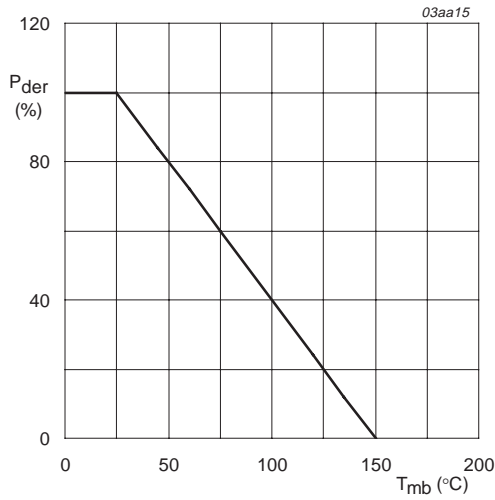

$$P_{der} = \frac{P_{tot}}{P_{tot(25^{\circ}C)}} \times 100\%$$

Fig 1. Normalized total power dissipation as a function of mounting base temperature.

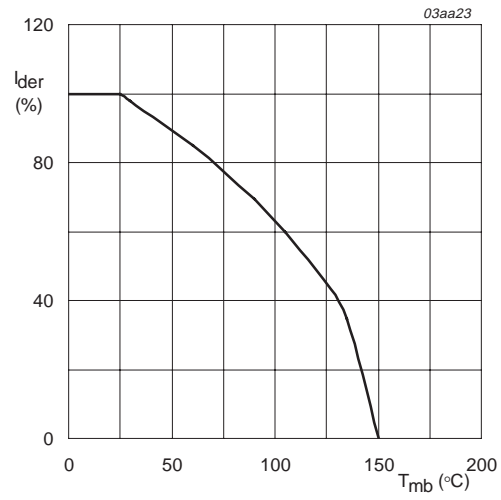

V<sub>GS</sub> ≥ 10 V

$$I_{der} = \frac{I_D}{I_{D(25^{\circ}C)}} \times 100\%$$

Fig 2. Normalized continuous drain current as a function of mounting base temperature.

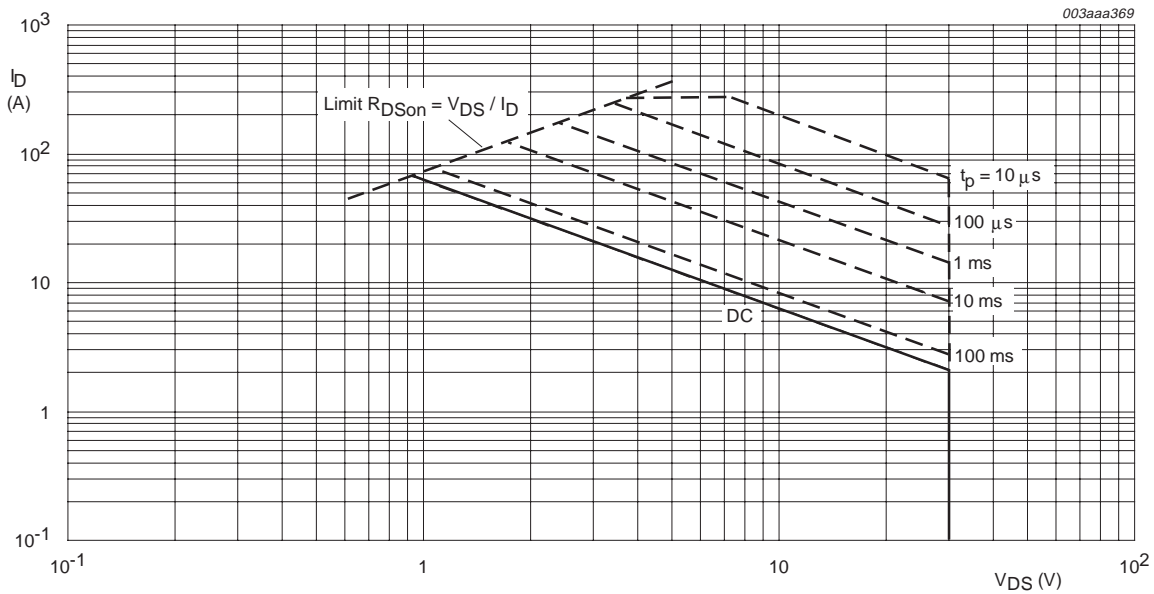

T<sub>mb</sub> = 25 °C; I<sub>DM</sub> is single pulse; V<sub>GS</sub> = 10 V

Fig 3. Safe operating area; continuous and peak drain currents as a function of drain-source voltage.

## 5. Thermal characteristics

Table 4: Thermal characteristics

Symbol	Parameter	Conditions	Min	Typ	Max	Unit
$R_{th(j-mb)}$	thermal resistance from junction to mounting base	Figure 4	-	-	2	K/W

### 5.1 Transient thermal impedance

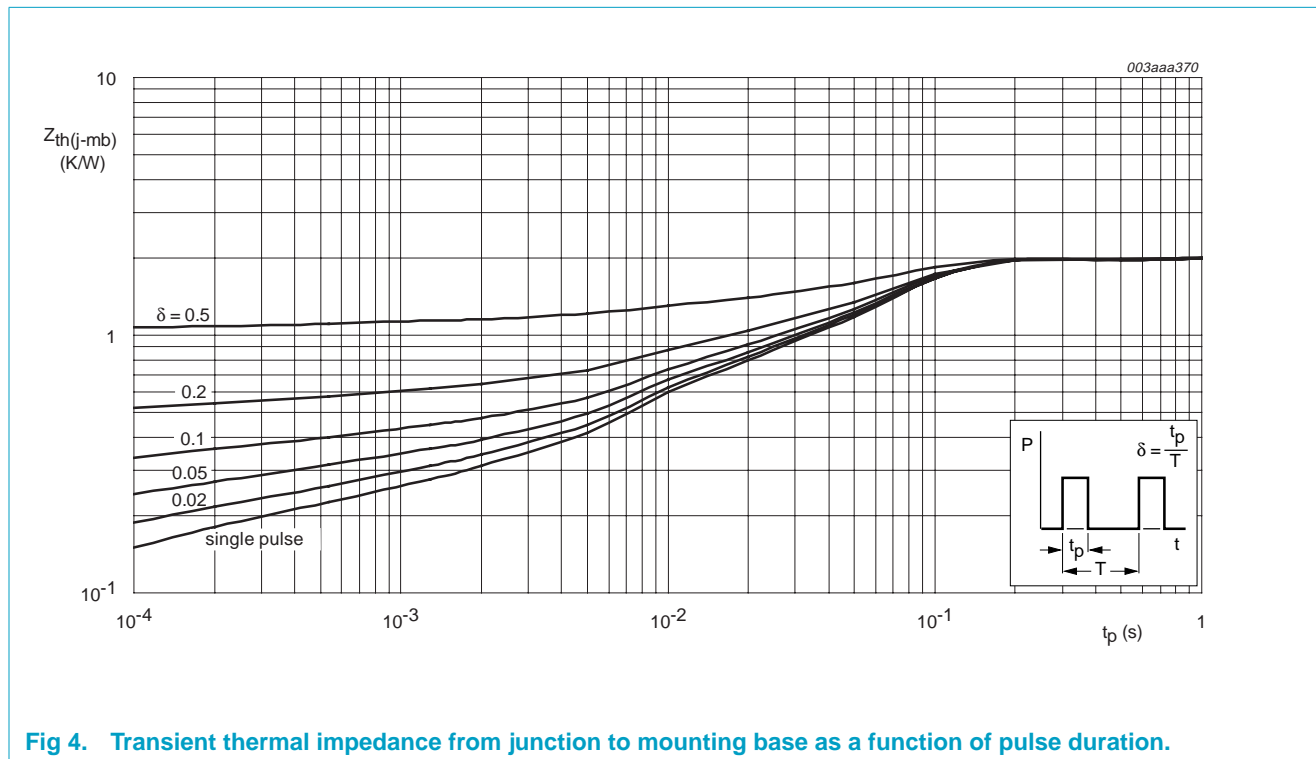
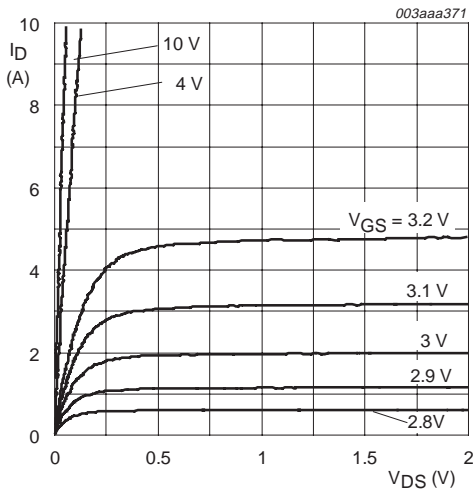

Fig 4. Transient thermal impedance from junction to mounting base as a function of pulse duration.

## 6. Characteristics

**Table 5: Characteristics**
*T<sub>j</sub> = 25 °C unless otherwise specified.*

Symbol	Parameter	Conditions	Min	Typ	Max	Unit
<b>Static characteristics</b>						
V <sub>(BR)DSS</sub>	drain-source breakdown voltage	I <sub>D</sub> = 250 μA; V <sub>GS</sub> = 0 V	30	-	-	V
V <sub>GS(th)</sub>	gate-source threshold voltage	I <sub>D</sub> = 1 mA; V <sub>DS</sub> = V <sub>GS</sub> ; <b>Figure 9</b>				
		T <sub>j</sub> = 25 °C	1	1.7	2.5	V
		T <sub>j</sub> = 150 °C	0.5	-	-	V
I <sub>DSS</sub>	drain-source leakage current	V <sub>DS</sub> = 30 V; V <sub>GS</sub> = 0 V				
		T <sub>j</sub> = 25 °C	-	0.06	1	μA
		T <sub>j</sub> = 150 °C	-	-	500	μA
I <sub>GSS</sub>	gate-source leakage current	V <sub>GS</sub> = ±20 V; V <sub>DS</sub> = 0 V	-	20	100	nA
R <sub>DS(on)</sub>	drain-source on-state resistance	V <sub>GS</sub> = 10 V; I <sub>D</sub> = 10 A; <b>Figure 7 and 8</b>				
		T <sub>j</sub> = 25 °C	-	7.6	8.2	mΩ
		T <sub>j</sub> = 150 °C	-	13	14	mΩ
		V <sub>GS</sub> = 4.5 V; I <sub>D</sub> = 10 A; <b>Figure 8</b>	-	11	13.2	mΩ
<b>Dynamic characteristics</b>						
Q <sub>g(tot)</sub>	total gate charge	I <sub>D</sub> = 20 A; V <sub>DD</sub> = 10 V; V <sub>GS</sub> = 5 V; <b>Figure 13</b>	-	14	-	nC
Q <sub>gs</sub>	gate-source charge		-	5.7	-	nC
Q <sub>gd</sub>	gate-drain (Miller) charge		-	5	-	nC
C <sub>iss</sub>	input capacitance	V <sub>GS</sub> = 0 V; V <sub>DS</sub> = 10 V; f = 1 MHz; <b>Figure 11</b>	-	1400	-	pF
C <sub>oss</sub>	output capacitance		-	527	-	pF
C <sub>rss</sub>	reverse transfer capacitance		-	235	-	pF
t <sub>d(on)</sub>	turn-on delay time	V <sub>DD</sub> = 10 V; I <sub>D</sub> = 10 A; V <sub>GS</sub> = 4.5 V; R <sub>G</sub> = 4.7 Ω	-	28	-	ns
t <sub>r</sub>	rise time		-	44	-	ns
t <sub>d(off)</sub>	turn-off delay time		-	33	-	ns
t <sub>f</sub>	fall time		-	21	-	ns
<b>Source-drain diode</b>						
V <sub>SD</sub>	source-drain (diode forward) voltage	I <sub>S</sub> = 10 A; V <sub>GS</sub> = 0 V; <b>Figure 12</b>	-	0.85	1.2	V
t <sub>rr</sub>	reverse recovery time	I <sub>S</sub> = 20 A; dI <sub>S</sub> /dt = -100 A/μs; V <sub>DS</sub> = 20 V V <sub>GS</sub> = 0 V	-	38	-	ns



$T_j = 25^\circ\text{C}$

Fig 5. Output characteristics: drain current as a function of drain-source voltage; typical values.

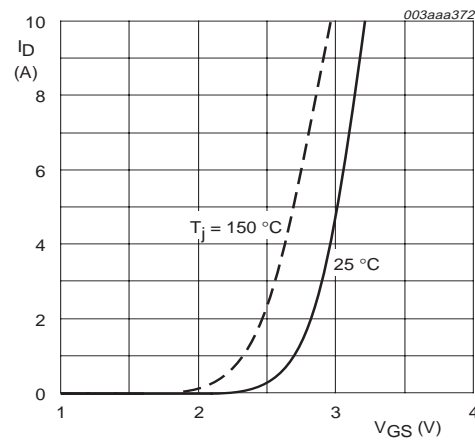

$T_j = 25^\circ\text{C}$  and  $150^\circ\text{C}$ ;  $V_{DS} > I_D \times R_{DSon}$

Fig 6. Transfer characteristics: drain current as a function of gate-source voltage; typical values.

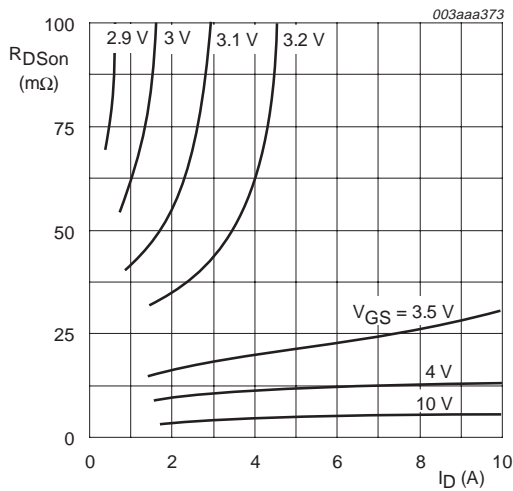

$T_j = 25^\circ\text{C}$

Fig 7. Drain-source on-state resistance as a function of drain current; typical values.

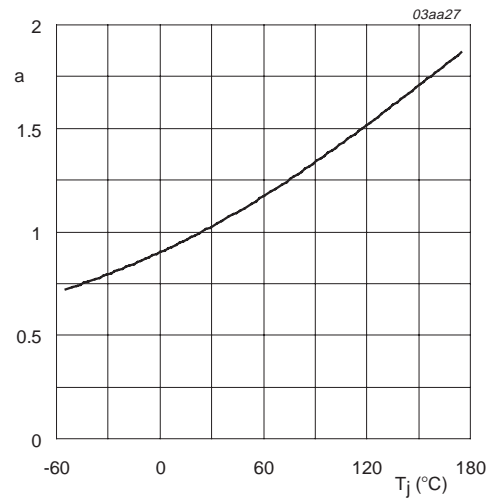

$$a = \frac{R_{DSon}}{R_{DSon}(25^\circ\text{C})}$$

Fig 8. Normalized drain-source on-state resistance factor as a function of junction temperature.

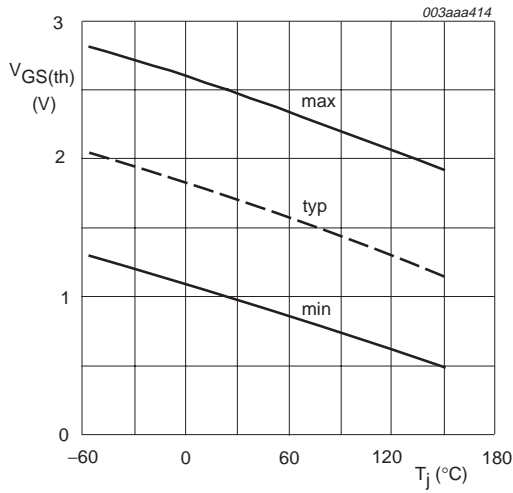

$I_D = 1 \text{ mA}; V_{DS} = V_{GS}$

Fig 9. Gate-source threshold voltage as a function of junction temperature.

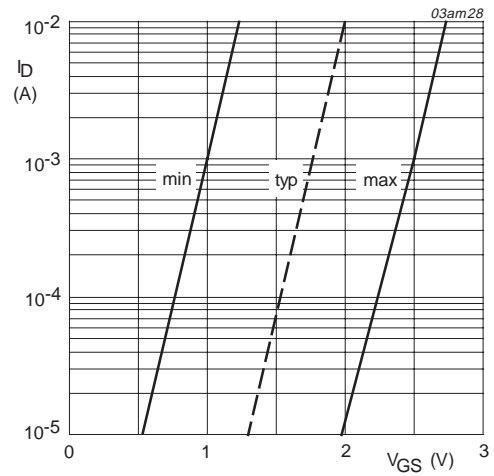

$T_j = 25 \text{ }^{\circ}C; V_{DS} = 5 \text{ V}$

Fig 10. Sub-threshold drain current as a function of gate-source voltage.

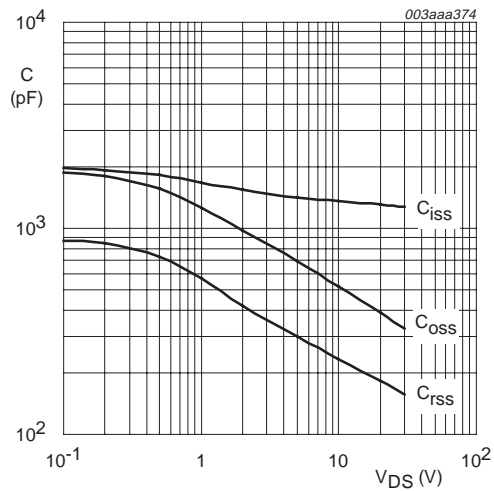

$V_{GS} = 0 \text{ V}; f = 1 \text{ MHz}$

Fig 11. Input, output and reverse transfer capacitances as a function of drain-source voltage; typical values.

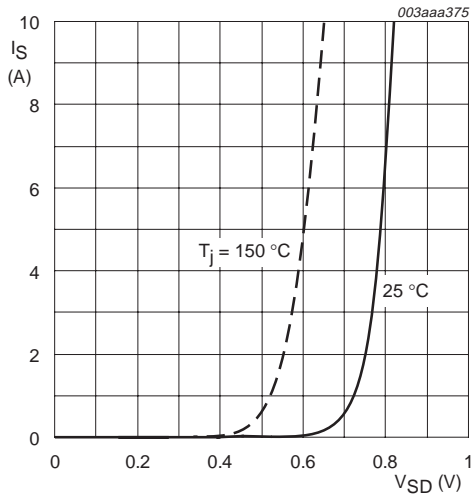

$T_j = 25^\circ\text{C}$  and  $150^\circ\text{C}$ ;  $V_{GS} = 0\text{ V}$

**Fig 12. Source (diode forward) current as a function of source-drain (diode forward) voltage; typical values.**

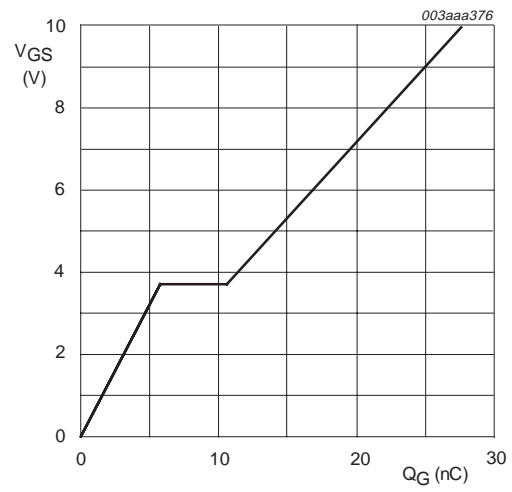

$I_D = 20\text{ A}$ ;  $V_{DD} = 10\text{ V}$

**Fig 13. Gate-source voltage as a function of gate charge; typical values.**



7. Package outline

Plastic single-ended surface mounted package (Philips version LFPAK); 4 leads

SOT669

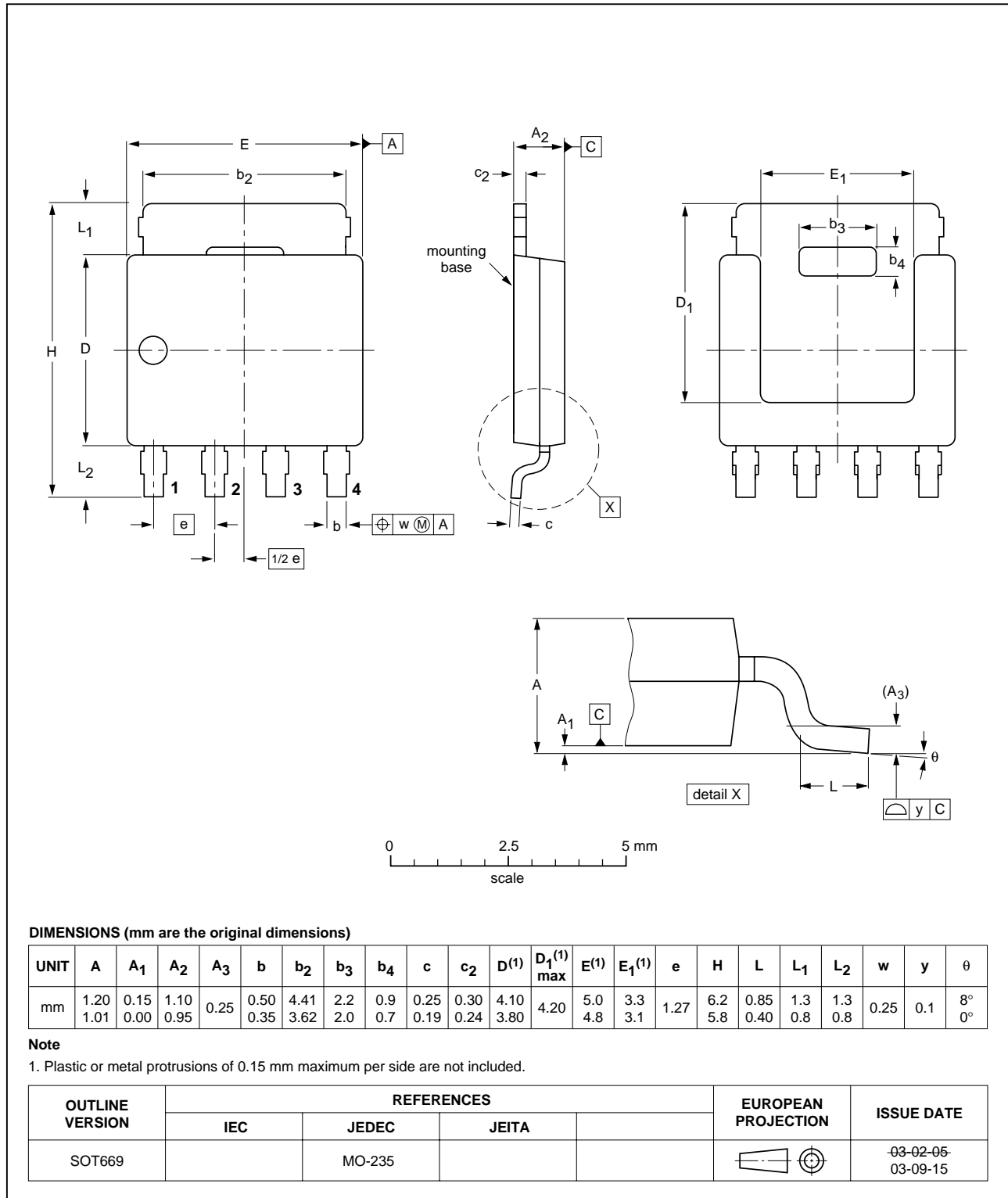

Fig 14. SOT669 (LFPAK).

## 8. Revision history

Table 6: Revision history

Rev	Date	CPCN	Description
03	20040302	-	<b>Product data (9397 750 12946)</b> Modifications: <ul style="list-style-type: none"><li>• <math>t_r</math> data revised in <a href="#">Table 5 “Characteristics”</a></li></ul>
02	20030429	-	<b>Product data (9397 750 11388)</b> Modifications: <ul style="list-style-type: none"><li>• Avalanche ruggedness data added in <a href="#">Table 3</a></li><li>• <math>Q_{g(\text{tot})}</math> data revised in <a href="#">Table 5</a></li><li>• <math>I_{GSS}</math> data revised in <a href="#">Table 5</a></li></ul>
01	20030304	-	<b>Preliminary data (9397 750 11145)</b>

## 9. Data sheet status

Level	Data sheet status <sup>[1]</sup>	Product status <sup>[2][3]</sup>	Definition
I	Objective data	Development	This data sheet contains data from the objective specification for product development. Philips Semiconductors reserves the right to change the specification in any manner without notice.
II	Preliminary data	Qualification	This data sheet contains data from the preliminary specification. Supplementary data will be published at a later date. Philips Semiconductors reserves the right to change the specification without notice, in order to improve the design and supply the best possible product.
III	Product data	Production	This data sheet contains data from the product specification. Philips Semiconductors reserves the right to make changes at any time in order to improve the design, manufacturing and supply. Relevant changes will be communicated via a Customer Product/Process Change Notification (CPCN).

[1] Please consult the most recently issued data sheet before initiating or completing a design.

[2] The product status of the device(s) described in this data sheet may have changed since this data sheet was published. The latest information is available on the Internet at URL <http://www.semiconductors.philips.com>.

[3] For data sheets describing multiple type numbers, the highest-level product status determines the data sheet status.

## 10. Definitions

**Short-form specification** — The data in a short-form specification is extracted from a full data sheet with the same type number and title. For detailed information see the relevant data sheet or data handbook.

**Limiting values definition** — Limiting values given are in accordance with the Absolute Maximum Rating System (IEC 60134). Stress above one or more of the limiting values may cause permanent damage to the device. These are stress ratings only and operation of the device at these or at any other conditions above those given in the Characteristics sections of the specification is not implied. Exposure to limiting values for extended periods may affect device reliability.

**Application information** — Applications that are described herein for any of these products are for illustrative purposes only. Philips Semiconductors make no representation or warranty that such applications will be suitable for the specified use without further testing or modification.

## 11. Disclaimers

**Life support** — These products are not designed for use in life support appliances, devices, or systems where malfunction of these products can reasonably be expected to result in personal injury. Philips Semiconductors

customers using or selling these products for use in such applications do so at their own risk and agree to fully indemnify Philips Semiconductors for any damages resulting from such application.

**Right to make changes** — Philips Semiconductors reserves the right to make changes in the products - including circuits, standard cells, and/or software - described or contained herein in order to improve design and/or performance. When the product is in full production (status 'Production'), relevant changes will be communicated via a Customer Product/Process Change Notification (CPCN). Philips Semiconductors assumes no responsibility or liability for the use of any of these products, conveys no licence or title under any patent, copyright, or mask work right to these products, and makes no representations or warranties that these products are free from patent, copyright, or mask work right infringement, unless otherwise specified.

## 12. Trademarks

**TrenchMOS** — is a trademark of Koninklijke Philips Electronics N.V.

## Contact information

For additional information, please visit <http://www.semiconductors.philips.com>.

For sales office addresses, send e-mail to: [sales.addresses@www.semiconductors.philips.com](mailto:sales.addresses@www.semiconductors.philips.com).

Fax: +31 40 27 24825

## Contents

<b>1</b>	<b>Product profile</b> .....	<b>1</b>
1.1	Description .....	1
1.2	Features .....	1
1.3	Applications .....	1
1.4	Quick reference data .....	1
<b>2</b>	<b>Pinning information</b> .....	<b>1</b>
<b>3</b>	<b>Ordering information</b> .....	<b>2</b>
<b>4</b>	<b>Limiting values</b> .....	<b>2</b>
<b>5</b>	<b>Thermal characteristics</b> .....	<b>4</b>
5.1	Transient thermal impedance .....	4
<b>6</b>	<b>Characteristics</b> .....	<b>5</b>
<b>7</b>	<b>Package outline</b> .....	<b>9</b>
<b>8</b>	<b>Revision history</b> .....	<b>10</b>
<b>9</b>	<b>Data sheet status</b> .....	<b>11</b>
<b>10</b>	<b>Definitions</b> .....	<b>11</b>
<b>11</b>	<b>Disclaimers</b> .....	<b>11</b>
<b>12</b>	<b>Trademarks</b> .....	<b>11</b>

© Koninklijke Philips Electronics N.V. 2004.  
Printed in The Netherlands

All rights are reserved. Reproduction in whole or in part is prohibited without the prior written consent of the copyright owner.

The information presented in this document does not form part of any quotation or contract, is believed to be accurate and reliable and may be changed without notice. No liability will be accepted by the publisher for any consequence of its use. Publication thereof does not convey nor imply any license under patent- or other industrial or intellectual property rights.

Date of release: 02 March 2004

Document order number: 9397 750 12946



# PHILIPS

*Let's make things better.*