

NTMD3P03R2

Power MOSFET -3.05 Amps, -30 Volts Dual P-Channel SOIC-8

Features

- High Efficiency Components in a Dual SOIC-8 Package
- High Density Power MOSFET with Low $R_{DS(on)}$
- Miniature SOIC-8 Surface Mount Package – Saves Board Space
- Diode Exhibits High Speed with Soft Recovery
- I_{DSS} Specified at Elevated Temperature
- Avalanche Energy Specified
- Mounting Information for the SOIC-8 Package is Provided
- Pb-Free Package is Available

Applications

- DC-DC Converters
- Low Voltage Motor Control
- Power Management in Portable and Battery-Powered Products, i.e.: Computers, Printers, PCMCIA Cards, Cellular & Cordless Telephones

MAXIMUM RATINGS ($T_J = 25^\circ\text{C}$ unless otherwise noted)

| Rating | Symbol | Value | Unit |
|---|--|---------------------------------------|--|
| Drain-to-Source Voltage | V_{DSS} | -30 | V |
| Gate-to-Source Voltage – Continuous | V_{GS} | ± 20 | V |
| Thermal Resistance – Junction-to-Ambient (Note 1) Total Power Dissipation @ $T_A = 25^\circ\text{C}$ Continuous Drain Current @ 25°C Continuous Drain Current @ 70°C Pulsed Drain Current (Note 4) | $R_{\theta JA}$ P_D I_D I_D I_{DM} | 171 0.73 -2.34 -1.87 -8.0 | $^\circ\text{C/W}$ W A A A |
| Thermal Resistance – Junction-to-Ambient (Note 2) Total Power Dissipation @ $T_A = 25^\circ\text{C}$ Continuous Drain Current @ 25°C Continuous Drain Current @ 70°C Pulsed Drain Current (Note 4) | $R_{\theta JA}$ P_D I_D I_D I_{DM} | 100 1.25 -3.05 -2.44 -12 | $^\circ\text{C/W}$ W A A A |
| Thermal Resistance – Junction-to-Ambient (Note 3) Total Power Dissipation @ $T_A = 25^\circ\text{C}$ Continuous Drain Current @ 25°C Continuous Drain Current @ 70°C Pulsed Drain Current (Note 4) | $R_{\theta JA}$ P_D I_D I_D I_{DM} | 62.5 2.0 -3.86 -3.1 -15 | $^\circ\text{C/W}$ W A A A |
| Operating and Storage Temperature Range | T_J, T_{stg} | -55 to +150 | $^\circ\text{C}$ |
| Single Pulse Drain-to-Source Avalanche Energy – Starting $T_J = 25^\circ\text{C}$ ($V_{DD} = -30\text{ Vdc}$, $V_{GS} = -4.5\text{ Vdc}$, Peak $I_L = -7.5\text{ Apk}$, $L = 5\text{ mH}$, $R_G = 25\ \Omega$) | E_{AS} | 140 | mJ |
| Maximum Lead Temperature for Soldering Purposes, 1/8" from case for 10 seconds | T_L | 260 | $^\circ\text{C}$ |

Maximum ratings are those values beyond which device damage can occur. Maximum ratings applied to the device are individual stress limit values (not normal operating conditions) and are not valid simultaneously. If these limits are exceeded, device functional operation is not implied, damage may occur and reliability may be affected.

1. Minimum FR-4 or G-10 PCB, $t = \text{Steady State}$.
2. Mounted onto a 2" square FR-4 Board (1 in sq, 2 oz Cu 0.06" thick single sided), $t = \text{steady state}$.
3. Mounted onto a 2" square FR-4 Board (1 in sq, 2 oz Cu 0.06" thick single sided), $t \leq 10$ seconds.
4. Pulse Test: Pulse Width = 300 μs , Duty Cycle = 2%.



ON Semiconductor®

<http://onsemi.com>

| V_{DSS} | $R_{DS(on)}$ Typ | I_D Max |
|-----------|-----------------------|-----------|
| -30 V | 85 m Ω @ -10 V | -3.05 A |

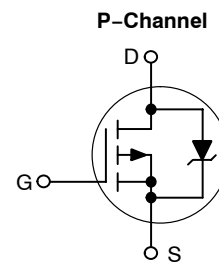

MARKING DIAGRAM* AND PIN ASSIGNMENT



SOIC-8
SUFFIX NB
CASE 751
STYLE 11

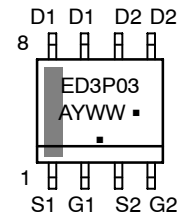

ED3P03= Specific Device Code
A = Assembly Location
Y = Year
WW = Work Week
▪ = Pb-Free Package

(Note: Microdot may be in either location)

*For additional marking information, refer to Application Note AND8002/D.

ORDERING INFORMATION

| Device | Package | Shipping† |
|-------------|------------------|------------------|
| NTMD3P03R2 | SOIC-8 | 2500/Tape & Reel |
| NTMD3P03R2G | SOIC-8 (Pb-Free) | 2500/Tape & Reel |

†For information on tape and reel specifications, including part orientation and tape sizes, please refer to our Tape and Reel Packaging Specifications Brochure, BRD8011/D

NTMD3P03R2

ELECTRICAL CHARACTERISTICS (T_J = 25°C unless otherwise noted) (Note 5)

| Characteristic | Symbol | Min | Typ | Max | Unit |
|----------------|--------|-----|-----|-----|------|
|----------------|--------|-----|-----|-----|------|

OFF CHARACTERISTICS

| | | | | | |
|---|----------------------|-------------|-------------|---------------------|--------------|
| Drain-to-Source Breakdown Voltage (V _{GS} = 0 Vdc, I _D = -250 μAdc) Temperature Coefficient (Positive) | V _{(BR)DSS} | -30 - | - -30 | - - | Vdc mV/°C |
| Zero Gate Voltage Drain Current (V _{DS} = -24 Vdc, V _{GS} = 0 Vdc, T _J = 25°C) (V _{DS} = -24 Vdc, V _{GS} = 0 Vdc, T _J = 125°C) (V _{DS} = -30 Vdc, V _{GS} = 0 Vdc, T _J = 25°C) | I _{DSS} | - - - | - - - | -1.0 -20 -2.0 | μAdc |
| Gate-Body Leakage Current (V _{GS} = -20 Vdc, V _{DS} = 0 Vdc) | I _{GSS} | - | - | -100 | nAdc |
| Gate-Body Leakage Current (V _{GS} = +20 Vdc, V _{DS} = 0 Vdc) | I _{GSS} | - | - | 100 | nAdc |

ON CHARACTERISTICS

| | | | | | |
|--|---------------------|-----------|----------------|----------------|------|
| Gate Threshold Voltage (V _{DS} = V _{GS} , I _D = -250 μAdc) Temperature Coefficient (Negative) | V _{GS(th)} | -1.0 - | -1.7 3.6 | -2.5 - | Vdc |
| Static Drain-to-Source On-State Resistance (V _{GS} = -10 Vdc, I _D = -3.05 Adc) (V _{GS} = -4.5 Vdc, I _D = -1.5 Adc) | R _{DS(on)} | - - | 0.063 0.090 | 0.085 0.125 | Ω |
| Forward Transconductance (V _{DS} = -15 Vdc, I _D = -3.05 Adc) | g _{FS} | - | 5.0 | - | Mhos |

DYNAMIC CHARACTERISTICS

| | | | | | | |
|------------------------------|--|------------------|---|-----|-----|----|
| Input Capacitance | (V _{DS} = -24 Vdc, V _{GS} = 0 Vdc, f = 1.0 MHz) | C _{ISS} | - | 520 | 750 | pF |
| Output Capacitance | | C _{OSS} | - | 170 | 325 | |
| Reverse Transfer Capacitance | | C _{RSS} | - | 70 | 135 | |

SWITCHING CHARACTERISTICS (Notes 6 and 7)

| | | | | | | |
|---------------------|--|---------------------|---|-----|----|----|
| Turn-On Delay Time | (V _{DD} = -24 Vdc, I _D = -3.05 Adc, V _{GS} = -10 Vdc, R _G = 6.0 Ω) | t _{d(on)} | - | 12 | 22 | ns |
| Rise Time | | t _r | - | 16 | 30 | |
| Turn-Off Delay Time | | t _{d(off)} | - | 45 | 80 | |
| Fall Time | | t _f | - | 45 | 80 | |
| Turn-On Delay Time | (V _{DD} = -24 Vdc, I _D = -1.5 Adc, V _{GS} = -4.5 Vdc, R _G = 6.0 Ω) | t _{d(on)} | - | 16 | - | ns |
| Rise Time | | t _r | - | 42 | - | |
| Turn-Off Delay Time | | t _{d(off)} | - | 32 | - | |
| Fall Time | | t _f | - | 35 | - | |
| Total Gate Charge | (V _{DS} = -24 Vdc, V _{GS} = -10 Vdc, I _D = -3.05 Adc) | Q _{tot} | - | 16 | 25 | nC |
| Gate-Source Charge | | Q _{gs} | - | 2.0 | - | |
| Gate-Drain Charge | | Q _{gd} | - | 4.5 | - | |

BODY-DRAIN DIODE RATINGS (Note 6)

| | | | | | | |
|--------------------------------|--|-----------------|--------|----------------|------------|-----|
| Diode Forward On-Voltage | (I _S = -3.05 Adc, V _{GS} = 0 V) (I _S = -3.05 Adc, V _{GS} = 0 V, T _J = 125°C) | V _{SD} | - - | -0.96 -0.78 | -1.25 - | Vdc |
| Reverse Recovery Time | (I _S = -3.05 Adc, V _{GS} = 0 Vdc, dI _S /dt = 100 A/μs) | t _{rr} | - | 34 | - | ns |
| | | t _a | - | 18 | - | |
| | | t _b | - | 16 | - | |
| Reverse Recovery Stored Charge | | Q _{RR} | - | 0.03 | - | μC |

5. Handling precautions to protect against electrostatic discharge is mandatory.
6. Indicates Pulse Test: Pulse Width = 300 μs max, Duty Cycle = 2%.
7. Switching characteristics are independent of operating junction temperature.

NTMD3P03R2

TYPICAL ELECTRICAL CHARACTERISTICS

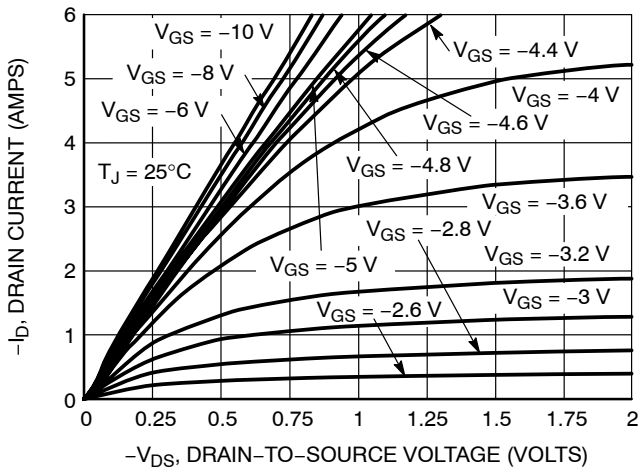

Figure 1. On-Region Characteristics

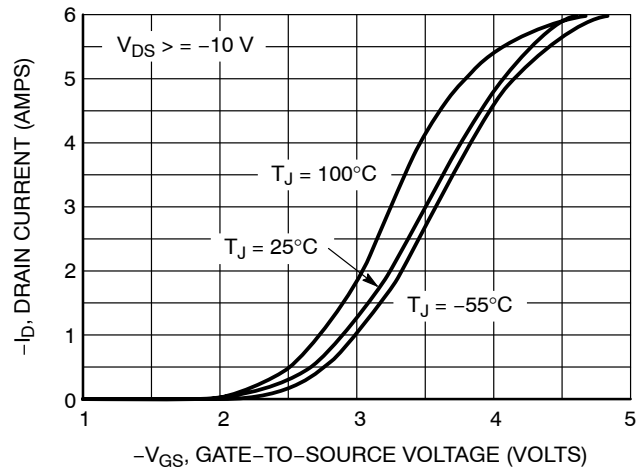

Figure 2. Transfer Characteristics

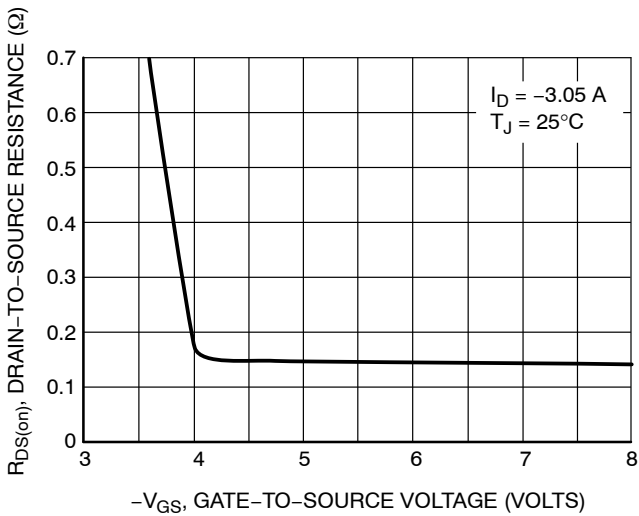

Figure 3. On-Resistance vs. Gate-to-Source Voltage

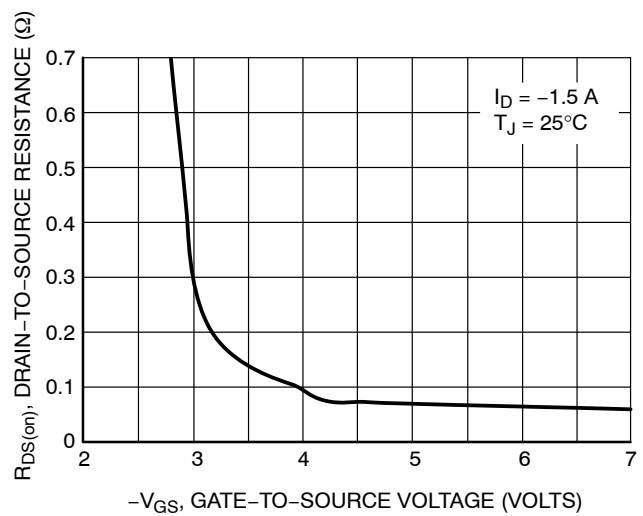

Figure 4. On-Resistance vs. Gate-to-Source Voltage

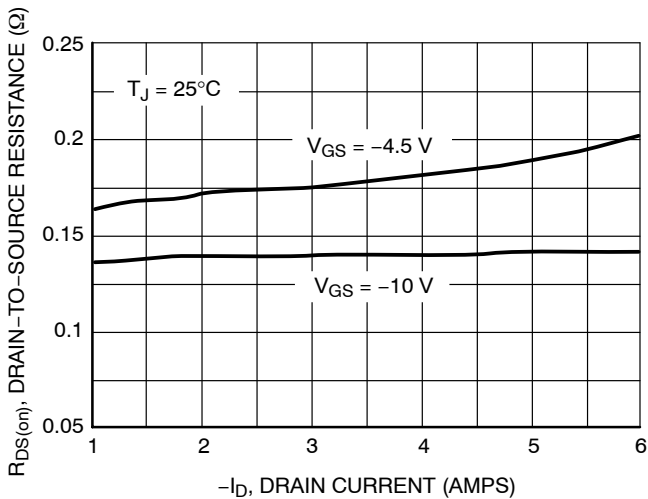

Figure 5. On-Resistance vs. Drain Current and Gate Voltage

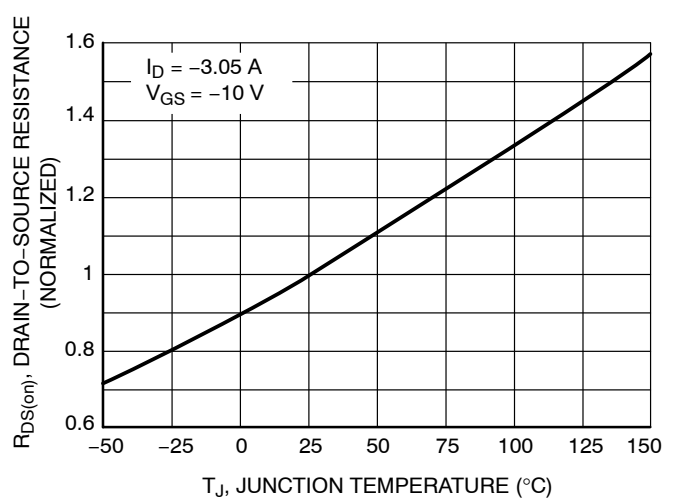

Figure 6. On Resistance Variation with Temperature

NTMD3P03R2

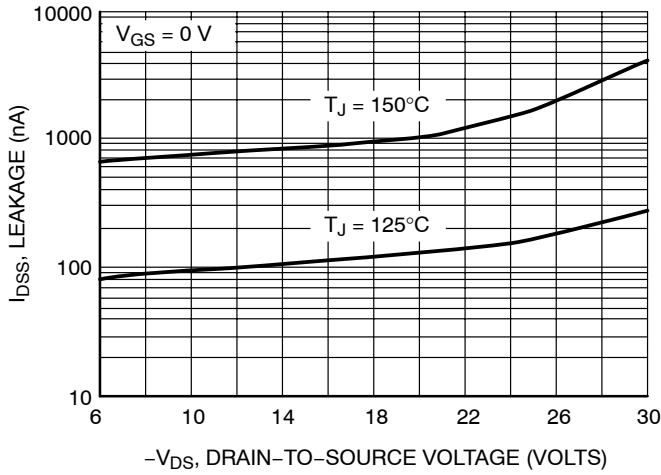

Figure 7. Drain-to-Source Leakage Current vs. Voltage

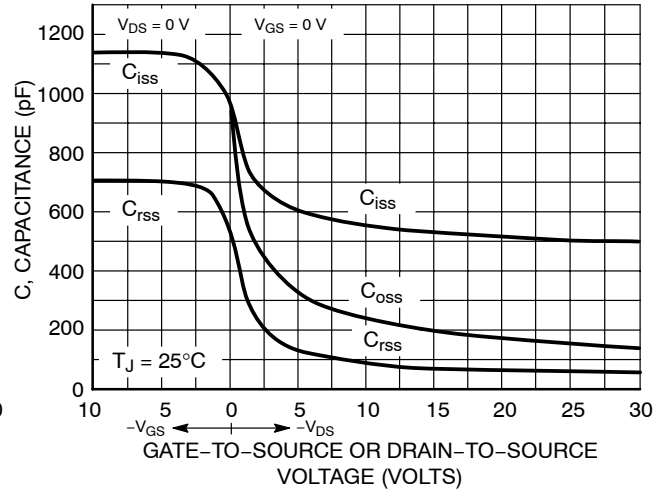

Figure 8. Capacitance Variation

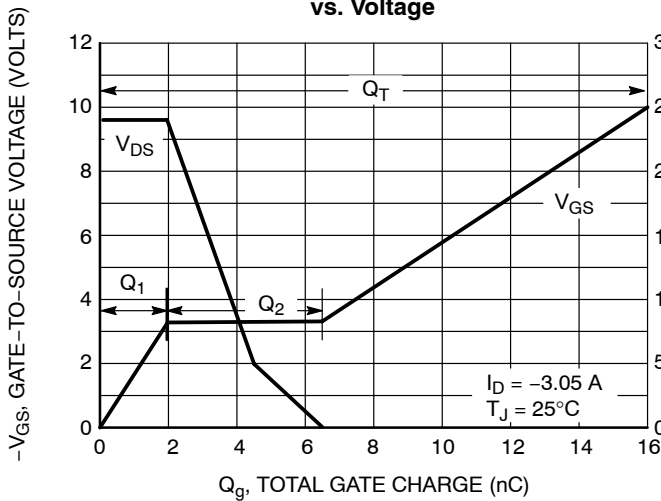

Figure 9. Gate-to-Source and Drain-to-Source Voltage vs. Total Charge

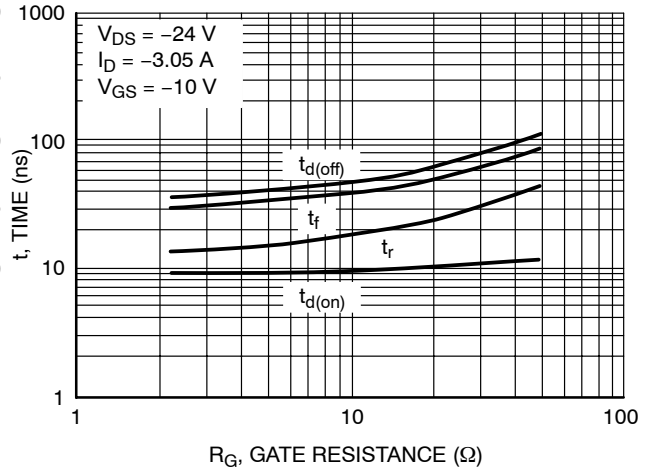

Figure 10. Resistive Switching Time Variation vs. Gate Resistance

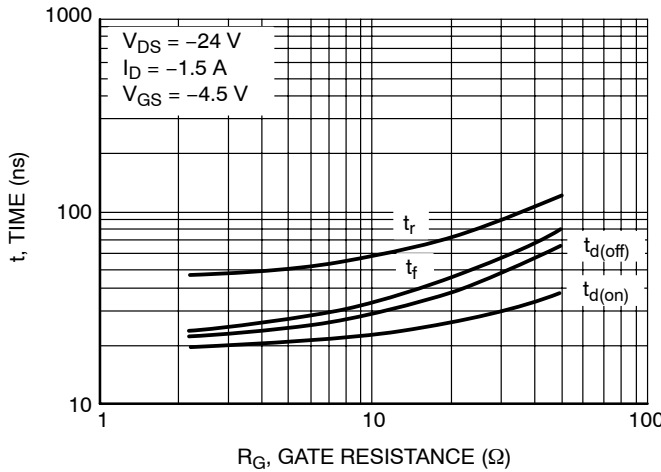

Figure 11. Resistive Switching Time Variation vs. Gate Resistance

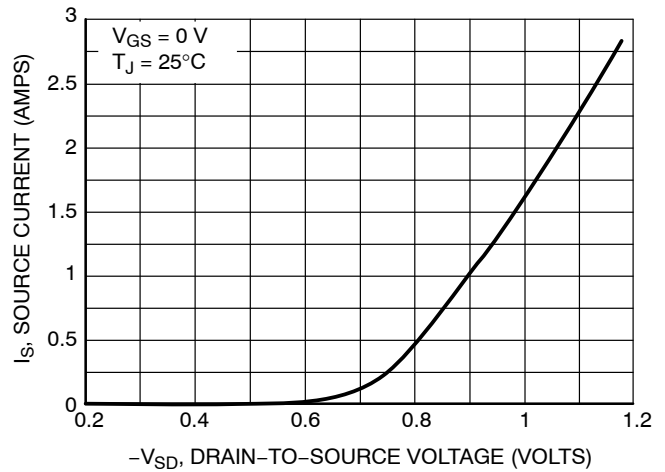

Figure 12. Diode Forward Voltage vs. Current

NTMD3P03R2

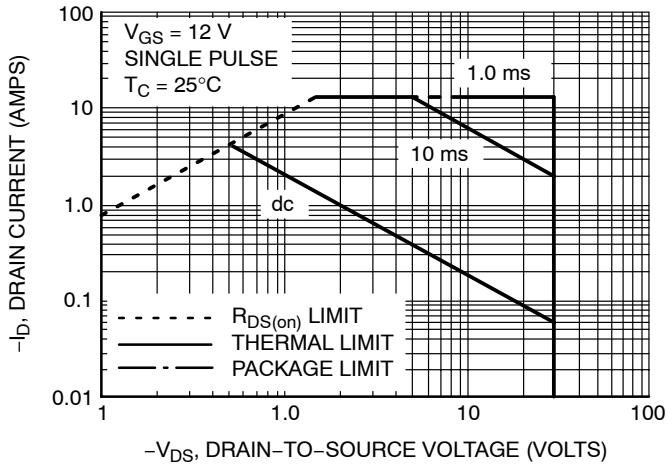

Figure 13. Maximum Rated Forward Biased Safe Operating Area

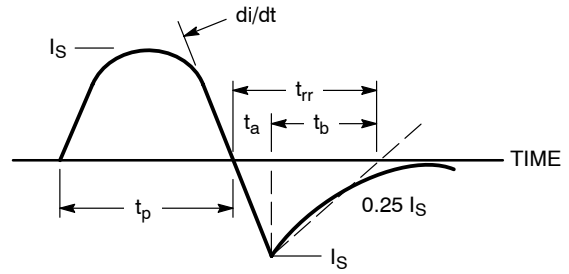

Figure 14. Diode Reverse Recovery Waveform

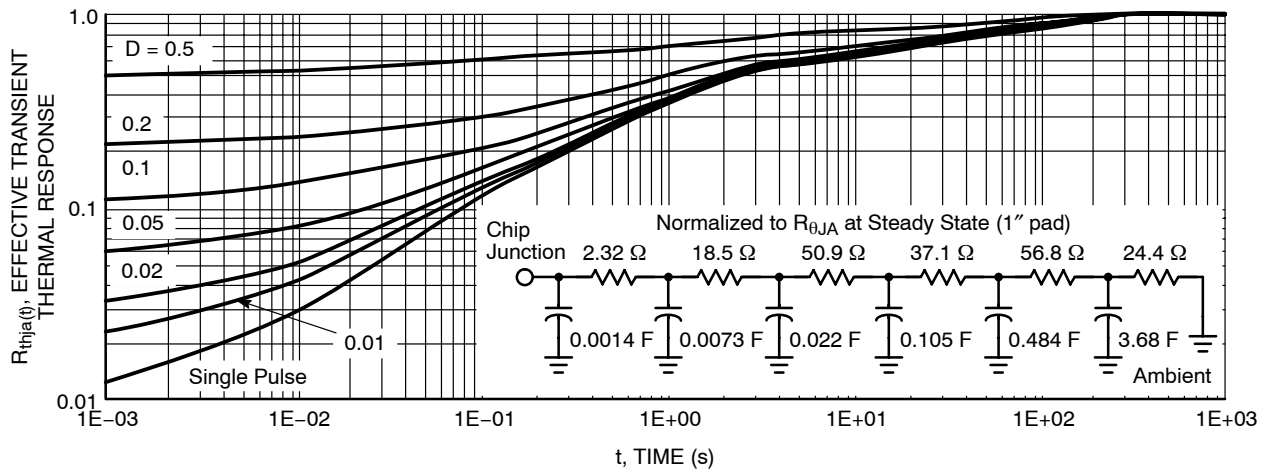
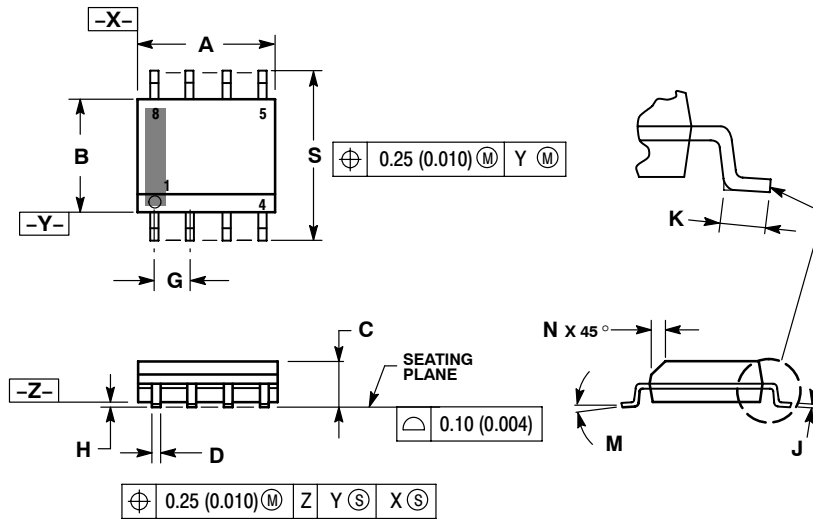

Figure 15. FET Thermal Response

NTMD3P03R2

PACKAGE DIMENSIONS

SOIC-8 NB
CASE 751-07
ISSUE AG



NOTES:

1. DIMENSIONING AND TOLERANCING PER ANSI Y14.5M, 1982.
2. CONTROLLING DIMENSION: MILLIMETER.
3. DIMENSION A AND B DO NOT INCLUDE MOLD PROTRUSION.
4. MAXIMUM MOLD PROTRUSION 0.15 (0.006) PER SIDE.
5. DIMENSION D DOES NOT INCLUDE DAMBAR PROTRUSION. ALLOWABLE DAMBAR PROTRUSION SHALL BE 0.127 (0.005) TOTAL IN EXCESS OF THE D DIMENSION AT MAXIMUM MATERIAL CONDITION.
6. 751-01 THRU 751-06 ARE OBSOLETE. NEW STANDARD IS 751-07.

| DIM | MILLIMETERS | | INCHES | |
|-----|-------------|------|-----------|-------|
| | MIN | MAX | MIN | MAX |
| A | 4.80 | 5.00 | 0.189 | 0.197 |
| B | 3.80 | 4.00 | 0.150 | 0.157 |
| C | 1.35 | 1.75 | 0.053 | 0.069 |
| D | 0.33 | 0.51 | 0.013 | 0.020 |
| G | 1.27 BSC | | 0.050 BSC | |
| H | 0.10 | 0.25 | 0.004 | 0.010 |
| J | 0.19 | 0.25 | 0.007 | 0.010 |
| K | 0.40 | 1.27 | 0.016 | 0.050 |
| M | 0° | 8° | 0° | 8° |
| N | 0.25 | 0.50 | 0.010 | 0.020 |
| S | 5.80 | 6.20 | 0.228 | 0.244 |

SOLDERING FOOTPRINT*

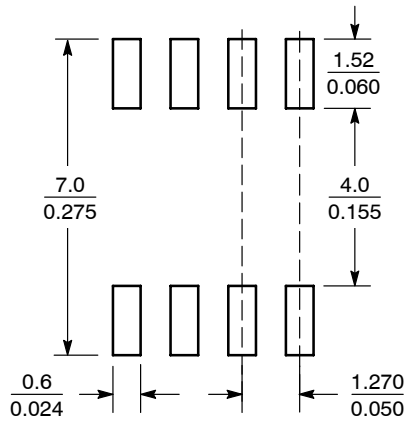

SCALE 6:1 $\left(\frac{\text{mm}}{\text{inches}}\right)$

*For additional information on our Pb-Free strategy and soldering details, please download the ON Semiconductor Soldering and Mounting Techniques Reference Manual, SOLDERRM/D.

STYLE 11:

1. SOURCE 1
2. GATE 1
3. SOURCE 2
4. GATE 2
5. DRAIN 2
6. DRAIN 2
7. DRAIN 1
8. DRAIN 1

ON Semiconductor and are registered trademarks of Semiconductor Components Industries, LLC (SCILLC). SCILLC reserves the right to make changes without further notice to any products herein. SCILLC makes no warranty, representation or guarantee regarding the suitability of its products for any particular purpose, nor does SCILLC assume any liability arising out of the application or use of any product or circuit, and specifically disclaims any and all liability, including without limitation special, consequential or incidental damages. "Typical" parameters which may be provided in SCILLC data sheets and/or specifications can and do vary in different applications and actual performance may vary over time. All operating parameters, including "Typicals" must be validated for each customer application by customer's technical experts. SCILLC does not convey any license under its patent rights nor the rights of others. SCILLC products are not designed, intended, or authorized for use as components in systems intended for surgical implant into the body, or other applications intended to support or sustain life, or for any other application in which the failure of the SCILLC product could create a situation where personal injury or death may occur. Should Buyer purchase or use SCILLC products for any such unintended or unauthorized application, Buyer shall indemnify and hold SCILLC and its officers, employees, subsidiaries, affiliates, and distributors harmless against all claims, costs, damages, and expenses, and reasonable attorney fees arising out of, directly or indirectly, any claim of personal injury or death associated with such unintended or unauthorized use, even if such claim alleges that SCILLC was negligent regarding the design or manufacture of the part. SCILLC is an Equal Opportunity/Affirmative Action Employer. This literature is subject to all applicable copyright laws and is not for resale in any manner.

PUBLICATION ORDERING INFORMATION

LITERATURE FULFILLMENT:
Literature Distribution Center for ON Semiconductor
P.O. Box 61312, Phoenix, Arizona 85082-1312 USA
Phone: 480-829-7710 or 800-344-3860 Toll Free USA/Canada
Fax: 480-829-7709 or 800-344-3867 Toll Free USA/Canada
Email: orderlit@onsemi.com

N. American Technical Support: 800-282-9855 Toll Free USA/Canada

Japan: ON Semiconductor, Japan Customer Focus Center
2-9-1 Kamimeguro, Meguro-ku, Tokyo, Japan 153-0051
Phone: 81-3-5773-3850

ON Semiconductor Website: <http://onsemi.com>

Order Literature: <http://www.onsemi.com/litorder>

For additional information, please contact your local Sales Representative.