

SPNovaLEDTM

Featuring a staggering brilliance and significant flux output, the SPNovaLEDTM showcases the latest technological advent in this range. With its extremely high level of brightness and the ultra low high profile, which is only 1.5 mm are highly suitable for both conventional lighting and specialized application such as automotive signal lights, traffic lights, channel lights, tube lights and garden lights among others.

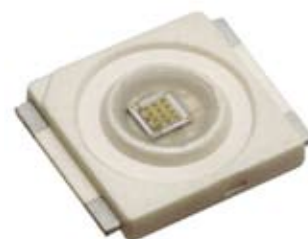

Features:

- > Super high brightness surface mount LED.
- > High flux output.
- > 120° viewing angle.
- > Compact package outline (LxWxH) of 6.0 x 6.0 x 1.5mm.
- > Ultra low height profile - 1.5 mm.
- > Designed for high current drive; typically 350 mA.
- > Low thermal resistance; $R_{th(jc)} = 20 \text{ K/W}$.
- > Qualified according to JEDEC moisture sensitivity Level 2.
- > Compatible to both IR reflow soldering.
- > Environmental friendly; RoHS compliance.
- > SP NovaLED are Class 1M LED products. Do not view directly with optical instrument.



Applications:

- > Automotive: exterior applications, eg: Center High Mounted Stop Light (CHMSL), Rear Combination Lights (RCLs), Signal lighting, Fog-lamp, etc.
- > Communication: indicator and backlight in mobilephone.
- > Industry: white goods (eg: Oven, microwave, etc.).
- > Lighting: garden light, architecture lighting, general lighting. etc

Part Ordering Number	Chip Technology / Color	Viewing Angle°	Luminous Intensity @ IF = 350mA (mcd)
NPT-USS-ADE-1	InGaN	120	14,000.0 - 22,400.0
• NPT-USS-AD	True Green, 525		14,000.0 - 18,000.0
• NPT-USS-AE			18,000.0 - 22,400.0

NOTE

- Luminous intensity is measured with an accuracy of ± 11%.
- Wavelength binning is carried for all units as per the wavelength-binning table. Only one wavelength group is allowed for each reel.

Wavelength Grouping

Color	Group	Wavelength distribution (nm)
NPT; True Green	Full	525 - 535
	A	525 - 530
	B	530 - 535

Dominant wavelength is measured with an accuracy of ± 1 nm.

Electrical Characteristics at Ta=25°C

Part Number	Typ. (V)	Vf @ If = 350mA	Max. (V)
NPT-USS	3.6		4.0

Forward voltages are measure using a current pulse of 1 ms and with an accuracy of ± 0.1V.

Optical Characteristics at Ta=25°C

Part Number	Intensity @ If=350mA (mcd)		
	Min.	Typ.	Max.
NPT-USS-ADE	14,000	16,000	22,400

Correlation Between Luminous Intensity And Luminous Flux

IV Bins	Luminous Intensity (mcd)		Luminous Flux (lm)	
	Min.	Max.	Min.	Max.
AD	14,000	18,000	37.8	48.6
AE	18,000	22,400	48.6	60.5

Note: Data provided above is based on approximation

Material

Material	
Lead-frame	Cu Alloy With Ag Plating
Package	High Temperature Resistant Plastic, PPA
Encapsulant	Silicone Resin
Soldering Leads	Sn-Sn Plating

Absolute Maximum Ratings

	Maximum Value	Unit
DC forward current	350	mA
Pulse current	1000	mA
Reverse Voltage	Not designed for reverse bias	V
ESD Threshold (HBM)	2000	V
LED junction temperature	120	°C
Operating temperature	-40 ... +100	°C
Storage temperature	-40 ... +100	°C

Wavelength Vs Forward Current

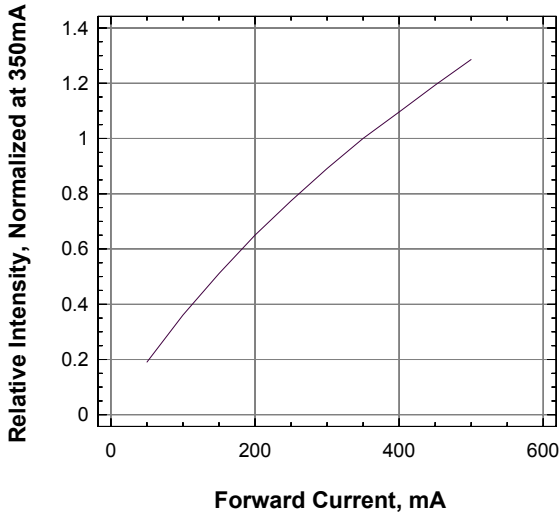

Relative Flux Vs Forward Current

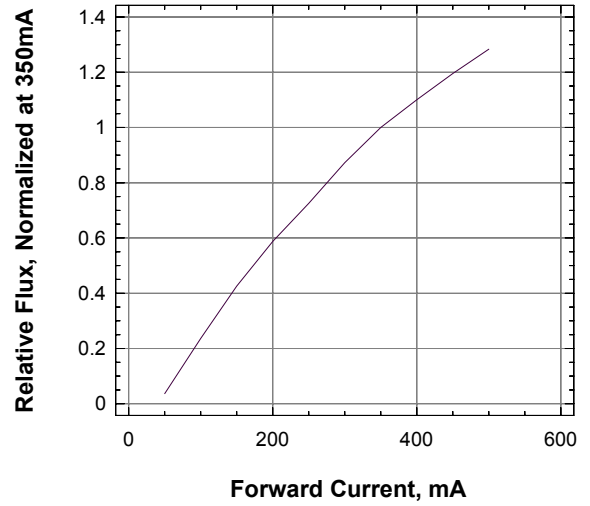

Forward Current Vs Forward Voltage

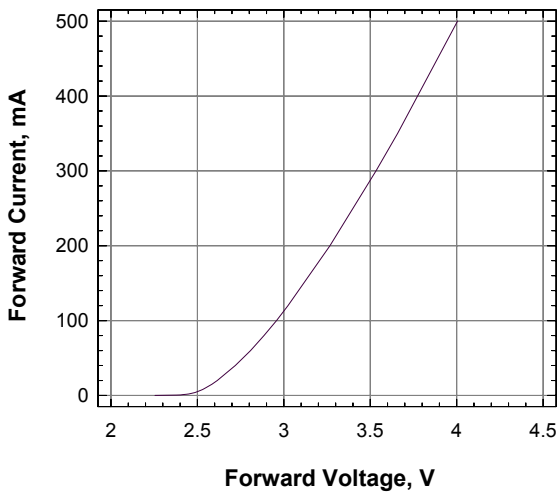

Forward Current Vs Ambient Temperature (Rja=40KW)

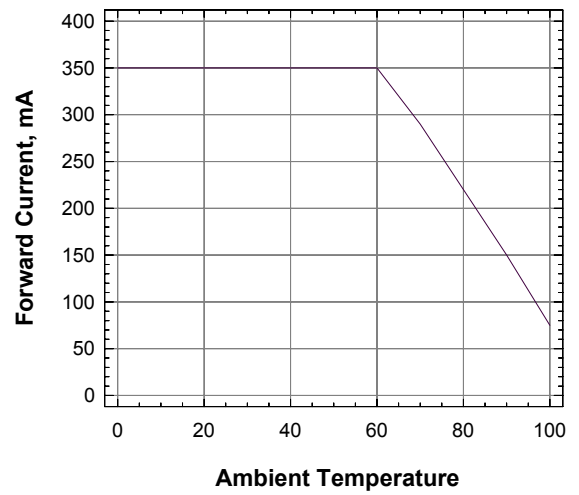

Forward Current Vs Solder Point Temperature

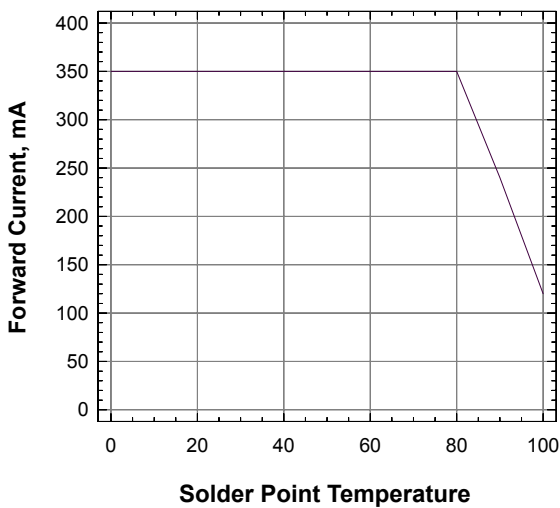

Wavelength Vs Forward Current

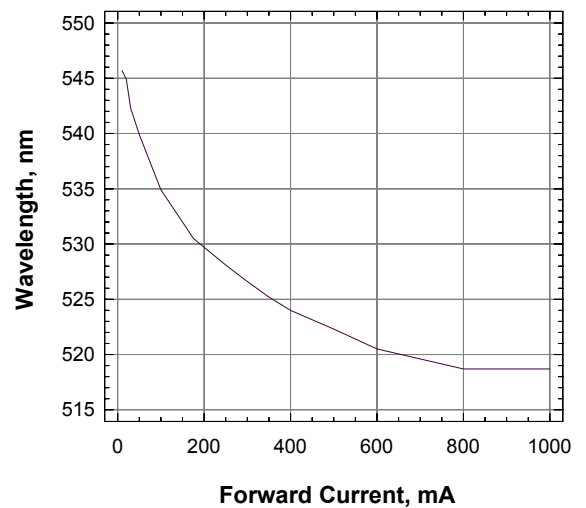

Radiation Pattern

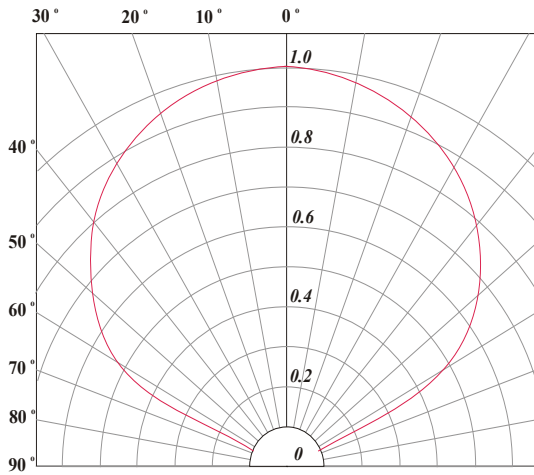

Maximum Permissible Pulse Current, Ta=25 °C

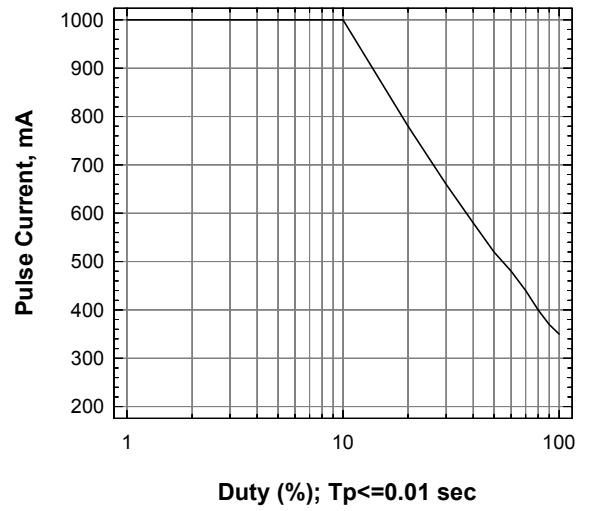

SPNovaLED™ • InGaN True Green : 1 Watt Package Outlines

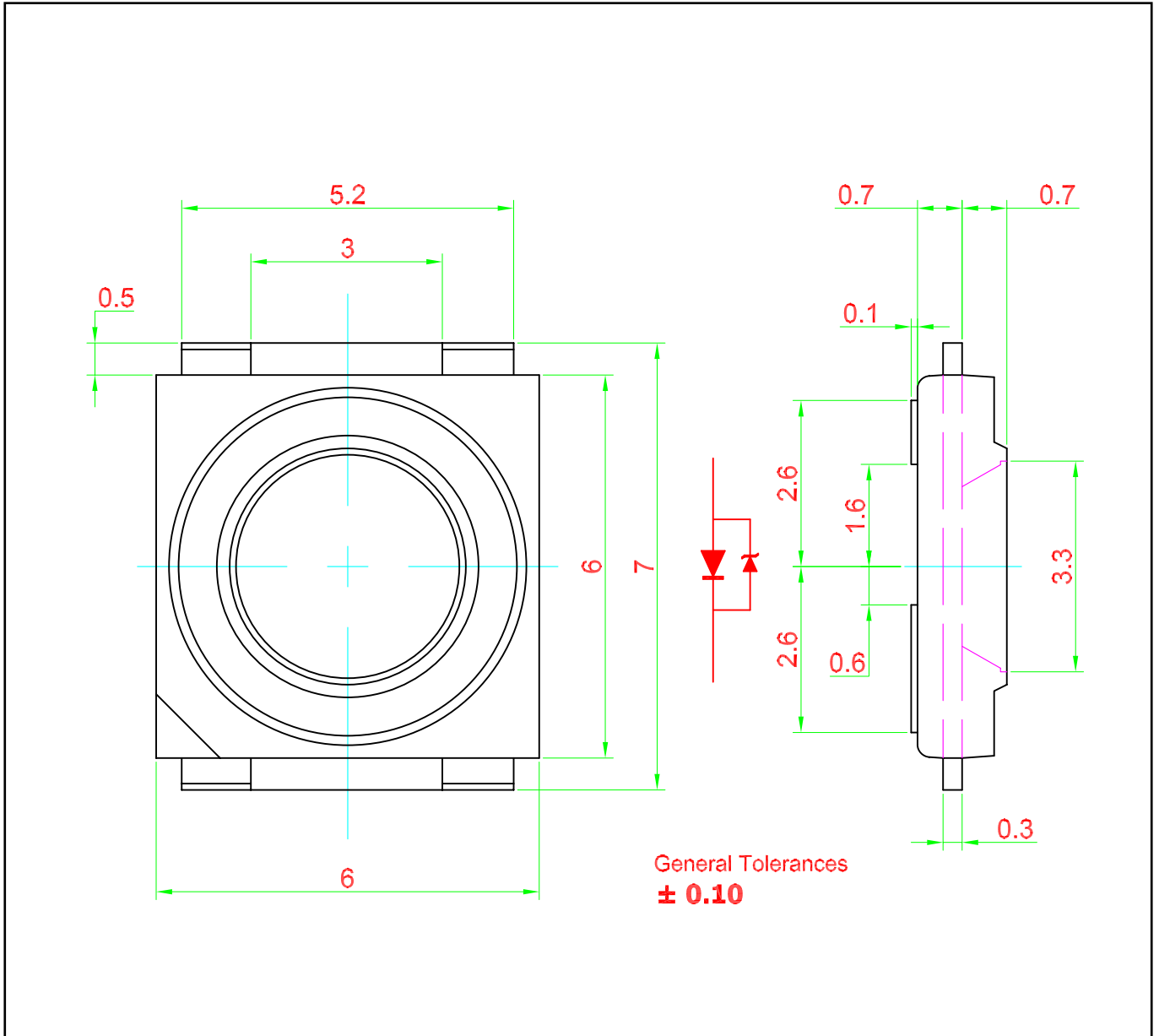

Recommended Solder Pad

Note: Unit to unit pitching must not be less than 25 mm. Metal core circuit board (MCPCB) is highly recommended for high density applications. Please consult sales and marketing for additional information.

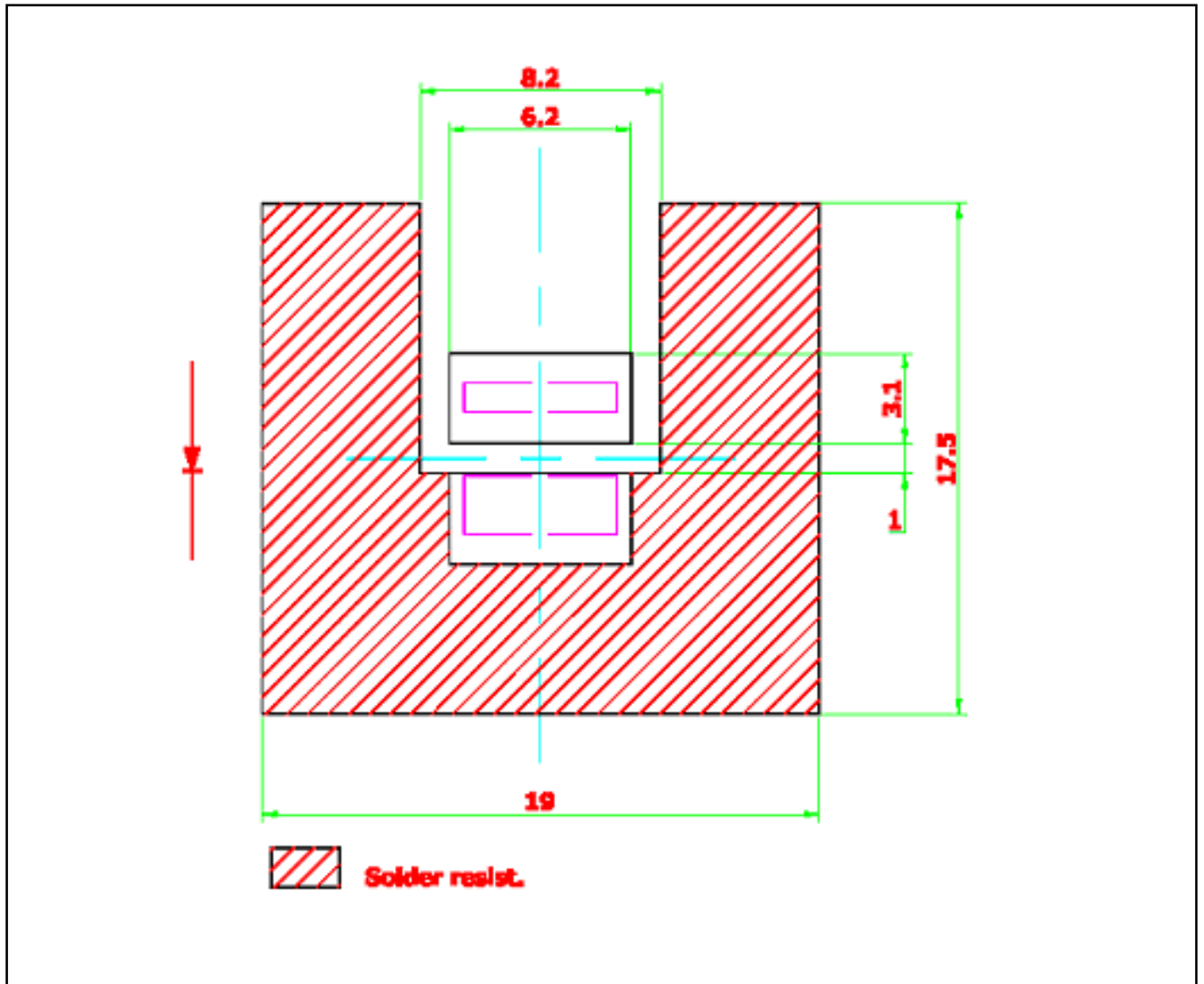

Taping and orientation

- Reels come in quantity of 2000 units.
- Reel diameter is 330 mm.

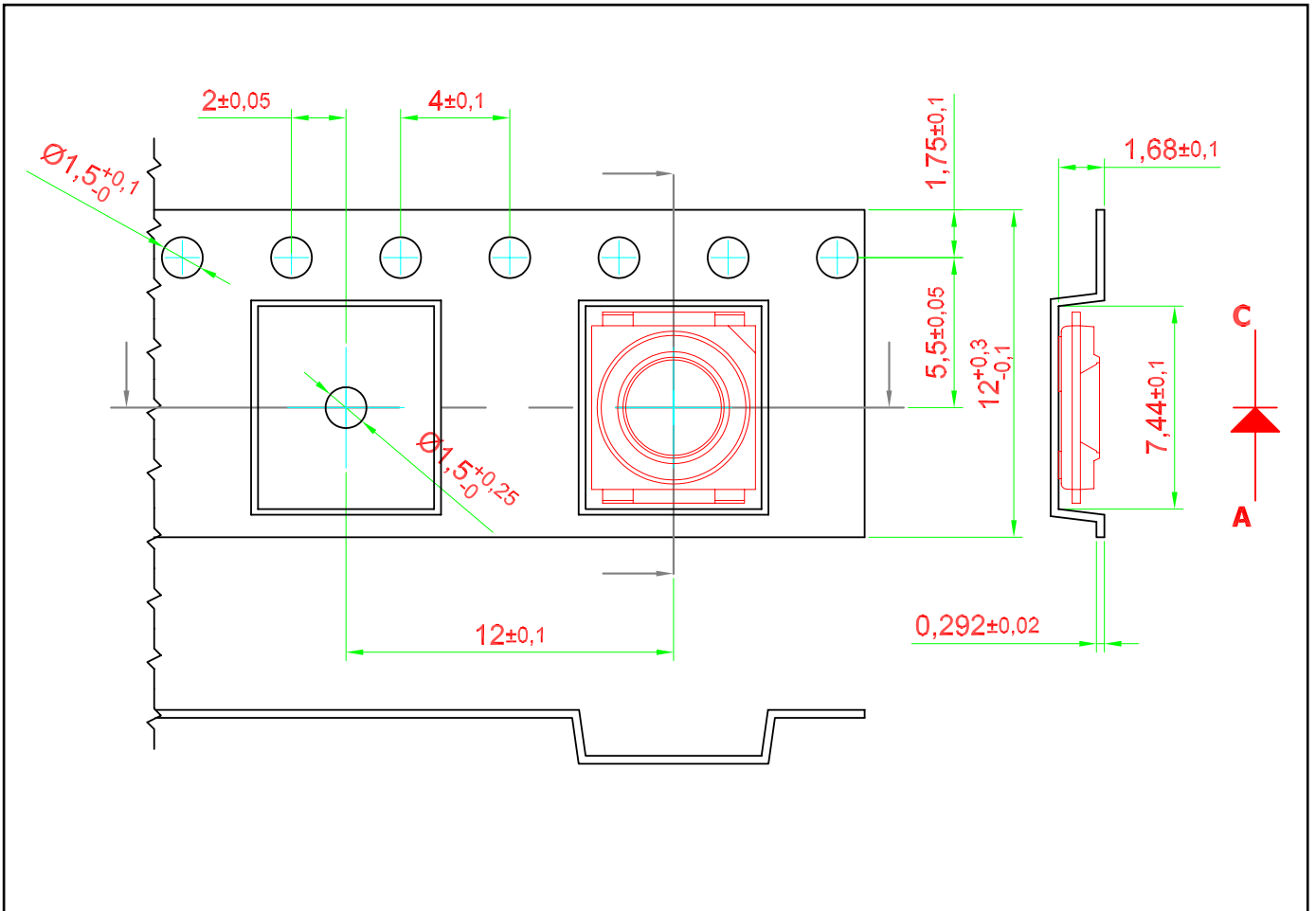

Packaging Specification

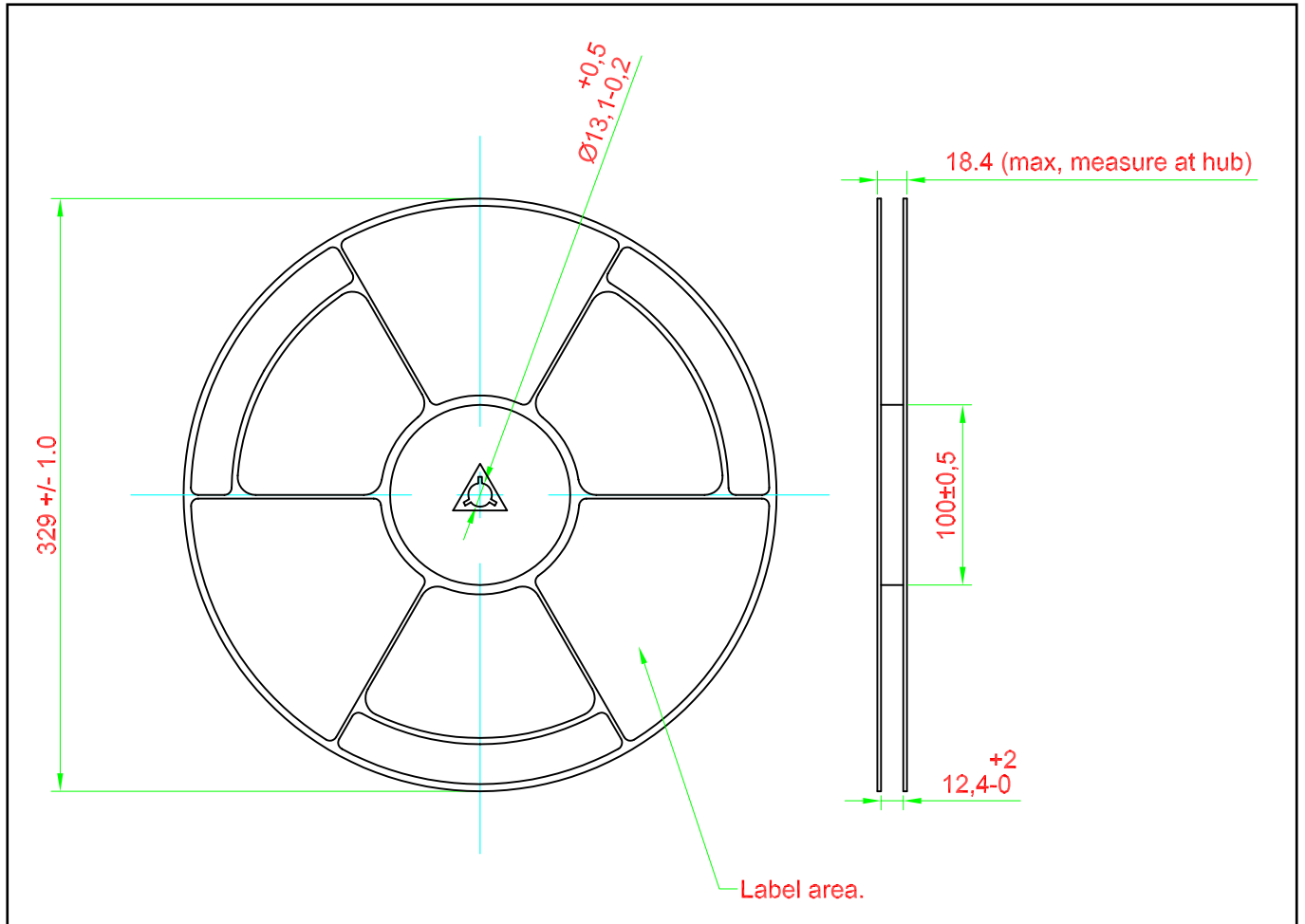

Packaging Specification

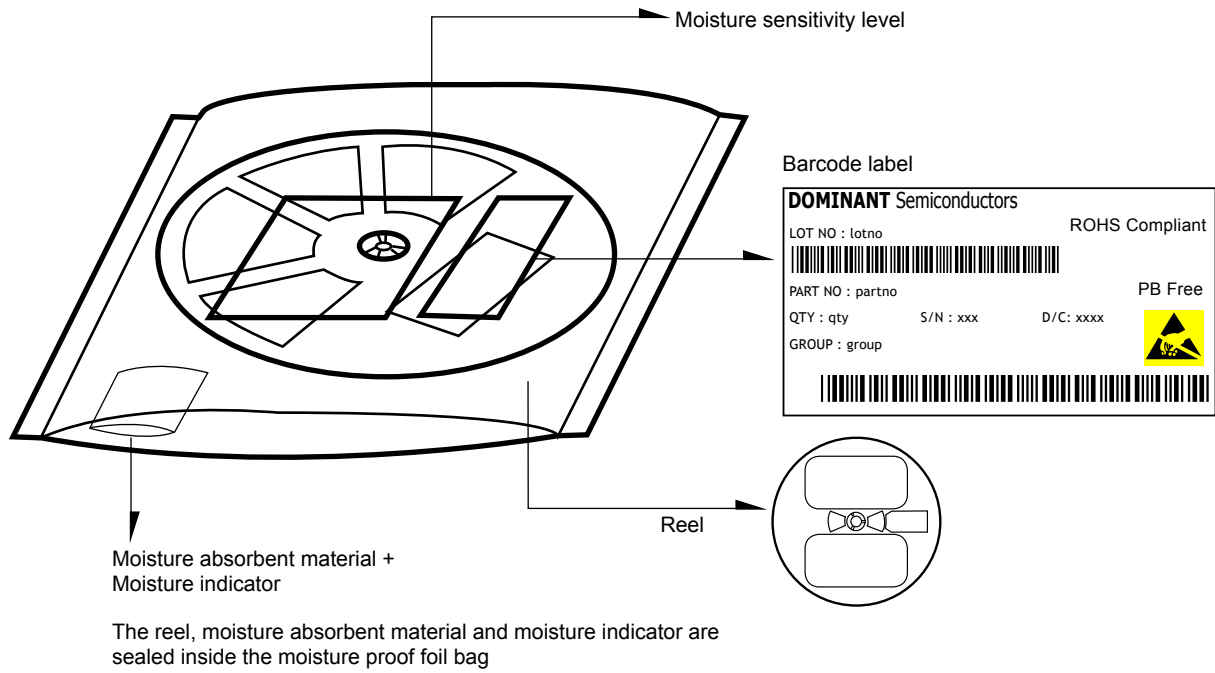

	Average 1pc SPNovaLED	1 completed bag (2000pcs)
Weight (gram)	0.188	800 ± 10

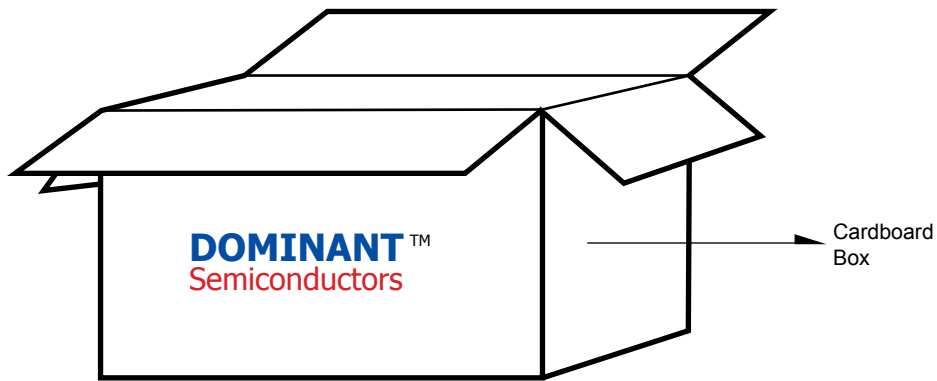

For SPNovaLED™

Cardboard Box Size	Dimensions (mm)	Empty Box Weight (kg)	Reel / Box	Quantity / Box (pcs)
Large	416 x 516 x 476	1.74	20 reels MAX	40,000 MAX

Recommended Sn-Pb IR-Reflow Soldering Profile

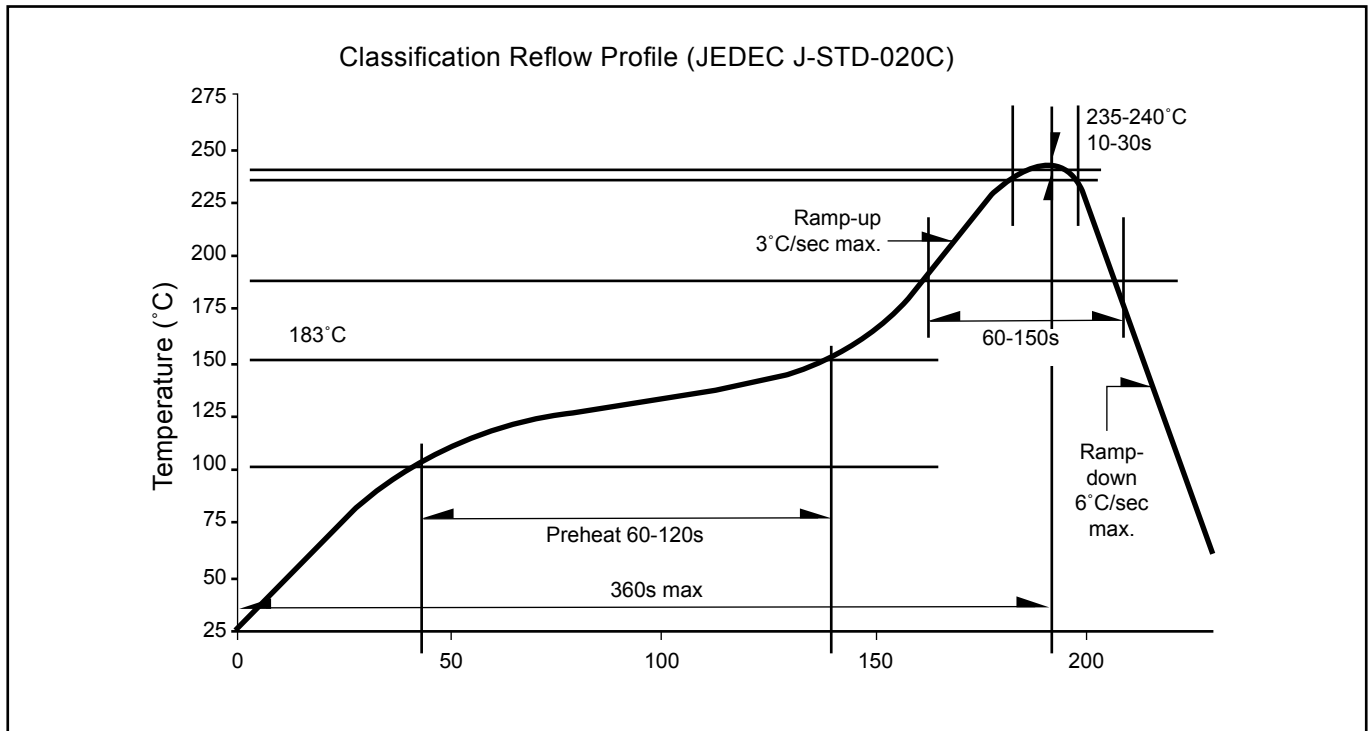

Recommended Pb-free Soldering Profile

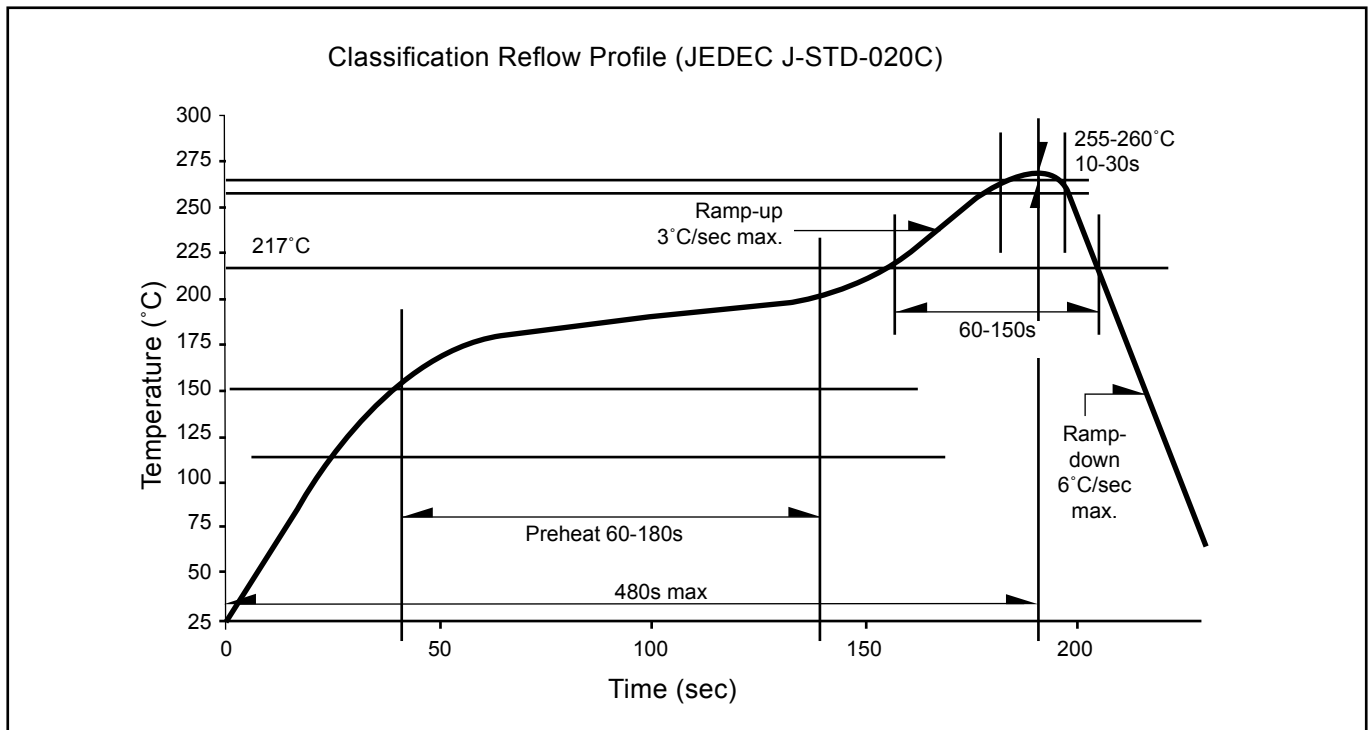

Revision History

Page	Subjects	Date of Modification
-	Initial Release	20 Jun 2006
5	Add Maximum Permissible Pulse Current Graph	24 Aug 2006

NOTE

All the information contained in this document is considered to be reliable at the time of publishing. However, DOMINANT Semiconductors does not assume any liability arising out of the application or use of any product described herein.

DOMINANT Semiconductors reserves the right to make changes at any time without prior notice to any products in order to improve reliability, function or design.

DOMINANT Semiconductors products are not authorized for use as critical components in life support devices or systems without the express written approval from the Managing Director of DOMINANT Semiconductors.

About Us

DOMINANT Semiconductors is a dynamic Malaysian Corporation that is among the world's leading SMT LED Manufacturers. An excellence – driven organization, it offers a comprehensive product range for diverse industries and applications. Featuring an internationally certified quality assurance acclaim, DOMINANT's extra bright LEDs are perfectly suited for various lighting applications in the automotive, consumer and communications as well as industrial sectors. With extensive industry experience and relentless pursuit of innovation, DOMINANT's state-of-art manufacturing, research and testing capabilities have become a trusted and reliable brand across the globe. More information about DOMINANT Semiconductors can be found on the Internet at <http://www.dominant-semi.com>.

Please contact us for more information:

Head Quarter

DOMINANT Semiconductors Sdn. Bhd.
Lot 6, Batu Berendam, FTZ Phase III, 75350 Melaka, Malaysia
Tel: (606) 283 3566 Fax: (606) 283 0566
E-mail: sales@dominant-semi.com

DOMINANT China Sales Office

DOMINANT Semiconductors (Shenzhen) Co. Ltd.
24B.C Newbaohui Building, No. 1007 West Nanhai Blvd., Nanshan, Shenzhen, China P.C. 518054
Tel: +86 (755) 86031785 / +86 (755) 86031786 Fax: +86 (755) 86031789
E-mail: sales_china@dominant-semi.com

DOMINANT Korea Sales Office

DOMINANT Semiconductors Korea Inc.
902 Sunil Technopia, 440 Sangdaewon-dong, Jungwon-gu, Sungnam-si, Kyunggi-do, Korea 462726
Tel: 82-31-777-3978 Fax: 82-31-777-3976
E-mail: sales_korea@dominant-semi.com

