



## 3D SURROUND AUDIO PROCESSOR FOR HEADPHONE

### ■ GENERAL DESCRIPTION

The **NJM2704** is a high quality 3D surround audio processor designed for headphone applications.

It includes mode control switches for surround function and standby function and realizes low consumption power design by standby function.

In addition to SSOP14, ultra small and thin package FFP12 (Flip-chip Fine Package) is applied. It is suitable for portable telephone, PDA and any portable audio applications.

### ■ PACKAGE OUTLINE

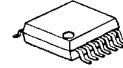

**NJM2704V**



**NJM2704PB1**

### ■ FEATURES

- Operating Voltage 1.8 to 6V
- Low Operating Current 0.45mA typ. (at Active mode)  
0.1μA typ. (at Standby mode)
- Low Output Noise 10μV typ. (at Surround mode, VR: max.)
- Variable Surround Effect by external resistor
- Internal Mode Control Switch
- Bipolar Technology
- Package Outline SSOP14, FFP12

### ■ PIN CONFIGURATION

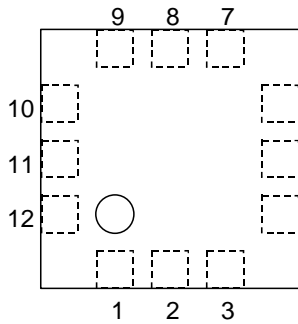

(FFP12)

1. VREF
2. MODE SW
3. RIN
4. LIN
5. STANDBY SW
6. LOUT
7. ROUT
8. NFL
9. NFR
10. V+
11. DNC
12. GND

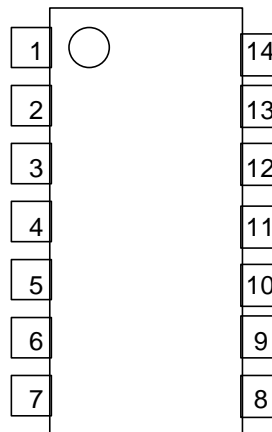

(SSOP14)

1. STANDBY SW
2. LIN
3. RIN
4. MODE SW
5. VREF
6. GND
7. NC
8. DNC
9. V+
10. NFR
11. NFL
12. ROUT
13. LOUT
14. NC

# NJM2704

## ■ BLOCK DIAGRAM

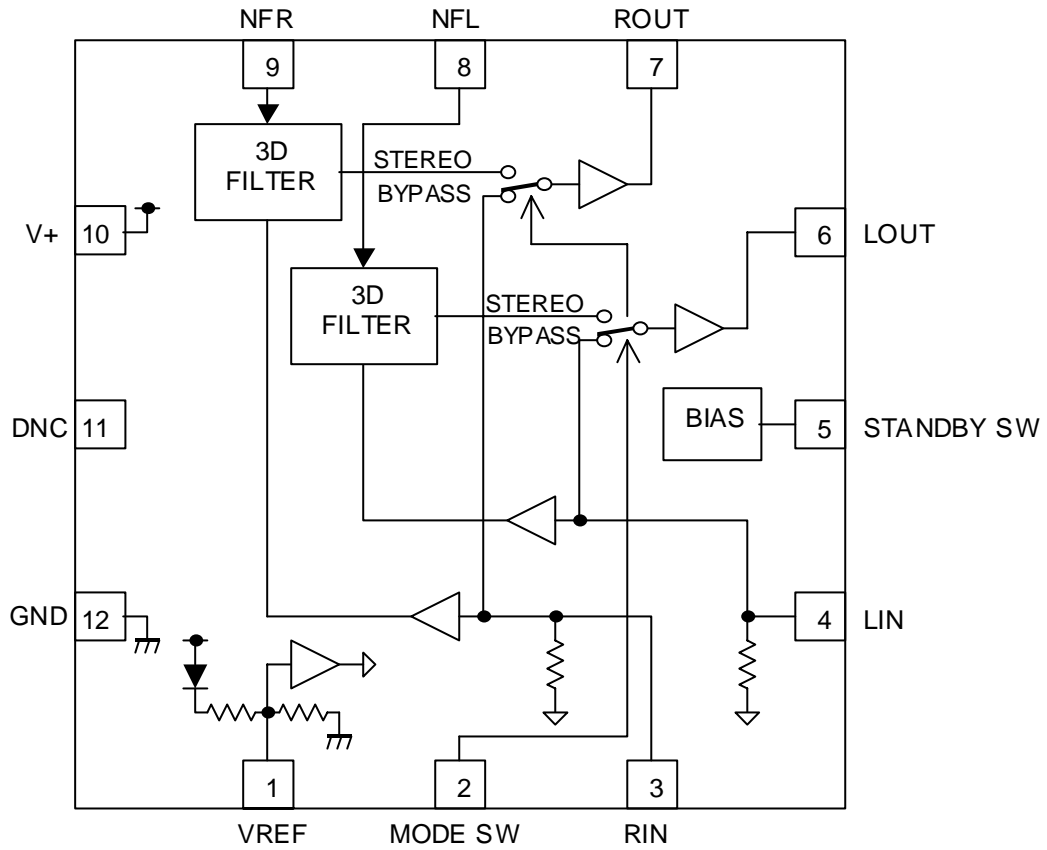

## ■ABSOLUTE MAXIMUM RATING (Ta=25°C)

PARAMETER	SYMBOL	RATINGS	UNIT
Supply Voltage	V <sup>+</sup>	7	V
Power Dissipation	P <sub>D</sub>	320	mW
Operating Temperature Range	T <sub>opr</sub>	-20 to +75	°C
Storage Temperature Range	T <sub>stg</sub>	-40 to +125	°C

## ■OPERATING VOLTAGE

PARAMETER	SYMBOL	TEST CONDITION	MIN.	TYP.	MAX.	UNIT
Operating Voltage	V <sup>+</sup>	-	1.8	3.0	6.0	V

## ■ELECTRICAL CHARACTERISTICS (V<sup>+</sup>=3V, Ta=25°C unless otherwise specified)

PARAMETER	SYMBOL	TEST CONDITION					MIN.	TYP.	MAX.	UNIT	
		INPUT		OUTPUT	MODE	VR					
		L	R								
Operating Current	I <sub>cc</sub>	No Signal	0	0	-	Active	-	-	450	700	μA
			0	0	-	Standby	-	-	0.1	1.0	
Reference Voltage	V <sub>ref</sub>	No Signal	0	0	-	-	-	1.0	1.15	1.3	V

## ●AC CHARACTERISTICS

(V<sup>+</sup>=3V, Ta=25°C, V<sub>IN</sub>=-20dBV(100mVrms), f=1kHz, R<sub>L</sub>=10kΩ, unless otherwise specified)

PARAMETER	SYMBOL	TEST CONDITION					MIN.	TYP.	MAX.	UNIT	
		INPUT		OUTPUT	MODE	VR					
		L	R								
Maximum Input Voltage	V <sub>IM</sub>	f=1kHz T.H.D.=1%	V <sub>IN</sub> 0	0 V <sub>IN</sub>	L R	Bypass	-	-	-2.0 (790)	-	dBV (mVrms)
		f=100Hz T.H.D.=1%	V <sub>IN</sub> 0	0 V <sub>IN</sub>	L R	Surround	MAX	-	-16.0 (160)	-	
		V <sup>+</sup> =1.8V f=1kHz T.H.D.=1%	V <sub>IN</sub> 0	0 V <sub>IN</sub>	L R	Bypass	-	-10.5 (300)	-8.5 (380)	-	
		V <sup>+</sup> =1.8V f=100Hz T.H.D.=1%	V <sub>IN</sub> 0	0 V <sub>IN</sub>	L R	Surround	MAX	-24.5 (60)	-22.5 (75)	-	
Output Noise	V <sub>NO</sub>	R <sub>g</sub> =0Ω A-Weighted	0	0	L R	Bypass	-	-	-112 (2.5)	-106 (5.0)	dBV (μVrms)
		R <sub>g</sub> =0Ω A-Weighted	0	0	L R	Surround	MAX	-	-100 (10)	-94 (20)	
Total Harmonic Distortion	T.H.D.	f=1kHz	V <sub>IN</sub> 0	0 V <sub>IN</sub>	L R	Bypass	-	-	0.02	0.05	%
		f=1kHz	V <sub>IN</sub> 0	0 V <sub>IN</sub>	L R	Surround	MAX	-	0.1	0.5	

# NJM2704

## ●AC CHARACTERISTICS

( $V_+ = 3V$ ,  $T_a = 25^\circ C$ ,  $V_{IN} = -20dBV(100mVrms)$ ,  $f = 1kHz$ ,  $R_L = 10k\Omega$ , unless otherwise specified)

PARAMETER	SYMBOL	TEST CONDITION						MIN.	TYP.	MAX.	UNIT
		INPUT		OUTPUT	MODE	VR					
		L	R								
Bypass Gain	$G_{VBYP}$	$f = 1kHz$	$V_{IN}$ 0	0 $V_{IN}$	L R	Bypass	-	-1.0	0.0	1.0	dB
Surround Gain	$G_{VSUR}$	$f = 100Hz$	$V_{IN}$ 0	0 $V_{IN}$	L R	Surround	MAX	12.5	14.5	16.5	dB
		$f = 100Hz$	0 $V_{IN}$	$V_{IN}$ 0	L R	Surround	MAX	10.5	12.5	14.5	
		$f = 100Hz$	$V_{IN}$ 0	0 $V_{IN}$	L R	Surround	MIN	0.5	2.5	4.5	

## ●CONTROL CHARACTERISTICS ( $V_+ = 3V$ , $T_a = 25^\circ C$ unless otherwise specified)

PARAMETER	SYMBOL	TEST CONDITION						MIN.	TYP.	MAX.	UNIT
		INPUT		OUTPUT	MODE	VR					
		L	R								
Mode Select Control Voltage	$V_{MODE}$	$V_{IN} =$ High Level	-	-	-	-	-	1.2	-	$V_+$	V
		$V_{IN} =$ Low Level	-	-	-	-	-	0.0	-	0.3	

## ■SWITCH FUNCTION

### MODE SW

MODE	Terminal Status	NOTES
Bypass	L, open	Input Through
Surround	H	Surround Mode (Stereo Input)

### STANDBY SW

MODE	Terminal Status	NOTES
Standby	L, open	IC is non-active
Active	H	IC is active

## ■ TERMINAL DESCRIPTION

PIN No.		SYMBOL	FUNCTION	EQUIVALENT CIRCUIT	Voltage
FFP12	SSOP14				
1	5	VREF	Reference voltage		1.15V
2	4	MODE SW	Mode control switch		0V
3 4	3 2	RIN LIN	Rch Input Lch Input		1.15V
5	1	STANDBY SW	Standby switch		0V

# NJM2704

PIN No.		SYMBOL	FUNCTION	EQUIVALENT CIRCUIT	Voltage
FFP12	SSOP14				
6 7	13 12	LOUT ROUT	Lch Output Rch Output		1.15V
8 9	11 10	NFL NFR	Filter terminal Filter terminal		1.15V
10	9	V+	Power Supply	_____	V+
-	7 14	NC	No Connect	_____	-
11	8	DNC	Do Not Connect	_____	-

## APPLICATION CIRCUIT

FFP12

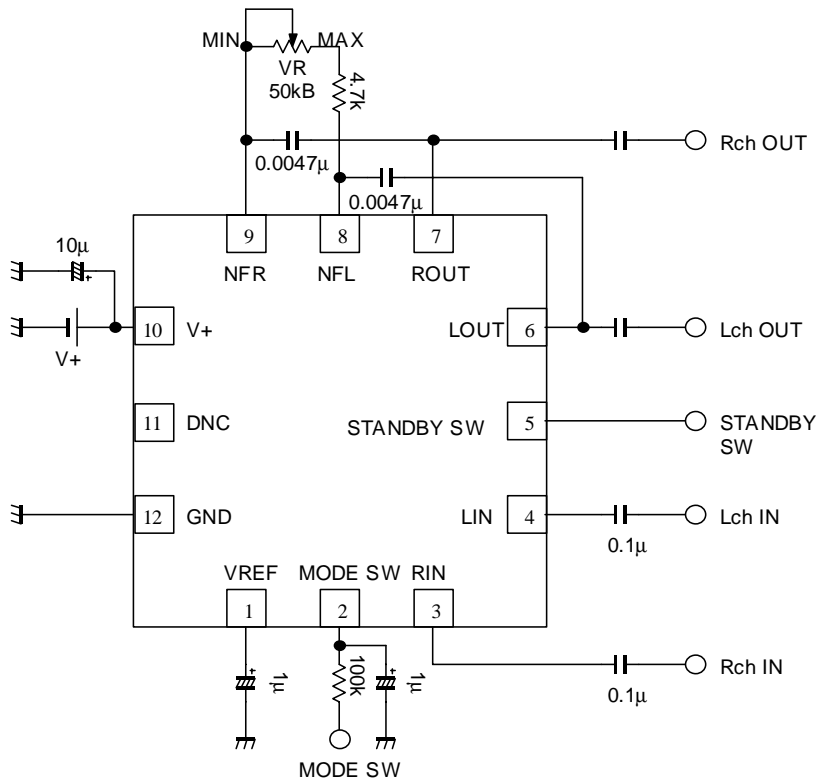

SSOP14

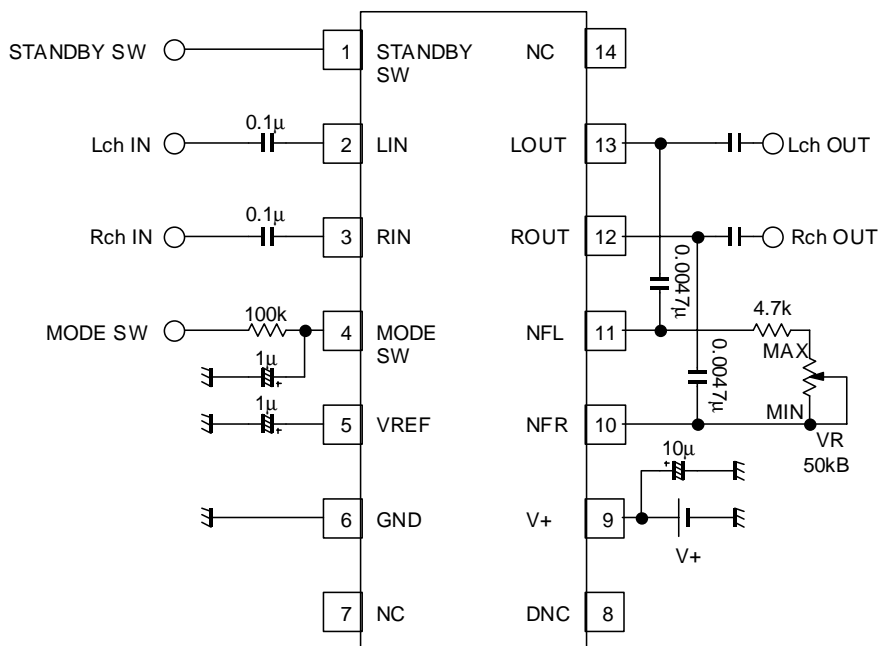

## TYPICAL CHARACTERISTICS

**Supply Current vs. Supply Voltage**

Ta=25degrees

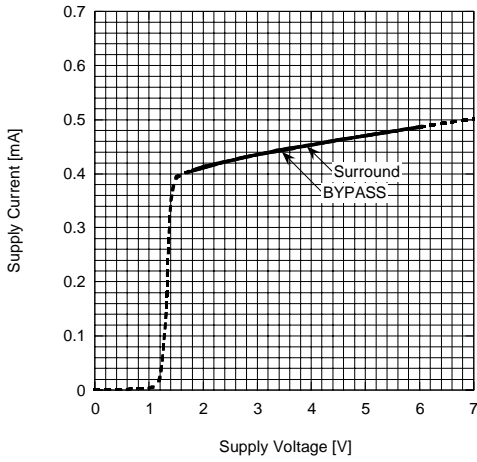

**Supply Current vs. Ambient Temperature**

V+=3V

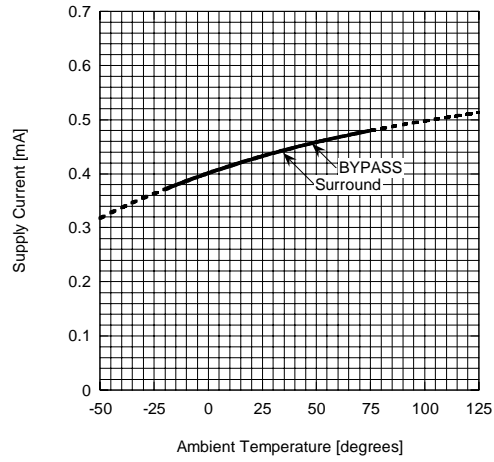

**Reference Voltage vs. Supply Voltage**

Ta=25degrees

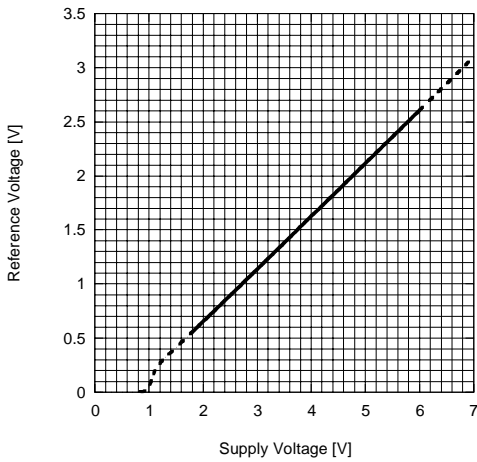

**Reference Voltage vs. Ambient Temperature**

V+=3V

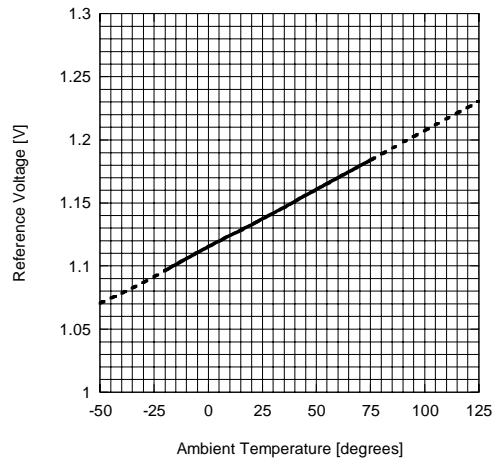

**Maximum Input Voltage vs. Supply Voltage (BYPASS)**

Vin=Lch f=1kHz Vout=Lch RL=10kohm  
THD=1% Ta=25degrees

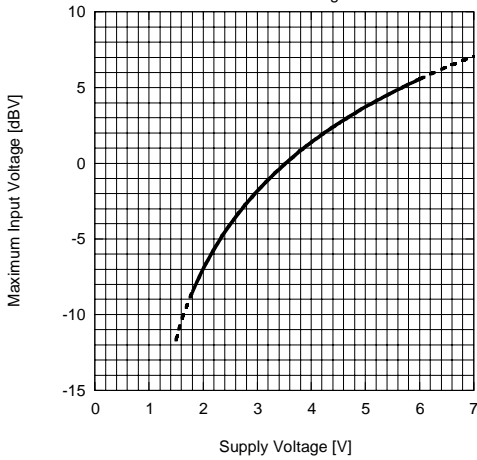

**Maximum Input Voltage vs. Supply Voltage (Surround)**

Vin=Lch f=100Hz Vout=Lch RL=10kohm VR=MAX  
THD=1% Ta=25degrees

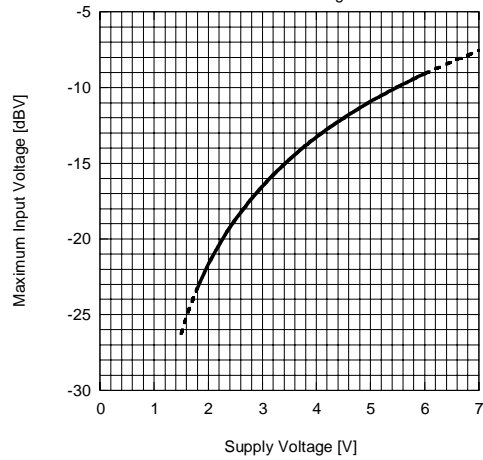



## TYPICAL CHARACTERISTICS

**Maximum Input Voltage vs. Ambient Temperature (BYPASS)**

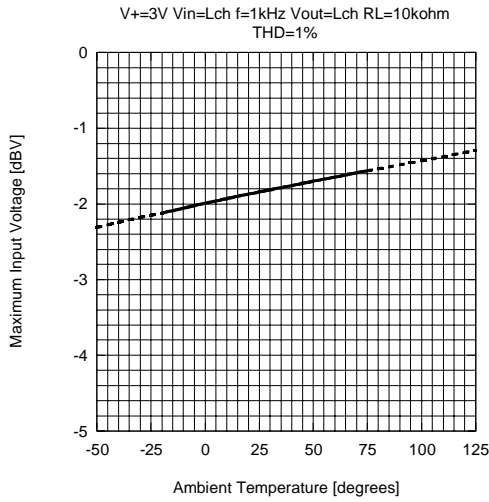

**Maximum Input Voltage vs. Ambient Temperature (Surround)**

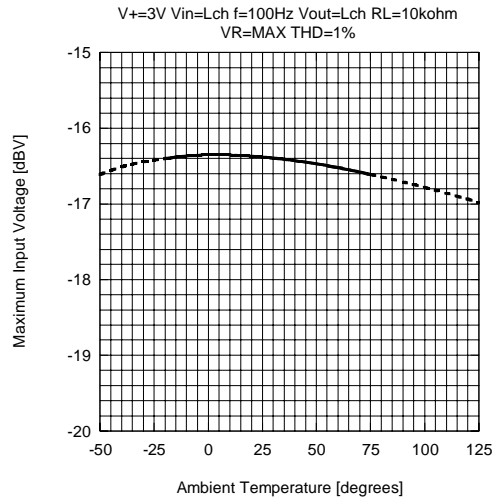

**Maximum Input Voltage vs. Ambient Temperature (BYPASS)**

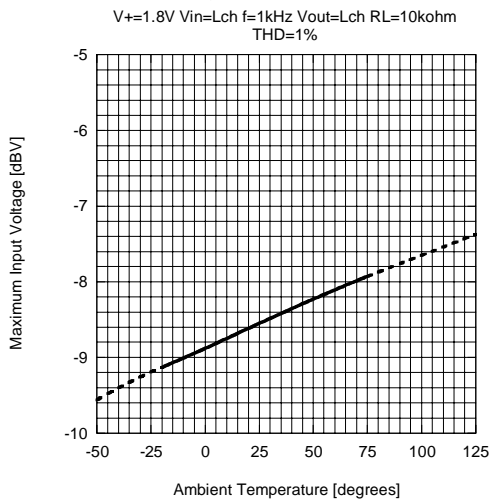

**Maximum Input Voltage vs. Ambient Temperature (Surround)**

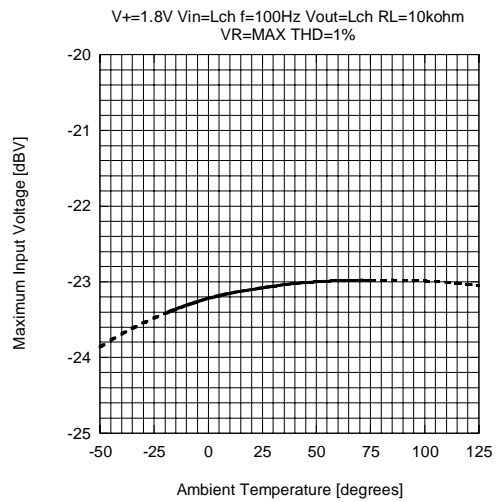

**Output Noise Voltage vs. Ambient Temperature**

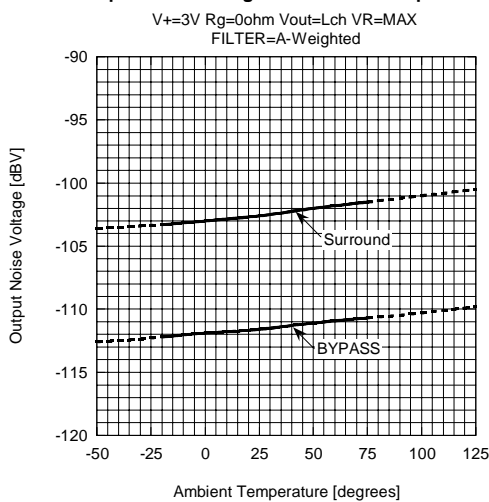

**Output Noise Voltage vs. Ambient Temperature**

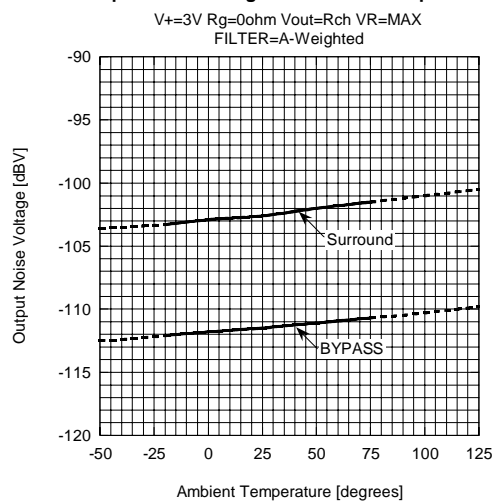

## TYPICAL CHARACTERISTICS

**Total Harmonic Distortion vs. Input Voltage (BYPASS)**

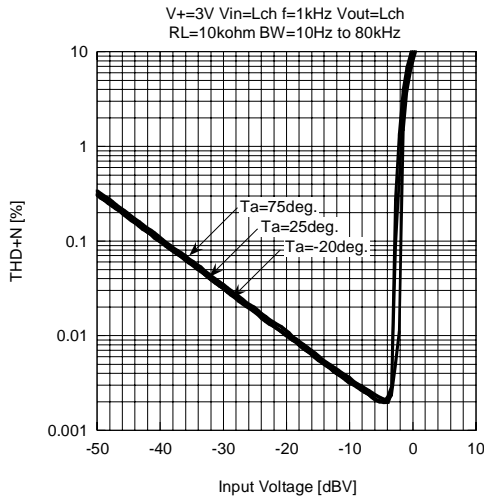

**Total Harmonic Distortion vs. Input Voltage (Surround)**

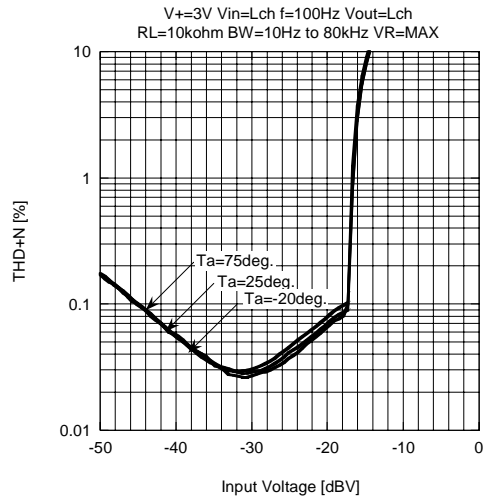

**Voltage Gain vs. Frequency (BYPASS)**

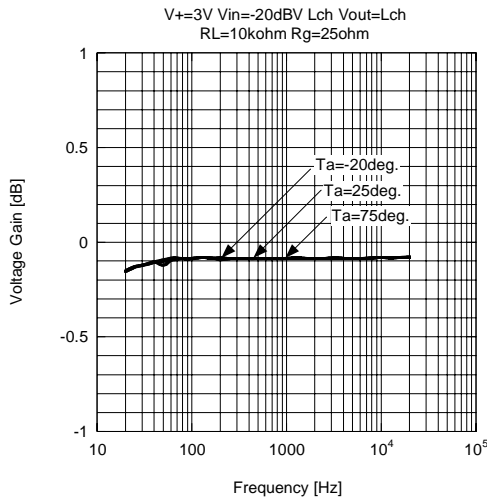

**Voltage Gain vs. Frequency (Surround)**

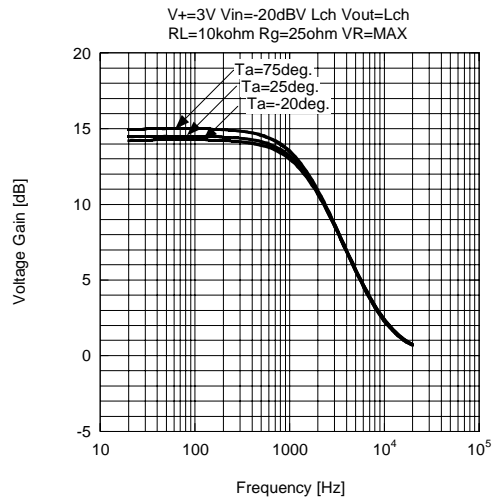

**Voltage Gain vs. Frequency (Surround)**

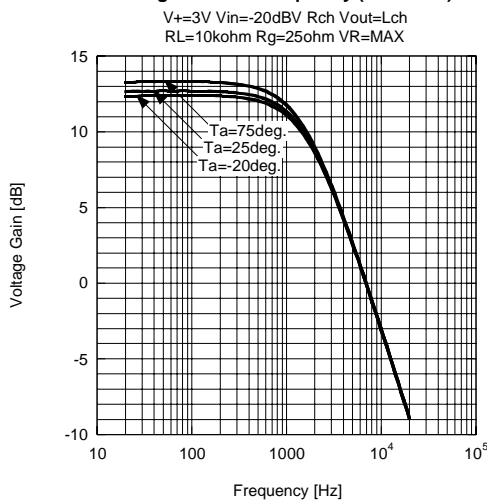

**Voltage Gain vs. Frequency (Surround)**

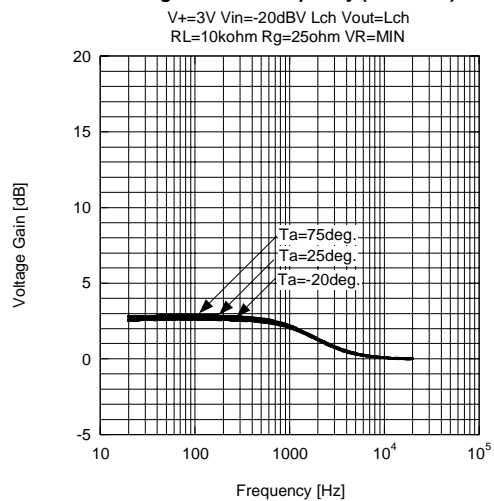

## TYPICAL CHARACTERISTICS

**Voltage Gain vs. SW Terminal Input Voltage**

V+=3V Vin=-20dBV Lch f=100Hz Vout=Lch VR=MAX  
BYPASS to Surround

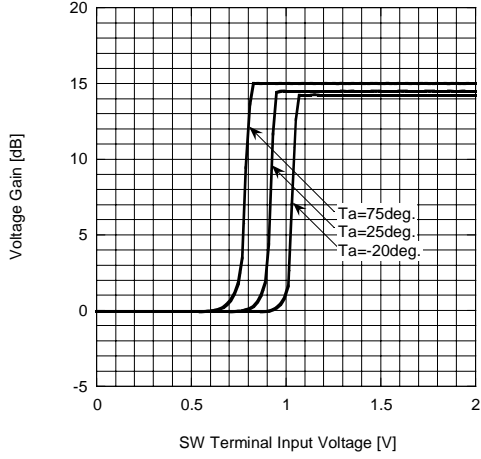

**Output DC Offset Voltage vs. Ambient Temperature**

V+=3V  
BYPASS to Surround

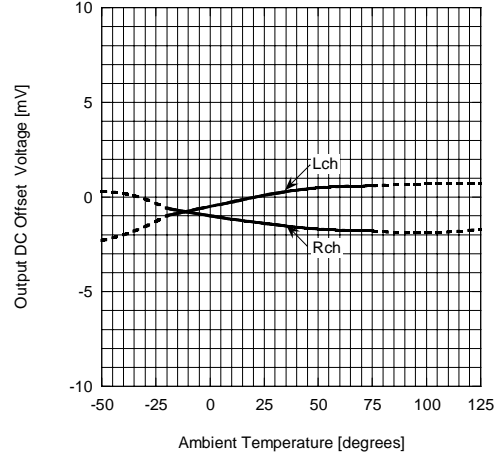

**[CAUTION]**

The specifications on this databook are only given for information, without any guarantee as regards either mistakes or omissions. The application circuits in this databook are described only to show representative usages of the product and not intended for the guarantee or permission of any right including the industrial rights.