

ADJUSTABLE LOW DROPOUT VOLTAGE REGULATOR

■ GENERAL DESCRIPTION

The NJM2397 is adjustable low dropout voltage regulator. The output current is up to 1.5A and dropout voltage is 0.2Vtyp. at $I_o=0.5A$.

The NJM2397 is suitable for power module, TV, Display, car stereo and low power applications.

■ FEATURE

- Low Dropout Voltage $\Delta V_{I, O}=0.2V$ typ. at $I_o=0.5A$
- Output Current $I_o(\text{max.})=1.5A$
- Reference Voltage $V_{\text{ref}}=1.29V$ typ.
- Internal Short Circuit Current Limit
- Internal Thermal Overload Protection
- Bipolar Technology
- Package Outline TO-220F(4pin)

■ PACKAGE OUTLINE

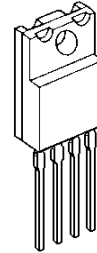

NJM2397F

■ PIN CONFIGURATION

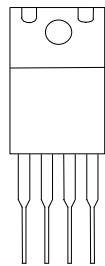

1 2 3 4
NJM2397F

PIN FUNCTION

1. V_{IN}
2. V_{OUT}
3. GND
4. ADJ

■ EQUIVALENT CIRCUIT

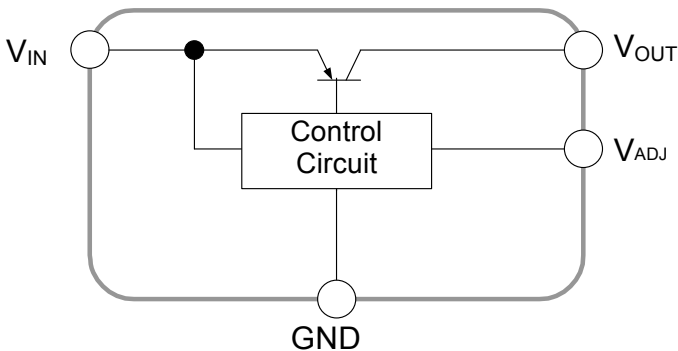

NJM2397

■ ABSOLUTE MAXIMUM RATINGS

(Ta=25°C)

PARAMETER	SYMBOL	RATINGS	UNIT
Input Voltage	V_{IN}	+35	V
Adjust terminal Voltage	V_{ADJ}	+6	V
Output Current	I_o	1.5	A
Power Dissipation	P_D	18(Tc<50°C)	W
Operating Junction Temperature Range	T_j	-40 to +150	°C
Operating Temperature Range	T_{opr}	-40 to 85	°C
Storage Temperature Range	T_{stg}	-50 to 150	°C

■ ELECTRICAL CHARACTERISTICS ($V_{IN}=15V$, $V_o=10V$, $I_o=0.5A$, $R_1=1k\Omega$, $C_{IN}=0.33\mu F$, $C_o=22\mu F$, $T_j=25^\circ C$)

Measurement is to be conducted is pulse testing.

PARAMETER	SYMBOL	CONDITIONS	MIN.	TYP.	MAX.	UNIT
Input Voltage	V_{IN}		3.8	-	35	V
Output Voltage	V_o		1.5	-	20	V
Reference Voltage	V_{ref}		1.238	1.29	1.342	V
Line Regulation	$\Delta V_o/\Delta V_{IN}$	$V_{IN}=V_o+1V\sim V_o+17V$	-	0.04	0.16	%/V
Load Regulation	$\Delta V_o/\Delta I_o$	$V_{IN}=V_o+2V$, $I_o=0A\sim 1.5A$	-	0.2	1.4	%/A
Average Temperature Coefficient of Output Voltage	$\Delta V_o/\Delta T$	$T_j=0\sim 125^\circ C$	-	± 0.02	-	%/°C
Quiescent Current	I_Q	$I_o=0A$	-	-	5	mA
Dropout Voltage	ΔV_{I_o}	$I_o=0.5A$	-	0.2	0.5	V
Ripple Rejection	RR	$V_{in}=V_o+2V$, $e_{in}=0.5V_{rms}$, $f=120Hz$	45	55	-	dB

■ TEST CIRCUIT

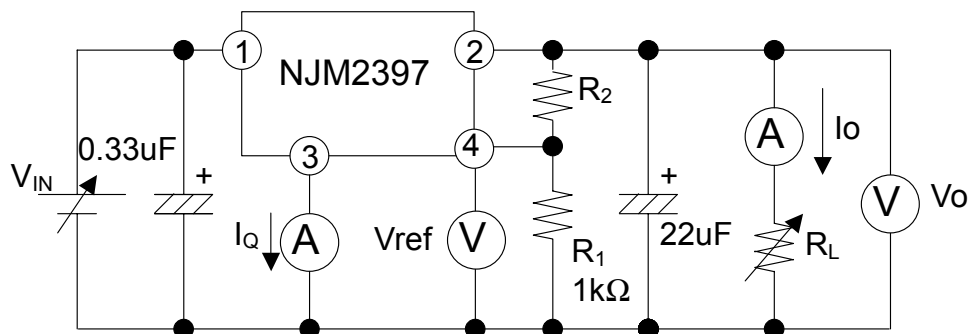

■ TYPICAL CHARACTERISTICS

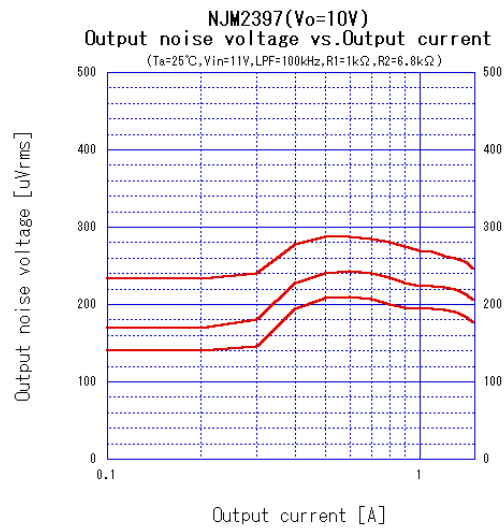
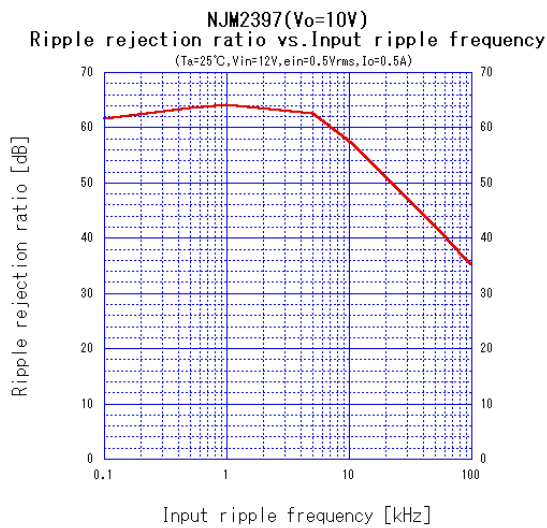
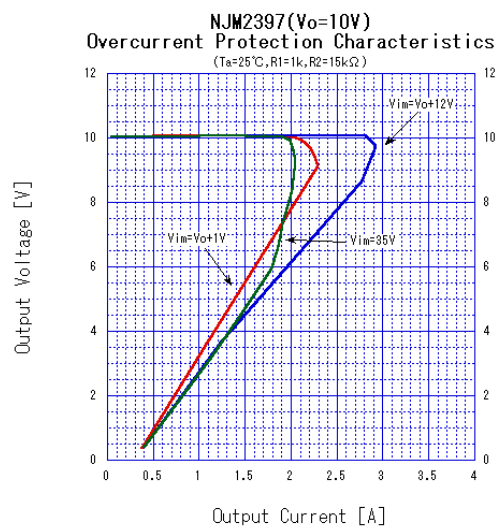
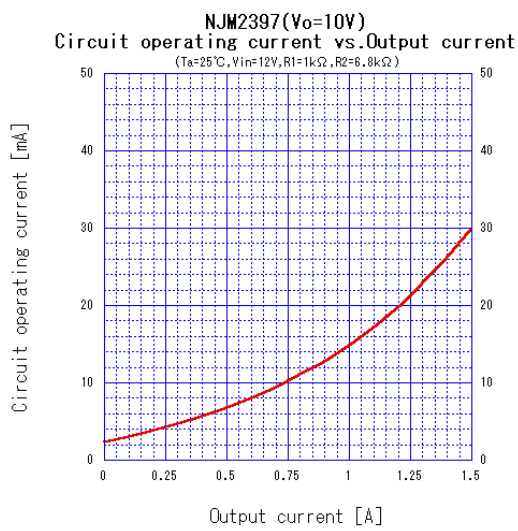
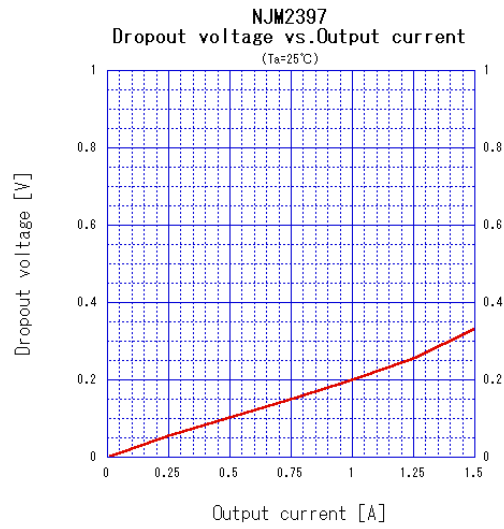
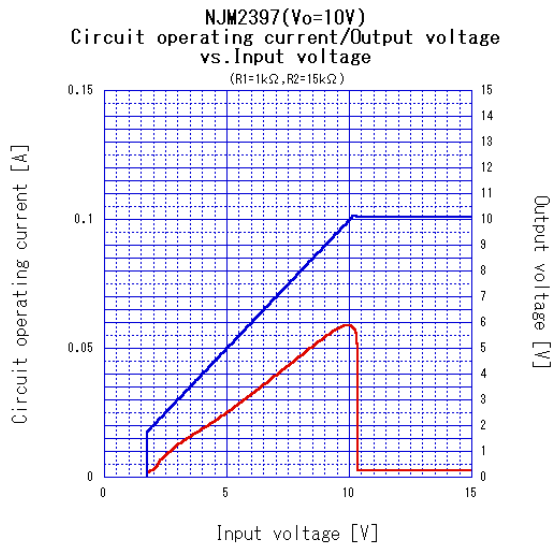

NJM2397

■ TYPICAL CHARACTERISTICS

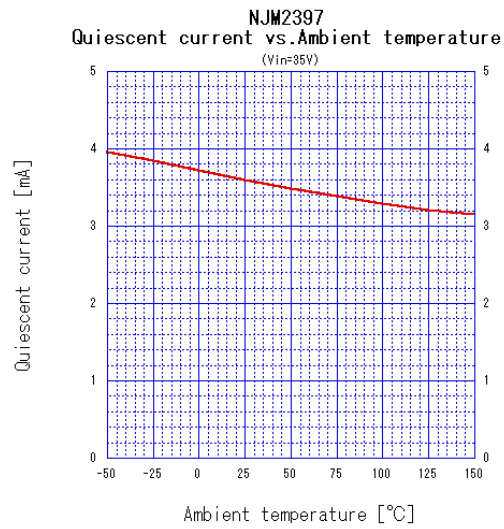
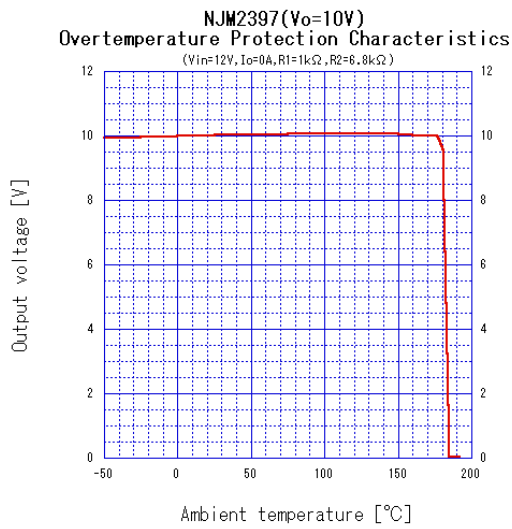
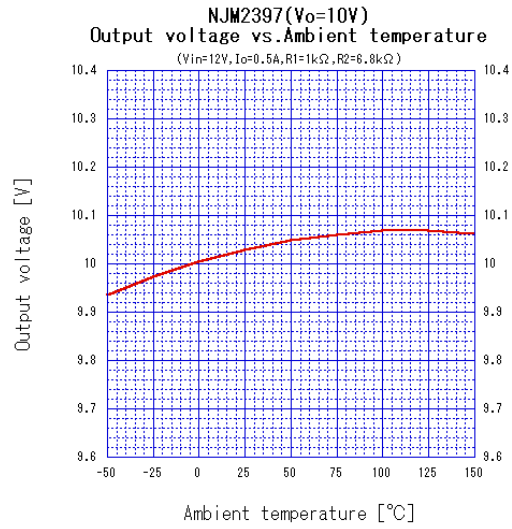
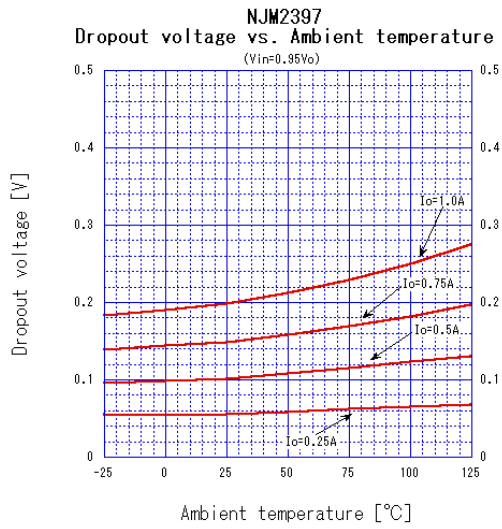

[CAUTION]

The specifications on this databook are only given for information, without any guarantee as regards either mistakes or omissions. The application circuits in this databook are described only to show representative usages of the product and not intended for the guarantee or permission of any right including the industrial rights.