

FEATURES

- EIA SIZES A (1210), B (1812) AND C (1008)
- EXCELLENT HIGH Q AND HIGH SRF CHARACTERISTICS
- BOTH FLOW AND REFLOW SOLDERING APPLICABLE
- HIGH INDUCTANCE AVAILABLE IN SMALL SIZE
- EMBOSSED PLASTIC TAPE PACKAGE FOR AUTOMATIC PICK-PLACE

**RoHS
Compliant**
includes all homogeneous materials
*See Part Number System for Details



AVAILABLE TYPE AND RANGE

EIA Size	Size Code	Size (L x W x H mm)	NIC Type	Inductance Range	Style
1008	C	2.5 x 2.0 x 1.6	NIN-FC	0.22 ~ 100 μ H	Standard
			NIN-NC	10nH ~ 0.82 μ H	High Frequency
			NIN-PC	1.0 ~ 33 μ H	High Current
1210	A	3.2 x 2.5 x 2.2	NIN-FA	0.22 ~ 220 μ H	Standard
			NIN-NA	47nH ~ 8.2 μ H	High Frequency
			NIN-PA	1.0 ~ 330 μ H	High Current
1812	B	4.5 x 3.2 x 3.2	NIN-FB	0.10 ~ 1000 μ H	Standard

SPECIFICATIONS

Specifications	Case Size		
	1008	1210	1812
Inductance Range	10nH ~ 100 μ H	47nH ~ 330 μ H	0.10 μ H ~ 1000 μ H
Inductance Tolerance	\pm 20% (M), \pm 10% (K), \pm 5% (J)		\pm 10% (K), \pm 5% (J)
Operating Temperature Range	-25°C ~ +85°C (at 100% of rated voltage)		
Insulation Resistance	1,000 MegOhm Min. (@ 100Vdc, Termination to Case)		
Withstanding Voltage	250 Vdc for 1 minute (Termination to Case)		
Q-Factor, Self Resonant Frequency DC Resistance, Rated DC Current and Inductance Tolerance	See Individual Product Listings		

ENVIRONMENTAL CHARACTERISTICS

Test	Specification	Test Method & Condition
Solderability	90% Min. Coverage	After 3 Sec. Dip in +230°C Solder Pot (Post Flux)
Humidity	(1) No Evidence of Damage	After 500 Hrs at 60°C and 90 ~ 95% RH
Soldering Effect	(2) Inductance Shall Be Within \pm 5% of initial Value	After 5 Seconds at -260°C (5 Min. 120°C Pre-Heat)
Low Frequency Vibration	(3) Q Factor Shall Be Within \pm 10 of initial Value	After 2 Hrs per Axis, 10 ~ 55Hz, 1.5 mm Ampl
Thermal Shock		After 100 cycles (-40° to +85°C) 30 Min. Each
Low Temperature Storage		After 500 Hrs at -40°C
High Temperature Load Life	(1) No Evidence of Damage (2) Inductance Shall Be Within \pm 10% of Initial Value	After 500 Hrs at +85°C with rated DC Current
Humidity Load Life	(3) Q Factor Shall Be Within \pm 10% of Initial Value	After 500 Hrs at 60°C with 90 ~ 95% RH with Rated DC Current

DIMENSIONS (mm)

SIZE A and C

SIZE B

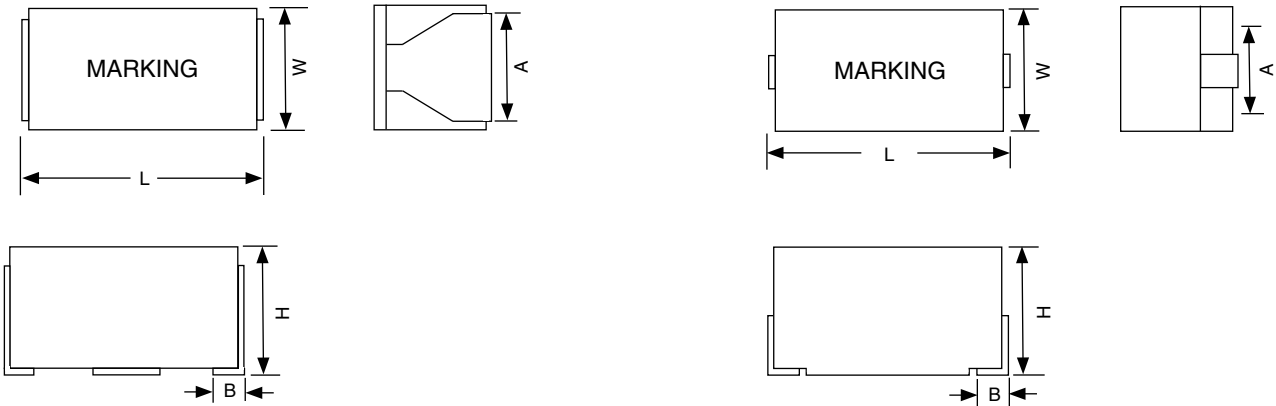

EIA Size	Size Code	Dim. L	Dim. W	Dim. H	Dim. A	Dim. B
1008	C	2.5 +0.3 -0.2	2.0 ± 0.2	1.6 ± 0.2	1.2 ± 0.1	0.4 ± 0.2
1210	A	3.2 ± 0.3	2.5 ± 0.2	2.2 ± 0.2	1.9 ± 0.1	0.6 ± 0.2
1812	B	4.5 ± 0.3	3.2 ± 0.2	3.2 ± 0.2	1.1 ± 0.2	1.2 ± 0.3

PART MARKING

Inductance Tolerance	Marking for Tolerance	Example
±20%	M	2R2M
±10%	No Identification	470
±5%	J	270J

(1) 3 digits system in μH

(2) R indicates decimal point in μH Ex: 2R7 = 2.7 μH
Ex: R18 = .18 μH = 180nH

(3) N indicates nanohenries (0.001 μH), Ex: 10N = 0.01 μH = 10nH

Applicable Guidelines:

1. Recommended soldering conditions :

Flow (wave): 250°C for 5 sec. max. (preheating of 120°C for 5 minutes.)

Reflow: 250°C for 10 sec. max., total time above 230°C is 40 sec. max. (preheating 150°C ~ 180°C/120 sec. max.)

2. Avoid placing inductor over any metal pattern on the PCB, which may create mutual inductance problems.

3. For mounting, it is suggested to secure chip inductor by means of epoxy adhesive curable by ultraviolet.

4. Ultrasonic cleaning is not recommended. If it is necessary, the cleaning conditions must be examined so as not to create mechanical damage by unexpected resonant vibration. Please contact our engineering department.

5. An excessive mechanical force may effect the electrical and magnetic properties of chip inductors. Make sure not to use any stress greater than 2Kg when component is placed.

PART NUMBER SYSTEM

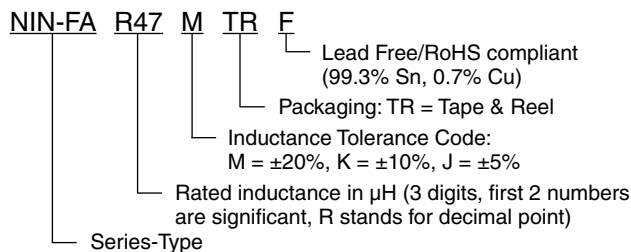

For Quality Factor (**Q**) and Inductance (**L**) over Frequency curves see www.RFpassives.com

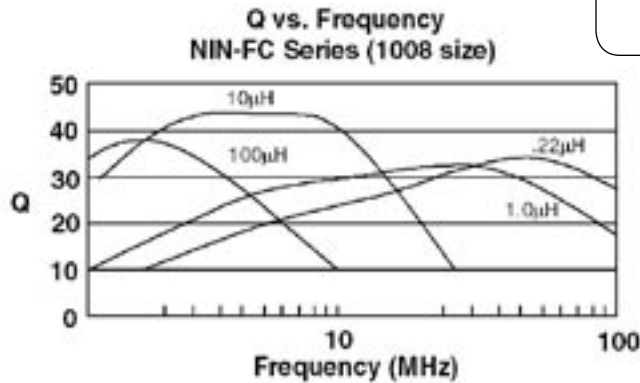

NIN-FC SERIES

C SIZE (1008)

STANDARD TYPE

NIC P/N	'L' Inductance (µH)	Tolerance		'Q' Factor (min.)	L & Q Test Freq.	SRF Mhz (min.)	DC Resistance (ohms) Max.	Rated DC Current (mA) Max.
		(std)	(opt)					
NIN-FCR22xTR	0.22	±20% (M)	±10% (K)	25	25.2 Mhz	230	0.70	190
NIN-FCR27xTR	0.27	±20% (M)	±10% (K)	25	25.2 Mhz	210	0.75	180
NIN-FCR33xTR	0.33	±20% (M)	±10% (K)	25	25.2 Mhz	190	0.85	170
NIN-FCR39xTR	0.39	±20% (M)	±10% (K)	25	25.2 Mhz	175	0.95	160
NIN-FCR47xTR	0.47	±20% (M)	±10% (K)	25	25.2 Mhz	160	1.00	155
NIN-FCR56xTR	0.56	±20% (M)	±10% (K)	25	25.2 Mhz	150	1.10	150
NIN-FCR68xTR	0.68	±20% (M)	±10% (K)	25	25.2 Mhz	135	1.25	140
NIN-FCR82xTR	0.82	±20% (M)	±10% (K)	25	25.2 Mhz	125	1.4	130
NIN-FC1R0 xTR	1.0	±10% (K)	±5% (J)	25	7.96 Mhz	115	0.65	195
NIN-FC1R2 xTR	1.2	±10% (K)	±5% (J)	25	7.96 Mhz	100	0.75	180
NIN-FC1R5 xTR	1.5	±10% (K)	±5% (J)	25	7.96 Mhz	90	0.85	170
NIN-FC1R8 xTR	1.8	±10% (K)	±5% (J)	25	7.96 Mhz	85	0.95	160
NIN-FC2R2xTR	2.2	±10% (K)	±5% (J)	25	7.96 Mhz	80	1.05	155
NIN-FC2R7 xTR	2.7	±10% (K)	±5% (J)	25	7.96 Mhz	75	1.20	145
NIN-FC3R3 xTR	3.3	±10% (K)	±5% (J)	25	7.96 Mhz	65	1.30	135
NIN-FC3R9 xTR	3.9	±10% (K)	±5% (J)	25	7.96 Mhz	60	1.40	130
NIN-FC4R7 xTR	4.7	±10% (K)	±5% (J)	25	7.96 Mhz	55	1.55	125
NIN-FC5R6 xTR	5.6	±10% (K)	±5% (J)	25	7.96 Mhz	50	1.75	120
NIN-FC6R8 xTR	6.8	±10% (K)	±5% (J)	25	7.96 Mhz	45	1.95	115
NIN-FC8R2 xTR	8.2	±10% (K)	±5% (J)	25	7.96 Mhz	40	2.20	105
NIN-FC100 xTR	10	±10% (K)	±5% (J)	25	2.52 Mhz	32	3.50	80
NIN-FC120 xTR	12	±10% (K)	±5% (J)	25	2.52 Mhz	30	3.80	75
NIN-FC150 xTR	15	±10% (K)	±5% (J)	25	2.52 Mhz	28	4.40	70
NIN-FC180 xTR	18	±10% (K)	±5% (J)	25	2.52 Mhz	25	5.00	65
NIN-FC220 xTR	22	±10% (K)	±5% (J)	25	2.52 Mhz	22	5.80	60
NIN-FC270 xTR	27	±10% (K)	±5% (J)	20	2.52 Mhz	21	6.30	115
NIN-FC330 xTR	33	±10% (K)	±5% (J)	20	2.52 Mhz	20	7.10	110
NIN-FC390 xTR	39	±10% (K)	±5% (J)	20	2.52 Mhz	18	9.50	90
NIN-FC470 xTR	47	±10% (K)	±5% (J)	20	2.52 Mhz	17	11.0	80
NIN-FC560 xTR	56	±10% (K)	±5% (J)	20	2.52 Mhz	16	12.1	75
NIN-FC680 xTR	68	±10% (K)	±5% (J)	20	2.52 Mhz	15	16.6	70
NIN-FC820 xTR	82	±10% (K)	±5% (J)	20	2.52 Mhz	13	19.0	65
NIN-FC101 xTR	100	±10% (K)	±5% (J)	15	0.796 Mhz	12	21.0	60



Q vs Frequency
NIN-NC Series (1008 size)
High Frequency Type

For Quality Factor (Q) and Inductance (L) over Frequency curves see www.RFpassives.com

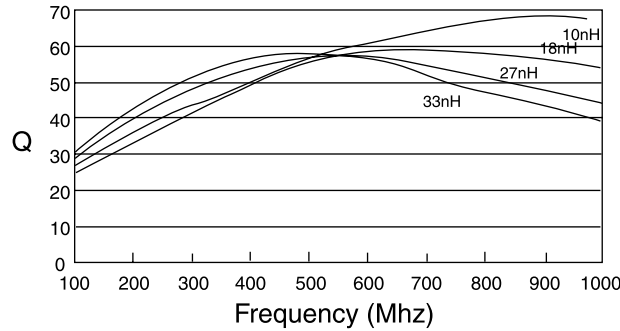

NIN-NC SERIES C SIZE (1008) HIGH FREQUENCY TYPE

NIC P/N	'L' Inductance (nH)	Tolerance		'Q' Factor (min.)	L & Q Test Freq.	SRF Mhz (min.)	DC Resistance (ohms) Max.	Rated DC Current (mA) Max.
		(std)	(opt)					
NIN-NC10NKTR	10	±10% (K)	---	10	100 Mhz	2500	0.32	280
NIN-NC12NKTR	12	±10% (K)	---	10	100 Mhz	2200	0.34	270
NIN-NC15NKTR	15	±10% (K)	---	10	100 Mhz	1800	0.38	255
NIN-NC18NKTR	18	±10% (K)	---	10	100 Mhz	1550	0.40	250
NIN-NC22NKTR	22	±10% (K)	---	15	100 Mhz	1350	0.43	240
NIN-NC27NKTR	27	±10% (K)	---	15	100 Mhz	1150	0.47	230
NIN-NC33NxTR	33	±10% (K)	±5% (J)	15	100 Mhz	1000	0.51	220
NIN-NC39NxTR	39	±10% (K)	±5% (J)	15	100 Mhz	890	0.55	215
NIN-NC47NxTR	47	±10% (K)	±5% (J)	15	100 Mhz	770	0.59	205
NIN-NC56NxTR	56	±10% (K)	±5% (J)	15	100 Mhz	670	0.63	200
NIN-NC68NxTR	68	±10% (K)	±5% (J)	15	100 Mhz	590	0.68	190
NIN-NC82NxTR	82	±10% (K)	±5% (J)	15	100 Mhz	520	0.73	185
NIN-NCR10xTR	100	±10% (K)	±5% (J)	10	25.2 Mhz	460	0.80	175
NIN-NCR12xTR	120	±10% (K)	±5% (J)	10	25.2 Mhz	400	0.87	170
NIN-NCR15xTR	150	±10% (K)	±5% (J)	10	25.2 Mhz	340	0.98	160
NIN-NCR18xTR	180	±10% (K)	±5% (J)	10	25.2 Mhz	300	1.05	155
NIN-NCR22xTR	220	±10% (K)	±5% (J)	10	25.2 Mhz	260	1.15	145
NIN-NCR27xTR	270	±10% (K)	±5% (J)	10	25.2 Mhz	230	1.25	140
NIN-NCR33xTR	330	±10% (K)	±5% (J)	10	25.2 Mhz	200	1.37	135
NIN-NCR39xTR	390	±10% (K)	±5% (J)	10	25.2 Mhz	180	1.47	130
NIN-NCR47xTR	470	±10% (K)	±5% (J)	10	25.2 Mhz	160	1.58	125
NIN-NCR56xTR	560	±10% (K)	±5% (J)	10	25.2 Mhz	145	1.70	120
NIN-NCR68xTR	680	±10% (K)	±5% (J)	10	25.2 Mhz	130	1.85	110
NIN-NCR82xTR	820	±10% (K)	±5% (J)	10	25.2 Mhz	100	2.10	100

For Quality Factor (**Q**) and Inductance (**L**)
over Frequency curves
see www.RFpassives.com

NIN-PC SERIES C SIZE (1008) HIGH CURRENT TYPE

NIC P/N	'L' Inductance (μH)	Tolerance		'Q' Factor (min.)	L & Q Test Freq.	SRF Mhz (min.)	DC Resistance (ohms) Max.	Rated DC Current (mA) Max.
		(std)	(opt)					
NIN-PC1R0MTR	1.0	±20%	---	10	7.96 Mhz	95	0.45	475
NIN-PC1R5MTR	1.5	±20%	---	10	7.96 Mhz	85	0.55	435
NIN-PC2R2MTR	2.2	±20%	---	10	7.96 Mhz	65	0.65	390
NIN-PC3R3MTR	3.3	±20%	---	8	7.96 Mhz	55	0.85	340
NIN-PC4R7MTR	4.7	±20%	---	8	7.96 Mhz	43	1.2	285
NIN-PC6R8KTR	6.8	±10%	---	8	7.96 Mhz	39	1.3	275
NIN-PC100KTR	10	±10%	---	20	2.52 Mhz	32	2.2	210
NIN-PC120KTR	12	±10%	---	20	2.52 Mhz	25	2.7	195
NIN-PC150KTR	15	±10%	---	20	2.52 Mhz	21	3.2	175
NIN-PC220KTR	22	±10%	---	20	2.52 Mhz	18	4.0	160
NIN-PC330KTR	33	±10%	---	20	2.52 Mhz	16	6.5	120

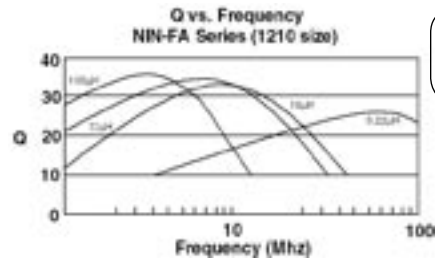

For Quality Factor (Q) and Inductance (L) over Frequency curves see www.RFpassives.com

NIN-FA SERIES A SIZE (1210) STANDARD TYPE

NIC P/N	'L' Inductance (μH)	Tolerance		'Q' Factor (min.)	L & Q Test Freq.	SRF Mhz (min.)	DC Resistance (ohms) Max.	Rated DC Current (mA) Max.
		(std)	(opt)					
NIN-FAR22xTR	0.22	±20% (M)	±10% (K)	25	25.2 Mhz	230	0.29	360
NIN-FAR27xTR	0.27	±20% (M)	±10% (K)	25	25.2 Mhz	210	0.32	345
NIN-FAR33xTR	0.33	±20% (M)	±10% (K)	25	25.2 Mhz	190	0.35	330
NIN-FAR39xTR	0.39	±20% (M)	±10% (K)	25	25.2 Mhz	175	0.39	305
NIN-FAR47xTR	0.47	±20% (M)	±10% (K)	25	25.2 Mhz	160	0.44	290
NIN-FAR56xTR	0.56	±20% (M)	±10% (K)	25	25.2 Mhz	150	0.49	275
NIN-FAR68xTR	0.68	±20% (M)	±10% (K)	25	25.2 Mhz	135	0.55	260
NIN-FAR82xTR	0.82	±20% (M)	±10% (K)	25	25.2 Mhz	125	0.61	245
NIN-FA1R0xTR	1.0	±10% (K)	±5% (J)	30	7.96 Mhz	115	0.69	230
NIN-FA1R2xTR	1.2	±10% (K)	±5% (J)	30	7.96 Mhz	100	0.75	215
NIN-FA1R5xTR	1.5	±10% (K)	±5% (J)	30	7.96 Mhz	90	0.75	210
NIN-FA1R8xTR	1.8	±10% (K)	±5% (J)	30	7.96 Mhz	85	0.82	200
NIN-FA2R2xTR	2.2	±10% (K)	±5% (J)	30	7.96 Mhz	80	0.95	190
NIN-FA2R7xTR	2.7	±10% (K)	±5% (J)	30	7.96 Mhz	75	1.1	180
NIN-FA3R3xTR	3.3	±10% (K)	±5% (J)	30	7.96 Mhz	65	1.2	180
NIN-FA3R9xTR	3.9	±10% (K)	±5% (J)	30	7.96 Mhz	60	1.3	175
NIN-FA4R7xTR	4.7	±10% (K)	±5% (J)	30	7.96 Mhz	55	1.5	165
NIN-FA5R6xTR	5.6	±10% (K)	±5% (J)	30	7.96 Mhz	50	1.6	160
NIN-FA6R8xTR	6.8	±10% (K)	±5% (J)	30	7.96 Mhz	45	1.8	150
NIN-FA8R2xTR	8.2	±10% (K)	±5% (J)	30	7.96 Mhz	40	2.0	140
NIN-FA100xTR	10	±10% (K)	±5% (J)	30	2.52 Mhz	36	2.1	140
NIN-FA120xTR	12	±10% (K)	±5% (J)	30	2.52 Mhz	33	2.5	125
NIN-FA150xTR	15	±10% (K)	±5% (J)	30	2.52 Mhz	30	2.8	120
NIN-FA180xTR	18	±10% (K)	±5% (J)	30	2.52 Mhz	27	3.3	110
NIN-FA220xTR	22	±10% (K)	±5% (J)	30	2.52 Mhz	25	3.7	105
NIN-FA270xTR	27	±10% (K)	±5% (J)	30	2.52 Mhz	22	5.0	90
NIN-FA330xTR	33	±10% (K)	±5% (J)	30	2.52 Mhz	20	5.6	85
NIN-FA390xTR	39	±10% (K)	±5% (J)	30	2.52 Mhz	20	6.4	80
NIN-FA470xTR	47	±10% (K)	±5% (J)	30	2.52 Mhz	15	7.0	75
NIN-FA560xTR	56	±10% (K)	±5% (J)	30	2.52 Mhz	15	8.0	70
NIN-FA680xTR	68	±10% (K)	±5% (J)	30	2.52 Mhz	15	9.0	65
NIN-FA820xTR	82	±10% (K)	±5% (J)	30	2.52 Mhz	11	10	60
NIN-FA101xTR	100	±10% (K)	±5% (J)	20	0.796 Mhz	10	10	60
NIN-FA121xTR	120	±10% (K)	±5% (J)	20	0.796 Mhz	10	11	55
NIN-FA151xTR	150	±10% (K)	±5% (J)	20	0.796 Mhz	8	15	50
NIN-FA181xTR	180	±10% (K)	±5% (J)	20	0.796 Mhz	7	17	50
NIN-FA221xTR	220	±10% (K)	±5% (J)	20	0.796 Mhz	7	21	45

Q vs Frequency NIN-NA Series (1210 Size)

For Quality Factor (**Q**) and Inductance (**L**) over Frequency curves see www.RFpassives.com

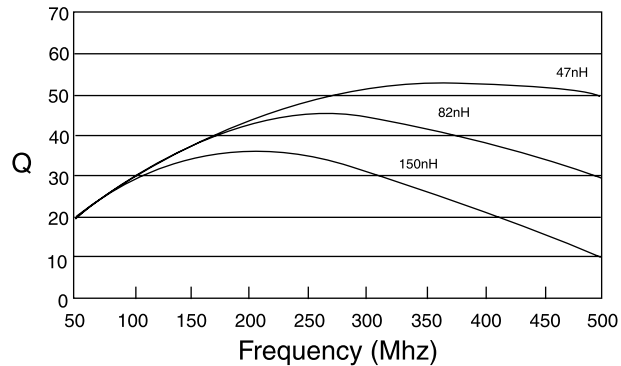

NIN-NA SERIES A SIZE (1210) HIGH FREQUENCY

NIC P/N	'L' Inductance (μH)	Tolerance	'Q' Factor (min.)	L & Q Test Freq.	SRF Mhz (min.)	DC Resistance (ohms) Max.	Rated DC Current (mA) Max.
NIN-NA47NMTR	0.047	±20% (M)	10	100 Mhz	680	0.20	450
NIN-NA56NMTR	0.056	±20% (M)	10	100 Mhz	600	0.22	420
NIN-NA68NMTR	0.068	±20% (M)	10	100 Mhz	540	0.25	400
NIN-NA82NMTR	0.082	±20% (M)	10	100 Mhz	500	0.27	380
NIN-NAR10MTR	0.10	±20% (M)	10	100 Mhz	450	0.30	360
NIN-NAR12MTR	0.12	±20% (M)	10	25.2 Mhz	400	0.67	240
NIN-NAR15MTR	0.15	±20% (M)	10	25.2 Mhz	350	0.72	230
NIN-NAR18MTR	0.18	±20% (M)	10	25.2 Mhz	320	0.81	220
NIN-NAR22KTR	0.22	±10% (K)	10	25.2 Mhz	280	0.90	210
NIN-NAR27KxTR	0.27	±10% (K)	10	25.2 Mhz	250	1.0	200
NIN-NAR33KTR	0.33	±10% (K)	10	25.2 Mhz	220	1.1	190
NIN-NAR39KTR	0.39	±10% (K)	10	25.2 Mhz	200	1.2	180
NIN-NAR47KTR	0.47	±10% (K)	10	25.2 Mhz	180	1.4	175
NIN-NAR56KTR	0.56	±10% (K)	10	25.2 Mhz	160	1.5	170
NIN-NAR68KTR	0.68	±10% (K)	10	25.2 Mhz	150	1.7	155
NIN-NAR82KTR	0.82	±10% (K)	10	25.2 Mhz	135	1.9	145
NIN-NA1R0JTR	1.0	±5% (J)	13	7.96 Mhz	120	2.1	125
NIN-NA1R2JTR	1.2	±5% (J)	13	7.96 Mhz	110	2.3	120
NIN-NA1R5JTR	1.5	±5% (J)	13	7.96 Mhz	95	2.7	115
NIN-NA1R8JTR	1.8	±5% (J)	13	7.96 Mhz	85	3.0	110
NIN-NA2R2JTR	2.2	±5% (J)	13	7.96 Mhz	80	3.2	110
NIN-NA2R7JTR	2.7	±5% (J)	13	7.96 Mhz	70	3.6	105
NIN-NA3R3JTR	3.3	±5% (J)	13	7.96 Mhz	62	4.2	100
NIN-NA3R9JTR	3.9	±5% (J)	13	7.96 Mhz	57	4.4	95
NIN-NA4R7JTR	4.7	±5% (J)	13	7.96 Mhz	52	7.7	70
NIN-NA5R6JTR	5.6	±5% (J)	13	7.96 Mhz	46	8.7	65
NIN-NA6R8JTR	6.8	±5% (J)	13	7.96 Mhz	42	10	60
NIN-NA8R2JTR	8.2	±5% (J)	13	7.96 Mhz	38	11	60

For Quality Factor (**Q**) and Inductance (**L**)
over Frequency curves
see www.RFpassives.com

NIN-PA SERIES A SIZE (1210) HIGH CURRENT TYPE

NIC P/N	'L' Inductance (μH)	Tolerance		'Q' Factor (min.)	L & Q Test Freq.	SRF Mhz (min.)	DC Resistance (ohms) Max.	Rated DC Current (mA) Max.
		(std)	(opt)					
NIN-PA1R0MTR	1.0	±20% (M)	----	7	7.96 Mhz	150	0.15	600
NIN-PA1R5MTR	1.5	±20% (M)	----	7	7.96 Mhz	110	0.18	550
NIN-PA2R2MTR	2.2	±20% (M)	----	7	7.96 Mhz	80	0.23	500
NIN-PA3R3MTR	3.3	±20% (M)	----	7	7.96 Mhz	58	0.28	400
NIN-PA4R7MTR	4.7	±20% (M)	----	7	7.96 Mhz	46	0.34	350
NIN-PA6R8MTR	6.8	±20% (M)	----	7	7.96 Mhz	38	0.42	300
NIN-PA100KTR	10	±10% (K)	----	15	2.52 Mhz	23	0.50	240
NIN-PA120KTR	12	±10% (K)	----	15	2.52 Mhz	21	0.60	230
NIN-PA150KTR	15	±10% (K)	----	15	2.52 Mhz	18	0.74	220
NIN-PA180KTR	18	±10% (K)	----	15	2.52 Mhz	17	0.90	205
NIN-PA220KTR	22	±10% (K)	----	15	2.52 Mhz	15	1.15	185
NIN-PA270KTR	27	±10% (K)	----	15	2.52 Mhz	13	1.45	165
NIN-PA330KTR	33	±10% (K)	----	15	2.52 Mhz	12	1.65	155
NIN-PA390KTR	39	±10% (K)	----	15	2.52 Mhz	11	1.90	145
NIN-PA470KTR	47	±10% (K)	----	15	2.52 Mhz	9.5	2.25	135
NIN-PA560KTR	56	±10% (K)	----	15	2.52 Mhz	8.5	3.30	110
NIN-PA680KTR	68	±10% (K)	----	15	2.52 Mhz	7.5	3.70	105
NIN-PA820KTR	82	±10% (K)	----	15	2.52 Mhz	7.0	4.20	100
NIN-PA101KTR	100	±10% (K)	----	20	0.796 Mhz	6.5	5.0	90
NIN-PA121KTR	120	±10% (K)	----	20	0.796 Mhz	6.0	7.0	75
NIN-PA151KTR	150	±10% (K)	----	20	0.796 Mhz	5.5	8.0	70
NIN-PA181KTR	180	±10% (K)	----	20	0.796 Mhz	5.0	9.5	65
NIN-PA221KTR	220	±10% (K)	----	20	0.796 Mhz	4.0	11.0	60
NIN-PA271KTR	270	±10% (K)	----	20	0.796 Mhz	3.5	14.5	55
NIN-PA331KTR	330	±10% (K)	----	20	0.796 Mhz	3.0	16.0	50

For Quality Factor (**Q**) and Inductance (**L**)
over Frequency curves
see www.RFpassives.com

NIN-FB SERIES

B-SIZE (1812)

STANDARD VALUES

NIC P/N	'L' Inductance (uH)	Tolerance		'Q' Factor (min.)	L & Q Test Freq.	SRF Mhz (min.)	DC Resistance (ohms) Max.	Rated DC Current (mA) Max.
		(std)	(opt)					
NIN-FBR10xTR	0.10	±20% (M)	±10% (K)	28	25.2 Mhz	700	0.44	450
NIN-FBR12xTR	0.12	±20% (M)	±10% (K)	30	25.2 Mhz	500	0.22	450
NIN-FBR15xTR	0.15	±20% (M)	±10% (K)	30	25.2 Mhz	450	0.25	450
NIN-FBR18xTR	0.18	±20% (M)	±10% (K)	30	25.2 Mhz	400	0.28	450
NIN-FBR22xTR	0.22	±20% (M)	±10% (K)	30	25.2 Mhz	350	0.32	450
NIN-FBR27xTR	0.27	±20% (M)	±10% (K)	30	25.2 Mhz	320	0.36	450
NIN-FBR33xTR	0.33	±20% (M)	±10% (K)	30	25.2 Mhz	300	0.40	450
NIN-FBR39xTR	0.39	±20% (M)	±10% (K)	30	25.2 Mhz	250	0.45	450
NIN-FBR47xTR	0.47	±20% (M)	±10% (K)	30	25.2 Mhz	220	0.50	450
NIN-FBR56xTR	0.56	±20% (M)	±10% (K)	30	25.2 Mhz	180	0.55	450
NIN-FBR68xTR	0.68	±20% (M)	±10% (K)	30	25.2 Mhz	160	0.60	450
NIN-FBR82xTR	0.82	±20% (M)	±10% (K)	30	25.2 Mhz	140	0.67	450
NIN-FB1R0xTR	1.0	±20% (M)	±10% (K)	50	7.96 Mhz	100	0.50	450
NIN-FB1R2xTR	1.2	±20% (M)	±10% (K)	50	7.96 Mhz	80	0.55	430
NIN-FB1R5xTR	1.5	±20% (M)	±10% (K)	50	7.96 Mhz	70	0.60	410
NIN-FB1R8xTR	1.8	±20% (M)	±10% (K)	50	7.96 Mhz	60	0.65	390
NIN-FB2R2xTR	2.2	±20% (M)	±10% (K)	50	7.96 Mhz	55	0.70	380
NIN-FB2R7xTR	2.7	±20% (M)	±10% (K)	50	7.96 Mhz	50	0.75	370
NIN-FB3R3xTR	3.3	±20% (M)	±10% (K)	50	7.96 Mhz	45	0.80	355
NIN-FB3R9xTR	3.9	±20% (M)	±10% (K)	50	7.96 Mhz	40	0.90	330
NIN-FB4R7xTR	4.7	±20% (M)	±10% (K)	50	7.96 Mhz	35	1.0	315
NIN-FB5R6xTR	5.6	±20% (M)	±10% (K)	50	7.96 Mhz	33	1.1	300
NIN-FB6R8xTR	6.8	±10% (K)	±5% (J)	50	7.96 Mhz	27	1.2	285
NIN-FB8R2xTR	8.2	±10% (K)	±5% (J)	50	7.96 Mhz	25	1.4	270

For Quality Factor (**Q**) and Inductance (**L**)
over Frequency curves
see www.RFpassives.com

NIN-FB SERIES B-SIZE (1812) STANDARD VALUES

NIC P/N	'L' Inductance (μ H)	Tolerance		'Q' Factor (min.)	L & Q Test Freq.	SRF Mhz (min.)	DC Resistance (ohms) Max.	Rated DC Current (mA) Max.
		(std)	(opt)					
NIN-FB100xTR	10	$\pm 10\%$ (K)	$\pm 5\%$ (J)	50	2.52 Mhz	20	1.6	250
NIN-FB120xTR	12	$\pm 10\%$ (K)	$\pm 5\%$ (J)	50	2.52 Mhz	18	2.0	225
NIN-FB150xTR	15	$\pm 10\%$ (K)	$\pm 5\%$ (J)	50	2.52 Mhz	17	2.5	200
NIN-FB180xTR	18	$\pm 10\%$ (K)	$\pm 5\%$ (J)	50	2.52 Mhz	15	2.8	190
NIN-FB220xTR	22	$\pm 10\%$ (K)	$\pm 5\%$ (J)	50	2.52 Mhz	13	3.2	180
NIN-FB270xTR	27	$\pm 10\%$ (K)	$\pm 5\%$ (J)	50	2.52 Mhz	12	3.6	170
NIN-FB330xTR	33	$\pm 10\%$ (K)	$\pm 5\%$ (J)	50	2.52 Mhz	11	4.0	160
NIN-FB390xTR	39	$\pm 10\%$ (K)	$\pm 5\%$ (J)	50	2.52 Mhz	10	4.5	150
NIN-FB470xTR	47	$\pm 10\%$ (K)	$\pm 5\%$ (J)	50	2.52 Mhz	10	5.0	140
NIN-FB560xTR	56	$\pm 10\%$ (K)	$\pm 5\%$ (J)	50	2.52 Mhz	9.3	5.5	135
NIN-FB680xTR	68	$\pm 10\%$ (K)	$\pm 5\%$ (J)	50	2.52 Mhz	9.0	6.0	130
NIN-FB820xTR	82	$\pm 10\%$ (K)	$\pm 5\%$ (J)	50	2.52 Mhz	8.2	7.0	120
NIN-FB101xTR	100	$\pm 10\%$ (K)	$\pm 5\%$ (J)	40	2.52 Mhz	6.7	8.8	110
NIN-FB121xTR	120	$\pm 10\%$ (K)	$\pm 5\%$ (J)	40	1.5 Mhz	6.1	10	110
NIN-FB151xTR	150	$\pm 10\%$ (K)	$\pm 5\%$ (J)	40	1.5 Mhz	5.5	11	105
NIN-FB181xTR	180	$\pm 10\%$ (K)	$\pm 5\%$ (J)	40	1.5 Mhz	5.1	13	102
NIN-FB221xTR	220	$\pm 10\%$ (K)	$\pm 5\%$ (J)	40	0.796 Mhz	4.5	13	100
NIN-FB271xTR	270	$\pm 10\%$ (K)	$\pm 5\%$ (J)	40	0.796 Mhz	4.1	14	85
NIN-FB331xTR	330	$\pm 10\%$ (K)	$\pm 5\%$ (J)	40	0.796 Mhz	3.7	16	85
NIN-FB391xTR	390	$\pm 10\%$ (K)	$\pm 5\%$ (J)	40	0.796 Mhz	3.3	19	80
NIN-FB471xTR	470	$\pm 10\%$ (K)	$\pm 5\%$ (J)	40	0.796 Mhz	3.3	31	55
NIN-FB561xTR	560	$\pm 10\%$ (K)	$\pm 5\%$ (J)	30	0.796 Mhz	2.7	35	50
NIN-FB681xTR	680	$\pm 10\%$ (K)	$\pm 5\%$ (J)	30	0.796 Mhz	2.5	39	50
NIN-FB821xTR	820	$\pm 10\%$ (K)	$\pm 5\%$ (J)	30	0.796 Mhz	2.4	45	30
NIN-FB102xTR	1000	$\pm 10\%$ (K)	$\pm 5\%$ (J)	30	0.796 Mhz	2.1	53	30

PACKAGING SPECIFICATIONS

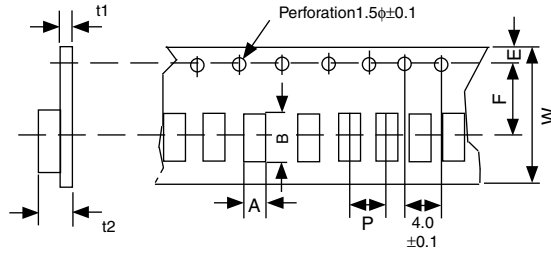

CARRIER TAPE DIMENSIONS (mm)

Case Code	Type	Size	W ±0.3	A ±0.2	B ±0.2	P ±0.1	E ±0.1	F ±0.1	t1	t2
B	FC/NC/PC	C	8.0	2.4	2.9	4.0	1.75	3.5	0.25	1.85
C	FA/NA/PA	A	8.0	2.8	3.6	4.0	1.75	3.5	0.25	2.4
D	FB	B	12.0	3.6	4.9	8.0	1.75	5.5	0.3	3.5

DIMENSIONS (mm)

Case Code	Type	Size	D \varnothing ±2	W ±1.5	Qty/Reel
B	FC/NC/PC	C	180	9.0	2000 pcs
C	FA/NA/PA	A	180	9.0	2000 pcs
D	FB	B	180	13.0	500 pcs

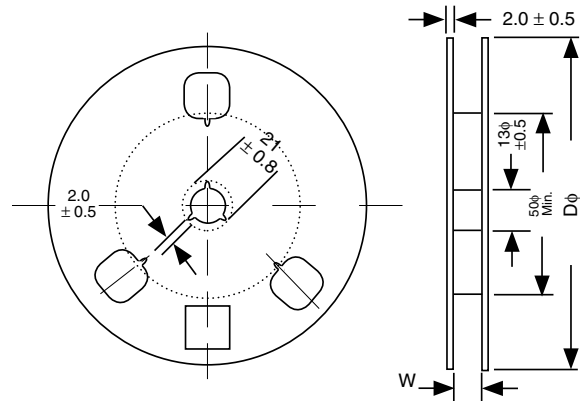

RECOMMENDED LAND PATTERNS FOR FLOW AND REFLOW SOLDERING

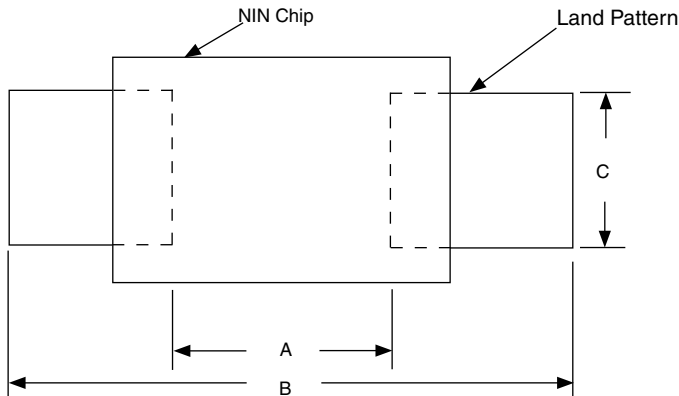

DIMENSIONS (mm)

	Type	Size	A	B	C
B	FC/NC/PC	C	1.4~1.5	3.5~4.0	1.2~1.6
C	FA/NA/PA	A	1.6~2.0	4.0~4.6	1.9~2.4
D	FB	B	2.4~2.6	5.5~6.0	2.0~3.0