



NPN SILICON HIGH FREQUENCY TRANSISTOR

NE662M16

FEATURES

- **HIGH GAIN BANDWIDTH:** $f_T = 25$ GHz
- **LOW NOISE FIGURE:** $NF = 1.1$ dB at 2 GHz
- **HIGH MAXIMUM STABLE GAIN:** 20 dB at $f = 2$ GHz
- **NEW LOW PROFILE M16 PACKAGE:**
 - Flat Lead Style with a height of just 0.50mm

DESCRIPTION

NEC's NE662M16 is fabricated using NEC's UHS0 25 GHz f_T wafer process. With a typical transition frequency of 25 GHz the NE662M16 is usable in applications from 100 MHz to over 10 GHz. The NE662M16 provides excellent low voltage/low current performance.

NEC's new low profile/flat lead style "M16" package is ideal for today's portable wireless applications. The NE662M16 is an ideal choice for LNA and oscillator requirements in all mobile communication systems.

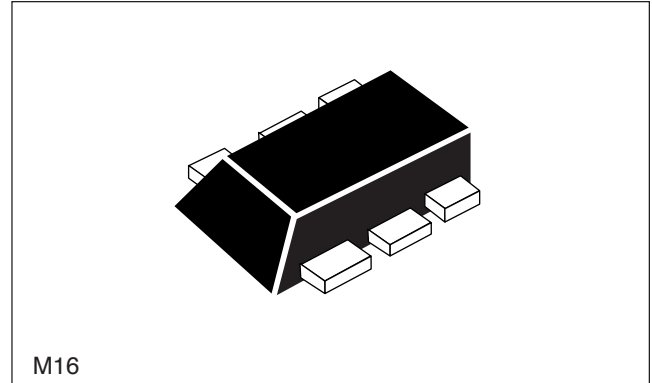

ELECTRICAL CHARACTERISTICS (TA = 25°C)

		PART NUMBER EIAJ ¹ REGISTERED NUMBER PACKAGE OUTLINE	NE662M16 2SC5704 M16			
SYMBOLS		PARAMETERS AND CONDITIONS	UNITS	MIN	TYP	MAX
DC	ICBO	Collector Cutoff Current at $V_{CB} = 5V, I_E = 0$	nA			200
	IEBO	Emitter Cutoff Current at $V_{EB} = 1V, I_C = 0$	nA			200
	hFE	Forward Current Gain ² at $V_{CE} = 2V, I_C = 5mA$		50	70	100
RF	f_T	Gain Bandwidth at $V_{CE} = 3V, I_C = 30mA, f = 2GHz$	GHz	20	25	
	MSG	Maximum Stable Gain ⁴ at $V_{CE} = 2V, I_C = 20mA, f = 2GHz$	dB		20	
	$ S_{21E} ^2$	Insertion Power Gain at $V_{CE} = 2V, I_C = 20mA, f = 2GHz$	dB	14	17	
	NF	Noise Figure at $V_{CE} = 2V, I_C = 5mA, f = 2GHz, Z_{IN} = Z_{OPT}$	dB		1.1	1.5
	P _{1dB}	Output Power at 1 dB compression point at $V_{CE} = 2V, I_C = 20mA, f = 2GHz$	dBm		11	
	IP ₃	Third Order Intercept Point at $V_{CE} = 2V, I_C = 20mA, f = 2GHz$			22	
	Cre	Feedback Capacitance ³ at $V_{CB} = 2V, I_C = 0, f = 1MHz$	pF		0.14	0.24

Notes:

1. Electronic Industrial Association of Japan.
2. Pulsed measurement, pulse width $\leq 350 \mu s$, duty cycle $\leq 2\%$.
3. Capacitance is measured by capacitance meter (automatic balance bridge method) when emitter pin is connected to the guard pin.

4. $MSG = \left| \frac{S_{21}}{S_{12}} \right|$

ABSOLUTE MAXIMUM RATINGS¹ (T_A = 25°C)

SYMBOLS	PARAMETERS	UNITS	RATINGS
V _{CB0}	Collector to Base Voltage	V	15
V _{CE0}	Collector to Emitter Voltage	V	3.3
V _{EB0}	Emitter to Base Voltage	V	1.5
I _C	Collector Current	mA	35
P _T	Total Power Dissipation	mW	115
T _J	Junction Temperature	°C	150
T _{STG}	Storage Temperature	°C	-65 to +150

Note:

1. Operation in excess of any one of these parameters may result in permanent damage.

ORDERING INFORMATION

PART NUMBER	QUANTITY	PACKAGING
NE662M16-T3-A	10 kpcs/reel	Pin 1 (Collector), Pin 6 (Emitter) face the perforation side on the tape.

OUTLINE DIMENSIONS (Units in mm)

PACKAGE OUTLINE M16

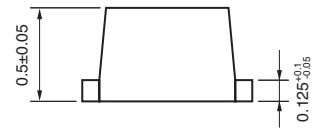
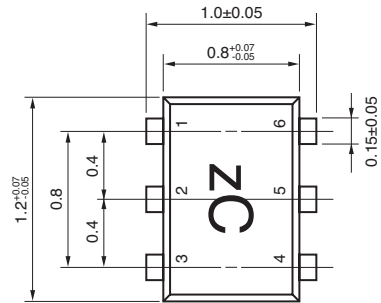

PIN CONNECTIONS

- | | |
|--------------|------------|
| 1. Collector | 4. Base |
| 2. Emitter | 5. Emitter |
| 3. Emitter | 6. Emitter |

TYPICAL PERFORMANCE CURVES (TA = 25°C)

TOTAL POWER DISSIPATION vs. AMBIENT TEMPERATURE

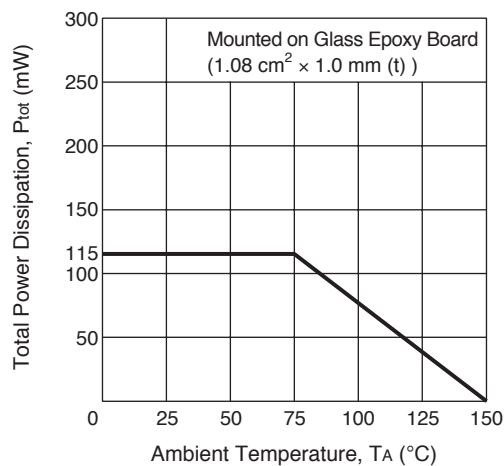

REVERSE TRANSFER CAPACITANCE vs. COLLECTOR TO BASE VOLTAGE

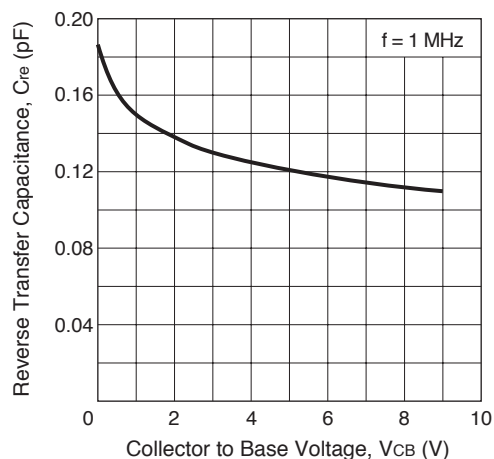

COLLECTOR CURRENT vs. BASE TO EMITTER VOLTAGE

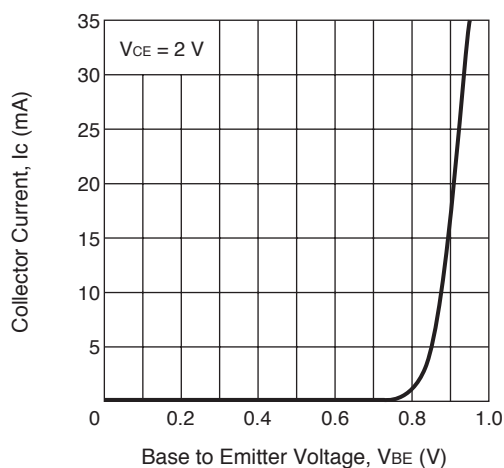

COLLECTOR CURRENT vs. COLLECTOR TO EMITTER VOLTAGE

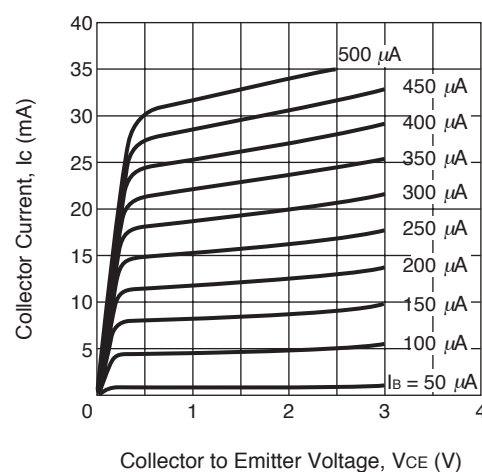

DC CURRENT GAIN vs. COLLECTOR CURRENT

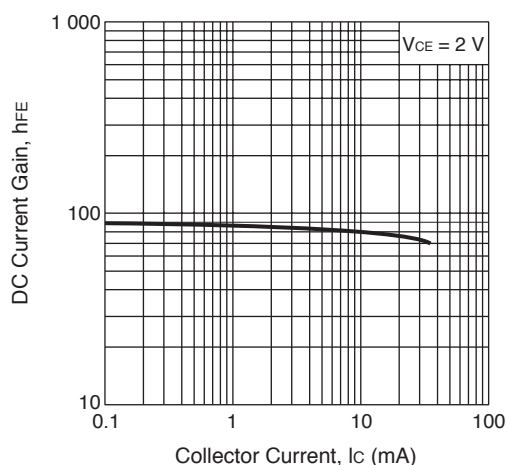

GAIN BANDWIDTH vs. COLLECTOR CURRENT

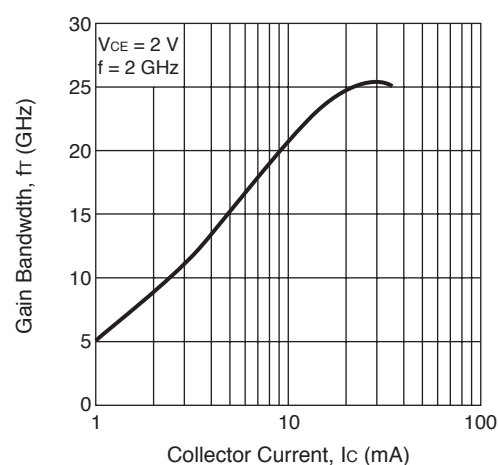

TYPICAL PERFORMANCE CURVES (TA = 25°C)

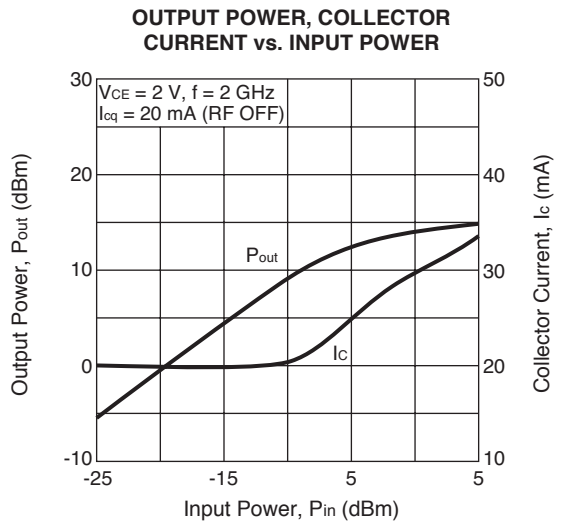
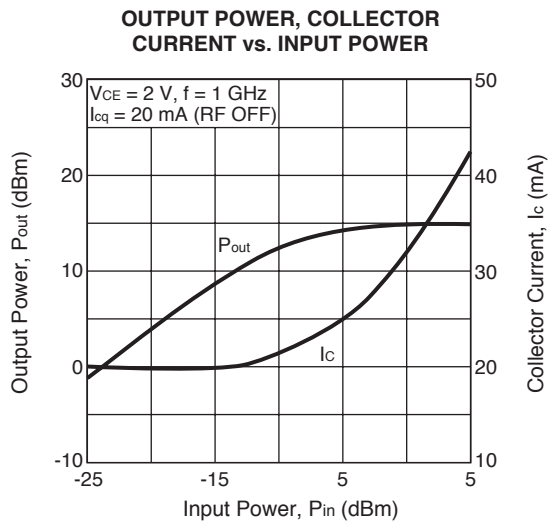
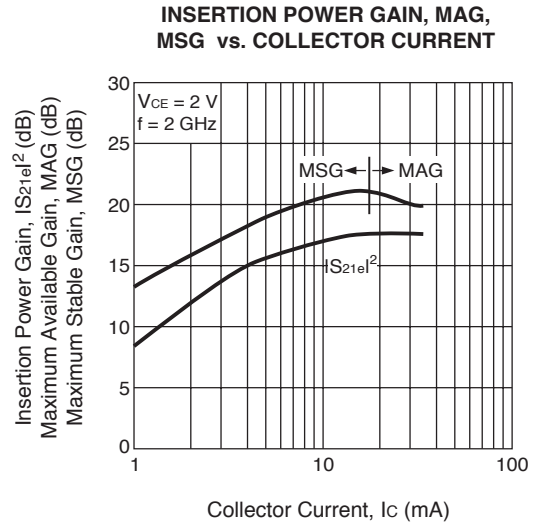
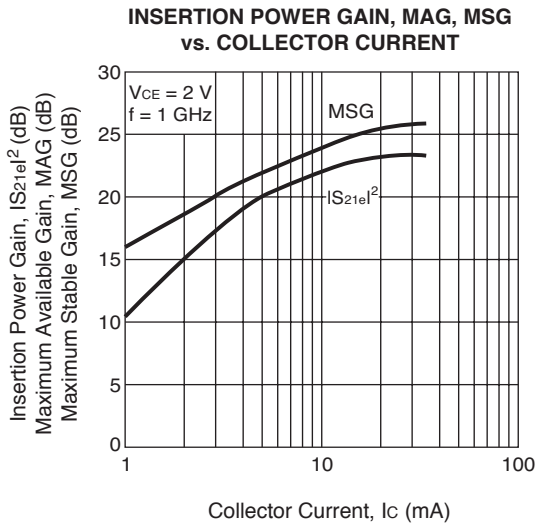
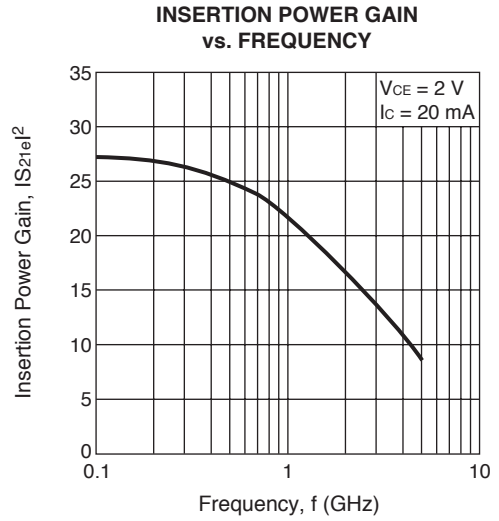
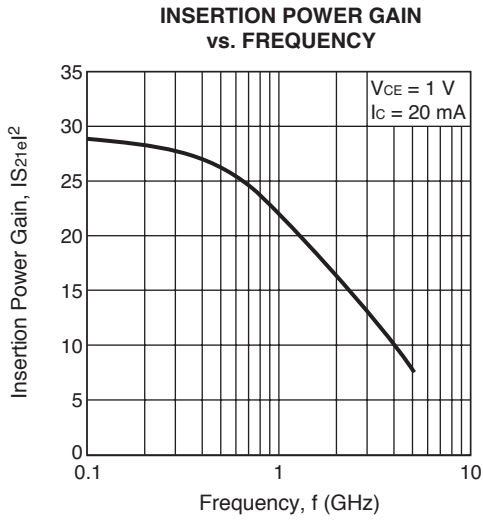

TYPICAL PERFORMANCE CURVES (T_A = 25°C)

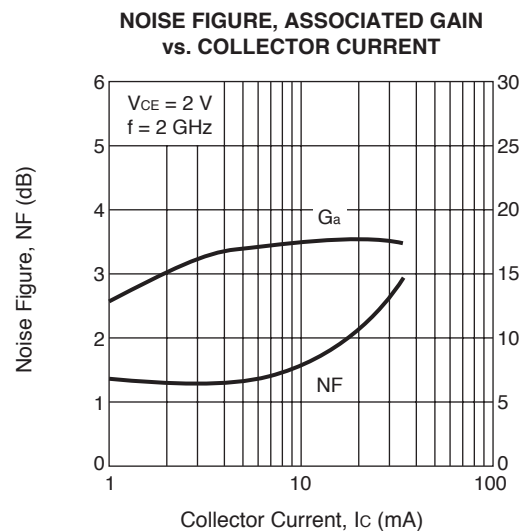
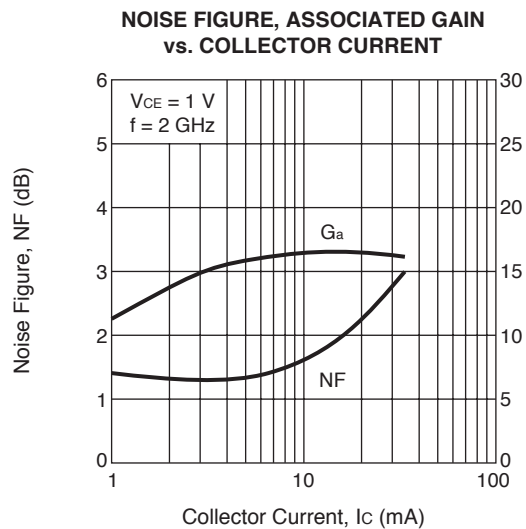
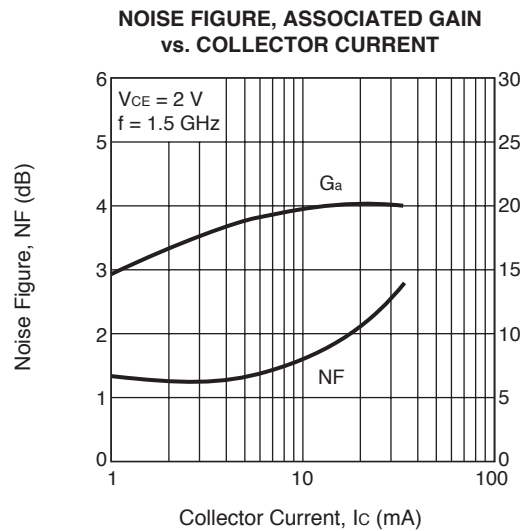
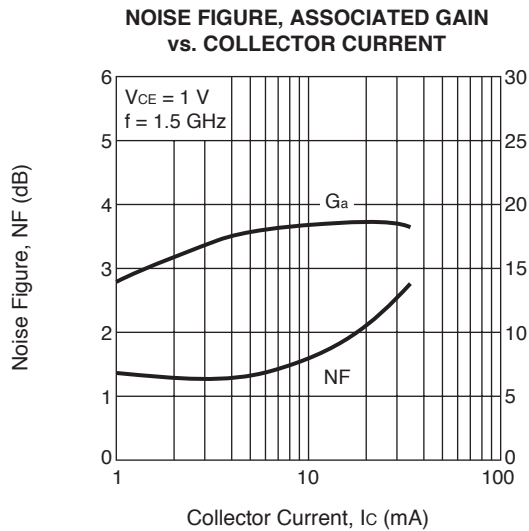
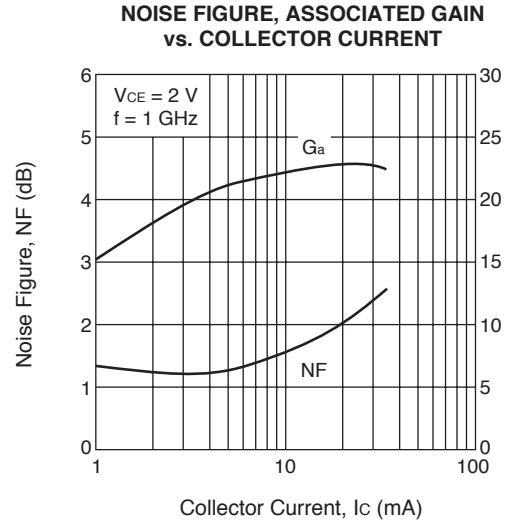
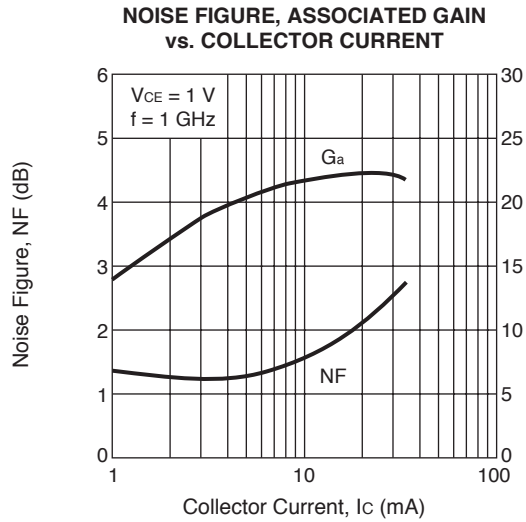

NE662M16

TYPICAL SCATTERING PARAMETERS (T_A = 25°C)

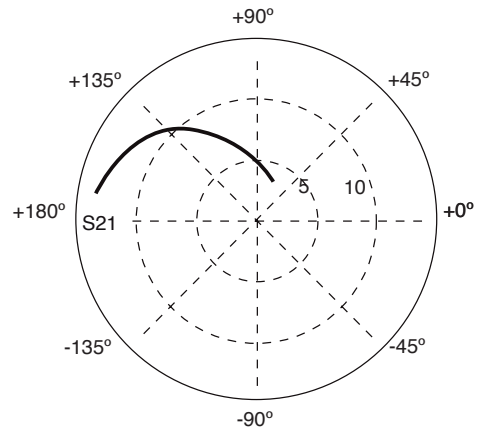
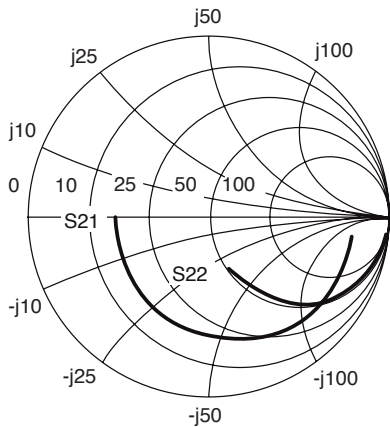

NE662M16

V_c = 2 V, I_c = 5 mA

FREQUENCY GHz	S ₁₁		S ₂₁		S ₁₂		S ₂₂		K	MAG ¹ (dB)
	MAG	ANG	MAG	ANG	MAG	ANG	MAG	ANG		
0.100	0.79	-8.34	13.52	171.32	0.01	84.69	0.98	-5.81	0.13	32.18
0.200	0.79	-20.52	13.20	165.06	0.02	78.92	0.96	-11.66	0.09	29.17
0.300	0.78	-30.77	12.77	158.29	0.02	73.38	0.93	-16.99	0.11	27.36
0.400	0.76	-39.87	12.28	152.12	0.03	68.92	0.90	-21.91	0.14	26.09
0.500	0.74	-48.66	11.75	146.29	0.04	64.34	0.87	-26.38	0.17	25.11
0.600	0.73	-56.79	11.15	140.96	0.04	60.23	0.83	-30.37	0.20	24.28
0.700	0.71	-64.12	10.59	136.12	0.05	56.71	0.79	-33.94	0.24	23.60
0.800	0.69	-71.30	10.02	131.99	0.05	53.36	0.76	-37.10	0.26	22.99
0.900	0.68	-77.50	9.48	128.20	0.05	50.48	0.72	-39.91	0.29	22.47
1.000	0.66	-83.36	8.98	124.77	0.06	47.89	0.69	-42.40	0.32	21.99
1.100	0.65	-88.67	8.55	121.61	0.06	45.67	0.66	-44.60	0.35	21.59
1.200	0.64	-93.70	8.15	118.55	0.06	43.73	0.64	-46.56	0.38	21.22
1.300	0.64	-98.23	7.79	115.75	0.06	42.02	0.61	-48.38	0.40	20.88
1.400	0.63	-102.48	7.45	113.15	0.07	40.50	0.59	-49.89	0.43	20.57
1.500	0.62	-106.53	7.14	110.70	0.07	39.06	0.57	-51.38	0.46	20.28
1.600	0.61	-110.24	6.82	108.22	0.07	37.77	0.55	-52.58	0.49	19.99
1.700	0.60	-113.97	6.57	105.79	0.07	36.69	0.53	-53.71	0.52	19.74
1.800	0.60	-117.60	6.36	103.81	0.07	35.72	0.51	-54.81	0.55	19.54
1.900	0.59	-120.80	6.11	102.01	0.07	34.87	0.50	-55.74	0.58	19.31
2.000	0.58	-124.09	5.86	99.85	0.07	34.09	0.48	-56.51	0.61	19.06
2.100	0.58	-127.67	5.69	97.73	0.07	33.33	0.47	-57.44	0.64	18.89
2.200	0.57	-130.76	5.51	95.62	0.07	32.59	0.46	-57.89	0.66	18.68
2.300	0.57	-133.98	5.37	94.20	0.08	32.26	0.44	-58.61	0.68	18.53
2.400	0.56	-136.85	5.16	92.25	0.08	31.81	0.43	-59.18	0.71	18.31
2.500	0.56	-139.86	5.03	90.06	0.08	31.21	0.42	-59.83	0.74	18.17
2.600	0.55	-142.72	4.88	88.26	0.08	30.84	0.41	-60.32	0.77	17.98
2.700	0.55	-145.66	4.75	86.62	0.08	30.55	0.40	-60.89	0.80	17.83
2.800	0.54	-148.25	4.58	84.94	0.08	30.18	0.39	-61.28	0.83	17.63
2.900	0.54	-151.04	4.46	82.99	0.08	30.00	0.38	-61.71	0.87	17.50
3.000	0.53	-153.76	4.35	81.42	0.08	29.61	0.37	-62.28	0.90	17.34
3.100	0.52	-156.67	4.21	79.85	0.08	29.45	0.36	-62.64	0.93	17.17
3.200	0.52	-159.41	4.09	78.16	0.08	29.21	0.36	-63.08	0.96	17.02
3.300	0.52	-162.03	4.00	76.53	0.08	28.97	0.35	-63.54	0.99	16.88
3.400	0.52	-164.80	3.89	75.17	0.08	28.78	0.34	-64.05	1.02	15.94
3.500	0.51	-167.55	3.78	73.64	0.08	28.67	0.33	-64.59	1.05	15.28
3.600	0.51	-170.15	3.68	71.91	0.08	28.50	0.32	-65.11	1.07	14.77
3.700	0.51	-172.65	3.61	70.42	0.08	28.28	0.32	-65.78	1.09	14.44
3.800	0.51	-174.91	3.51	69.29	0.08	28.15	0.31	-66.41	1.12	14.02
3.900	0.51	-177.27	3.40	67.93	0.09	28.08	0.30	-67.07	1.16	13.59
4.000	0.51	-179.59	3.31	66.28	0.09	27.96	0.29	-67.74	1.19	13.22

Note:

1. Gain Calculations:

$$MAG = \frac{|S_{21}|}{|S_{12}|} (K \pm \sqrt{K^2 - 1}). \text{ When } K \leq 1, \text{ MAG is undefined and MSG values are used. } MSG = \frac{|S_{21}|}{|S_{12}|}, K = \frac{1 + |\Delta|^2 - |S_{11}|^2 - |S_{22}|^2}{2 |S_{12} S_{21}|}, \Delta = S_{11} S_{22} - S_{21} S_{12}$$

MAG = Maximum Available Gain
MSG = Maximum Stable Gain

TYPICAL SCATTERING PARAMETERS (TA = 25°C)

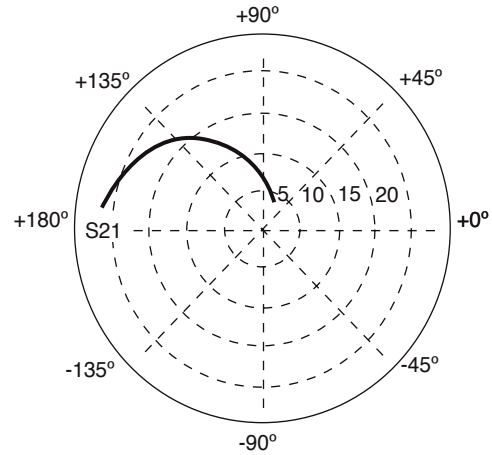
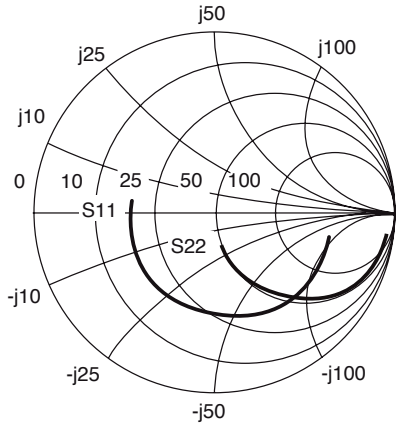

NE662M16
Vc = 2 V, Ic = 10 mA

FREQUENCY GHz	S11		S21		S12		S22		K	MAG ¹ (dB)
	MAG	ANG	MAG	ANG	MAG	ANG	MAG	ANG		
0.100	0.66	-12.81	21.08	170.08	0.01	81.45	0.96	-7.79	0.19	34.48
0.200	0.66	-28.48	20.34	161.46	0.01	76.90	0.94	-15.60	0.13	31.43
0.300	0.65	-41.93	19.32	153.18	0.02	70.56	0.90	-22.67	0.16	29.60
0.400	0.63	-53.87	18.18	145.93	0.03	65.20	0.85	-28.92	0.20	28.32
0.500	0.61	-64.70	16.97	139.38	0.03	60.63	0.80	-34.46	0.24	27.29
0.600	0.60	-74.41	15.75	133.63	0.04	56.67	0.75	-39.19	0.28	26.47
0.700	0.58	-82.86	14.65	128.64	0.04	53.54	0.70	-43.27	0.33	25.76
0.800	0.57	-90.61	13.62	124.38	0.04	50.71	0.66	-46.77	0.37	25.14
0.900	0.56	-97.18	12.70	120.59	0.04	48.39	0.62	-49.77	0.41	24.59
1.000	0.55	-103.22	11.88	117.23	0.05	46.60	0.58	-52.36	0.45	24.11
1.100	0.55	-108.53	11.17	114.18	0.05	45.17	0.55	-54.59	0.49	23.68
1.200	0.54	-113.37	10.51	111.31	0.05	43.92	0.52	-56.54	0.52	23.28
1.300	0.54	-117.69	9.95	108.65	0.05	42.92	0.50	-58.27	0.56	22.91
1.400	0.53	-121.63	9.43	106.24	0.05	42.14	0.47	-59.73	0.59	22.57
1.500	0.53	-125.35	8.96	103.96	0.05	41.39	0.45	-61.06	0.63	22.24
1.600	0.52	-128.85	8.50	101.70	0.05	40.83	0.43	-62.21	0.66	21.92
1.700	0.52	-132.25	8.13	99.47	0.06	40.51	0.42	-63.19	0.70	21.65
1.800	0.52	-135.50	7.82	97.63	0.06	40.23	0.40	-64.16	0.73	21.39
1.900	0.51	-138.46	7.48	96.05	0.06	39.88	0.38	-64.99	0.76	21.12
2.000	0.51	-141.58	7.14	94.06	0.06	39.77	0.37	-65.63	0.80	20.83
2.100	0.51	-144.72	6.89	92.12	0.06	39.58	0.36	-66.43	0.82	20.62
2.200	0.50	-147.54	6.66	90.21	0.06	39.38	0.35	-66.83	0.84	20.38
2.300	0.50	-150.41	6.44	88.94	0.06	39.49	0.34	-67.39	0.87	20.17
2.400	0.50	-153.04	6.17	87.15	0.06	39.53	0.33	-67.86	0.90	19.91
2.500	0.50	-155.65	5.98	85.19	0.06	39.40	0.32	-68.39	0.93	19.72
2.600	0.49	-158.30	5.80	83.57	0.07	39.29	0.31	-68.81	0.95	19.50
2.700	0.49	-160.91	5.61	82.16	0.07	39.33	0.30	-69.31	0.98	19.29
2.800	0.49	-163.29	5.40	80.62	0.07	39.31	0.29	-69.61	1.01	18.53
2.900	0.48	-165.82	5.24	78.93	0.07	39.52	0.28	-70.04	1.04	17.69
3.000	0.48	-168.40	5.09	77.50	0.07	39.41	0.27	-70.48	1.06	17.14
3.100	0.47	-171.02	4.93	76.12	0.07	39.56	0.27	-70.87	1.09	16.67
3.200	0.47	-173.52	4.78	74.60	0.07	39.47	0.26	-71.30	1.11	16.22
3.300	0.47	-175.90	4.66	73.12	0.07	39.46	0.25	-71.76	1.13	15.88
3.400	0.47	-178.39	4.53	71.93	0.07	39.49	0.24	-72.30	1.15	15.52
3.500	0.47	-179.16	4.39	70.55	0.07	39.50	0.24	-72.89	1.17	15.17
3.600	0.47	-176.86	4.27	69.00	0.08	39.45	0.23	-73.50	1.19	14.85
3.700	0.47	-174.73	4.18	67.66	0.08	39.36	0.22	-74.30	1.21	14.60
3.800	0.47	-172.77	4.06	66.70	0.08	39.24	0.22	-75.12	1.23	14.28
3.900	0.47	-170.80	3.93	65.49	0.08	39.22	0.21	-75.94	1.25	13.93
4.000	0.47	-168.82	3.83	63.99	0.08	39.15	0.20	-76.91	1.27	13.64

Note:

1. Gain Calculations:

$$MAG = \frac{|S_{21}|}{|S_{12}|} (K \pm \sqrt{K^2 - 1})$$

When $K \leq 1$, MAG is undefined and MSG values are used. $MSG = \frac{|S_{21}|}{|S_{12}|}$, $K = \frac{1 + |\Delta|^2 - |S_{11}|^2 - |S_{22}|^2}{2 |S_{12} S_{21}|}$, $\Delta = S_{11} S_{22} - S_{21} S_{12}$

MAG = Maximum Available Gain

MSG = Maximum Stable Gain

TYPICAL SCATTERING PARAMETERS (TA = 25°C)

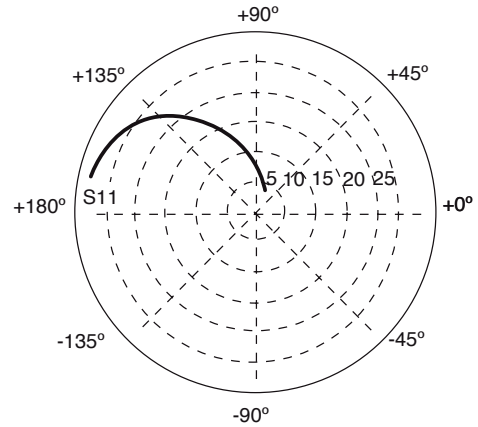
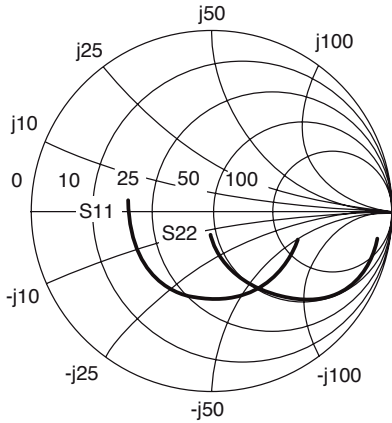

NE662M16

Vc = 2 V, Ic = 20 mA

FREQUENCY GHz	S11		S21		S12		S22		K	MAG ¹ (dB)
	MAG	ANG	MAG	ANG	MAG	ANG	MAG	ANG		
0.100	0.51	-19.24	28.64	168.38	0.01	79.10	0.94	-9.68	0.26	36.13
0.200	0.51	-39.58	27.18	157.71	0.01	74.03	0.90	-19.55	0.20	33.13
0.300	0.51	-56.67	25.27	148.17	0.02	67.79	0.85	-28.23	0.23	31.27
0.400	0.51	-71.47	23.19	140.08	0.02	62.44	0.79	-35.68	0.28	29.98
0.500	0.50	-83.85	21.13	133.18	0.03	58.17	0.72	-41.91	0.33	28.93
0.600	0.50	-94.44	19.22	127.33	0.03	54.93	0.66	-47.08	0.39	28.06
0.700	0.49	-103.20	17.57	122.40	0.03	52.50	0.61	-51.40	0.44	27.33
0.800	0.49	-110.77	16.11	118.27	0.03	50.56	0.56	-55.03	0.49	26.69
0.900	0.49	-117.07	14.85	114.65	0.04	49.13	0.52	-58.07	0.54	26.11
1.000	0.49	-122.58	13.76	111.47	0.04	48.10	0.49	-60.66	0.59	25.60
1.100	0.48	-127.34	12.83	108.63	0.04	47.35	0.46	-62.85	0.64	25.12
1.200	0.48	-131.56	11.98	105.97	0.04	46.96	0.43	-64.73	0.68	24.67
1.300	0.48	-135.30	11.27	103.49	0.04	46.65	0.41	-66.43	0.72	24.27
1.400	0.48	-138.62	10.62	101.28	0.04	46.44	0.39	-67.82	0.75	23.88
1.500	0.48	-141.83	10.04	99.19	0.04	46.48	0.37	-69.05	0.79	23.50
1.600	0.48	-144.87	9.49	97.12	0.05	46.28	0.35	-70.13	0.83	23.14
1.700	0.48	-147.80	9.04	95.06	0.05	46.44	0.33	-71.09	0.86	22.81
1.800	0.47	-150.55	8.66	93.37	0.05	46.55	0.32	-71.97	0.89	22.51
1.900	0.47	-153.08	8.25	91.95	0.05	46.81	0.31	-72.73	0.92	22.19
2.000	0.47	-155.81	7.86	90.10	0.05	46.88	0.29	-73.33	0.95	21.87
2.100	0.47	-158.52	7.56	88.29	0.05	46.96	0.28	-74.04	0.97	21.60
2.200	0.47	-161.02	7.29	86.54	0.05	47.15	0.27	-74.48	0.99	21.33
2.300	0.47	-163.41	7.03	85.38	0.05	47.44	0.26	-74.96	1.01	20.46
2.400	0.47	-165.69	6.72	83.75	0.06	47.56	0.26	-75.41	1.04	19.60
2.500	0.47	-167.97	6.50	81.93	0.06	47.55	0.25	-75.93	1.06	19.05
2.600	0.46	-170.37	6.29	80.42	0.06	47.65	0.24	-76.35	1.07	18.61
2.700	0.46	-172.58	6.07	79.19	0.06	47.79	0.23	-76.85	1.09	18.15
2.800	0.46	-174.73	5.84	77.76	0.06	47.81	0.22	-77.18	1.12	17.64
2.900	0.46	-177.01	5.65	76.22	0.06	47.96	0.21	-77.67	1.14	17.23
3.000	0.45	-179.36	5.49	74.88	0.06	47.89	0.21	-78.08	1.16	16.88
3.100	0.45	178.28	5.31	73.63	0.07	48.00	0.20	-78.62	1.17	16.51
3.200	0.45	176.08	5.14	72.22	0.07	47.97	0.19	-79.11	1.19	16.16
3.300	0.45	173.87	5.00	70.83	0.07	47.81	0.19	-79.69	1.20	15.87
3.400	0.45	171.68	4.86	69.75	0.07	47.81	0.18	-80.42	1.22	15.56
3.500	0.45	169.53	4.71	68.47	0.07	47.78	0.18	-81.20	1.23	15.26
3.600	0.46	167.47	4.58	67.03	0.07	47.68	0.17	-82.06	1.24	14.97
3.700	0.46	165.67	4.47	65.80	0.07	47.46	0.16	-83.19	1.25	14.74
3.800	0.46	163.96	4.34	64.93	0.08	47.30	0.16	-84.30	1.27	14.44
3.900	0.46	162.28	4.21	63.80	0.08	47.24	0.15	-85.66	1.29	14.12
4.000	0.46	160.56	4.09	62.37	0.08	46.96	0.15	-87.01	1.30	13.86

Note:

1. Gain Calculations:

$$MAG = \frac{|S_{21}|}{|S_{12}|} (K \pm \sqrt{K^2 - 1}). \text{ When } K \leq 1, \text{ MAG is undefined and MSG values are used. } MSG = \frac{|S_{21}|}{|S_{12}|}, K = \frac{1 + |\Delta|^2 - |S_{11}|^2 - |S_{22}|^2}{2 |S_{12} S_{21}|}, \Delta = S_{11} S_{22} - S_{21} S_{12}$$

MAG = Maximum Available Gain

MSG = Maximum Stable Gain

NE662M16 NONLINEAR MODEL

SCHEMATIC

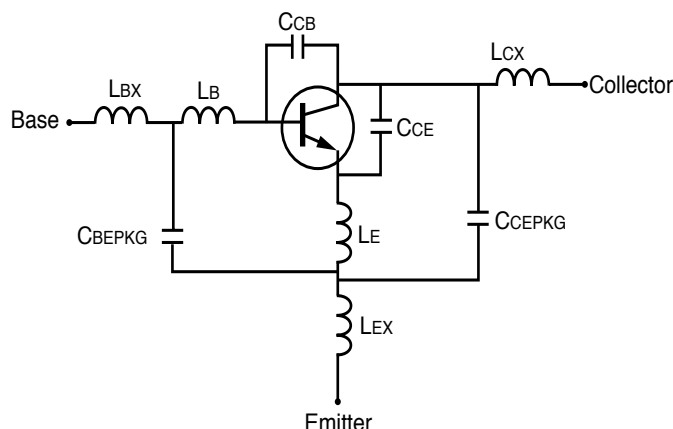
BJT NONLINEAR MODEL PARAMETERS ⁽¹⁾

Parameters	Q1	Parameters	Q1
IS	1.6e-16	MJC	0.3
BF	105	XCJC	0.1
NF	1.02	CJS	0
VAF	23	VJS	0.75
IKF	0.38	MJS	0
ISE	1e-6	FC	0.6
NE	30	TF	2e-12
BR	12	XTF	0.2
NR	1.02	VTF	0.2
VAR	2.5	ITF	0.03
IKR	0.1	PTF	0
ISC	3e-15	TR	1e-11
NC	1.28	EG	1.11
RE	1.1	XTB	0
RB	6	XTI	3
RBM	3.5	KF	0
IRB	1.3e-3	AF	1
RC	8.75		
CJE	0.4e-12		
VJE	0.6		
MJE	0.5		
CJC	0.1e-12		
VJC	0.75		

(1) Gummel-Poon Model

ADDITIONAL PARAMETERS

Parameters	NE662M16
CCB	0.07e-12
CCE	0.09e-12
LB	0.4e-9
LE	0.14e-9
CCEPKG	0.12e-12
CBEPK	0.1e-12
LBX	0.1e-9
LCX	0.6e-9
LEX	0.04e-9

MODEL RANGE

Frequency: 0.1 to 4 GHz
 Bias: $V_{CE} = 0.5 \text{ V to } 3 \text{ V}$, $I_C = 1 \text{ mA to } 30 \text{ mA}$
 Date: 01/15/2002

Life Support Applications

These NEC products are not intended for use in life support devices, appliances, or systems where the malfunction of these products can reasonably be expected to result in personal injury. The customers of CEL using or selling these products for use in such applications do so at their own risk and agree to fully indemnify CEL for all damages resulting from such improper use or sale.

EXCLUSIVE NORTH AMERICAN AGENT FOR NEC RF, MICROWAVE & OPTOELECTRONIC SEMICONDUCTORS

CEL CALIFORNIA EASTERN LABORATORIES • Headquarters • 4590 Patrick Henry Drive • Santa Clara, CA 95054-1817 • (408) 988-3500 • Telex 34-6393 • FAX (408) 988-0279
 DATA SUBJECT TO CHANGE WITHOUT NOTICE

Internet: <http://WWW.CEL.COM>

01/22/2002

Subject: Compliance with EU Directives

CEL certifies, to its knowledge, that semiconductor and laser products detailed below are compliant with the requirements of European Union (EU) Directive 2002/95/EC Restriction on Use of Hazardous Substances in electrical and electronic equipment (RoHS) and the requirements of EU Directive 2003/11/EC Restriction on Penta and Octa BDE.

CEL Pb-free products have the same base part number with a suffix added. The suffix –A indicates that the device is Pb-free. The –AZ suffix is used to designate devices containing Pb which are exempted from the requirement of RoHS directive (*). In all cases the devices have Pb-free terminals. All devices with these suffixes meet the requirements of the RoHS directive.

This status is based on CEL’s understanding of the EU Directives and knowledge of the materials that go into its products as of the date of disclosure of this information.

Restricted Substance per RoHS	Concentration Limit per RoHS (values are not yet fixed)	Concentration contained in CEL devices	
		-A	-AZ
Lead (Pb)	< 1000 PPM	Not Detected	(*)
Mercury	< 1000 PPM	Not Detected	
Cadmium	< 100 PPM	Not Detected	
Hexavalent Chromium	< 1000 PPM	Not Detected	
PBB	< 1000 PPM	Not Detected	
PBDE	< 1000 PPM	Not Detected	

If you should have any additional questions regarding our devices and compliance to environmental standards, please do not hesitate to contact your local representative.

Important Information and Disclaimer: Information provided by CEL on its website or in other communications concerning the substance content of its products represents knowledge and belief as of the date that it is provided. CEL bases its knowledge and belief on information provided by third parties and makes no representation or warranty as to the accuracy of such information. Efforts are underway to better integrate information from third parties. CEL has taken and continues to take reasonable steps to provide representative and accurate information but may not have conducted destructive testing or chemical analysis on incoming materials and chemicals. CEL and CEL suppliers consider certain information to be proprietary, and thus CAS numbers and other limited information may not be available for release.

In no event shall CEL’s liability arising out of such information exceed the total purchase price of the CEL part(s) at issue sold by CEL to customer on an annual basis.

See CEL Terms and Conditions for additional clarification of warranties and liability.