

DATA SHEET

NE1617A

Temperature monitor for
microprocessor systems

Product data sheet
Supersedes data of 2001 Dec 14

2004 Oct 05

Temperature monitor for microprocessor systems

NE1617A

FEATURES

- Replacement for Maxim MAX1617 and Analog Devices ADM1021
- Monitors local and remote temperature
- Accuracy

	60 °C to 100 °C	0 °C to 125 °C
local (on-chip) sensor	±2 °C	±3 °C
remote sensor	±3 °C	±5 °C

- No calibration required
- Programmable over/under temperature alarm
- SMBus 2-wire serial interface up to 100 kHz
- 3 V to 5.5 V supply range; 5.5 V tolerant
- 70 µA supply current in operating mode
- 3 µA (typical) supply current in standby mode
- ESD protection exceeds 2000 V HBM per JESD22-A114, 250 V MM per JESD22-A115, and 1000 V CDM per JESD22-C101
- Latch-up testing is done to JEDEC standard JESD78, which exceeds 100 mA
- Small 16-lead SSOP (QSOP) package

APPLICATIONS

- Desktop computers
- Notebook computers
- Smart battery packs
- Industrial controllers
- Telecom equipment

DESCRIPTION

The NE1617A is an accurate two-channel temperature monitor. It measures the temperature of itself and the temperature of a remote sensor. The remote sensor is a diode connected transistor. This can be in the form of either a discrete NPN/PNP, such as the 2N3904/2N3906, or a diode connected PNP built into another die, such as is done on some INTEL microprocessors.

The temperature of both the remote and local sensors is stored in a register that can be read via a 2-wire SMBus. The temperatures are updated at a rate that is programmable via the SMBus (the average supply current is dependent upon the update rate—the faster the rate, the higher the current).

In addition to the normal operation, which is to update the temperature at the programmed rate, there is a one shot mode that will force a temperature update.

There is also an alarm that senses either an over or under temperature condition. The trip points for this alarm are also programmable.

The device can have 1 of 9 addresses (determined by 2 address pins), so there can be up to 9 of the NE1617A on the SMBus.

It can also be put in a standby mode (in order to save power). This can be done either with software (over the SMBus) or with hardware (using the STBY pin).

PIN CONFIGURATION

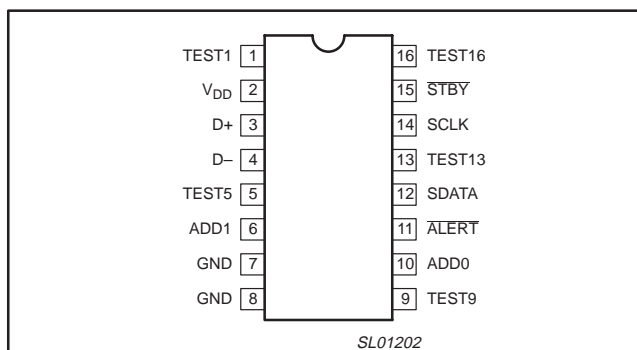

Figure 1. Pin configuration.

PIN DESCRIPTION

PIN	SYMBOL	DESCRIPTION/COMMENTS
1	TEST1	Factory use only ¹
2	V _{DD}	Positive supply ²
3	D+	Positive side of remote sensor
4	D-	Negative side of remote sensor
5	TEST5	Factory use only ¹
6	ADD1	Device address pin (3-State)
7	GND	Ground
8	GND	Ground
9	TEST9	Factory use only ¹
10	ADD0	Device address pin (3-State)
11	ALERT	Open drain output used as interrupt or SMBus alert
12	SDATA	SMBus serial data input/output open drain
13	TEST13	Factory use only ¹
14	SCLK	SMBus clock input
15	STBY	Hardware standby input pin HIGH = normal operating mode LOW = standby mode
16	TEST16	Factory use only ¹

NOTES:

1. These pins should either float or be tied to ground.
2. V_{DD} pin should be decoupled by a 0.1 µF capacitor.

Temperature monitor for microprocessor systems

NE1617A

ORDERING INFORMATION

$T_{amb} = 0^{\circ}\text{C to } +125^{\circ}\text{C}$

Type number	Topside mark	Package		Version
		Name	Description	
NE1617ADS	NE1617A	SSOP16 (QSOP16)	plastic shrink small outline package; 16 leads; body width 3.9 mm; lead pitch 0.635 mm	SOT519-1

FUNCTIONAL BLOCK DIAGRAM

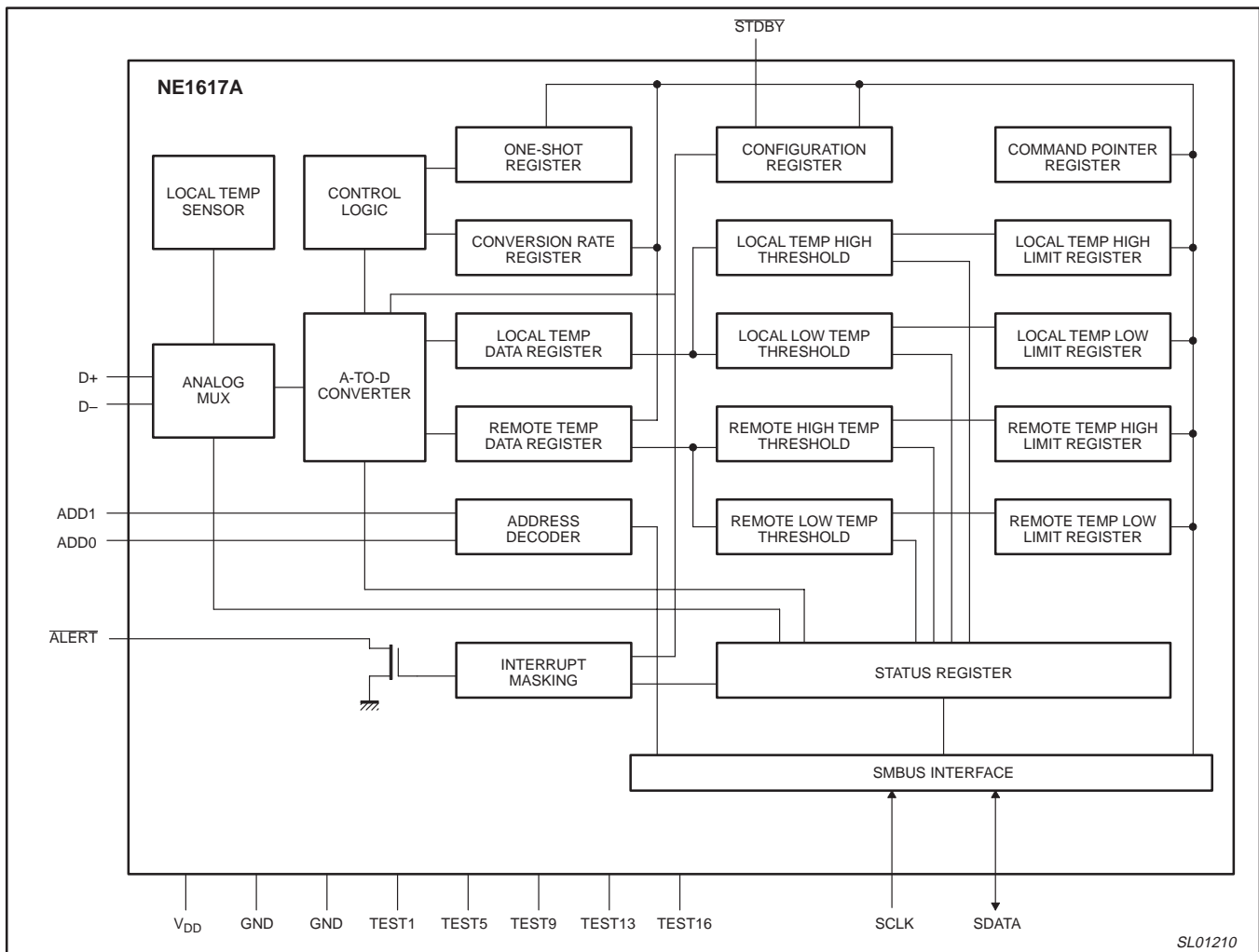
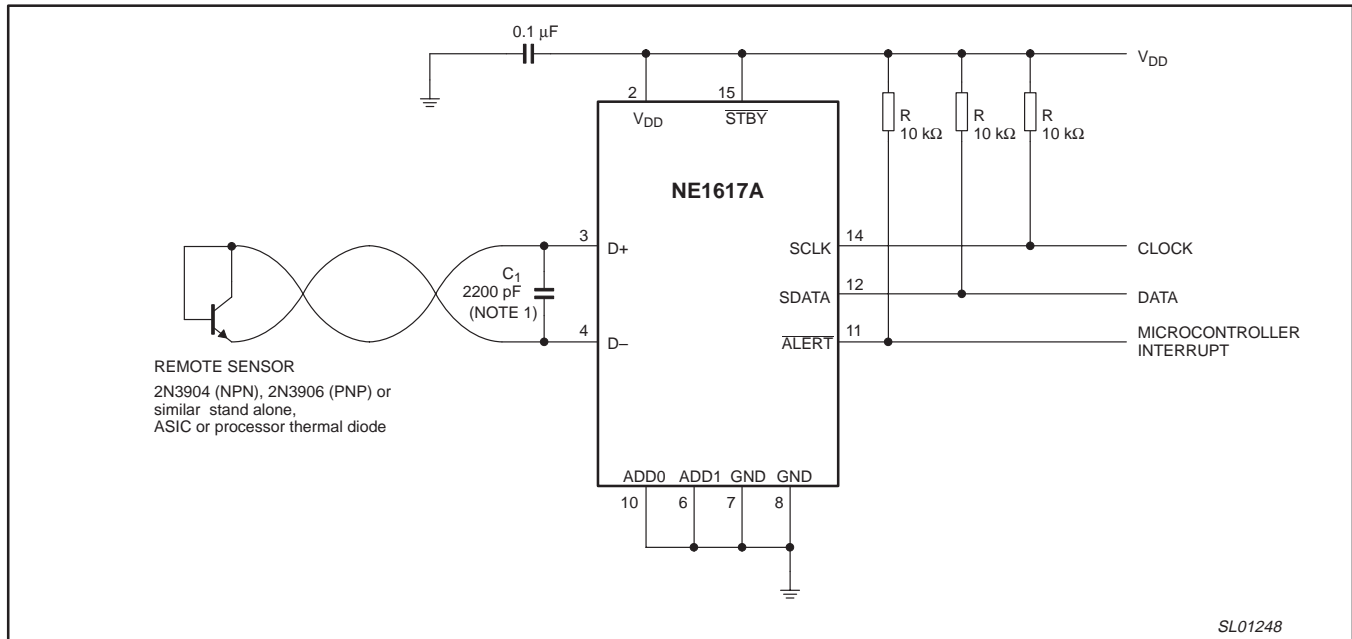

Figure 2. Functional block diagram.

Temperature monitor for microprocessor systems

NE1617A

TYPICAL APPLICATION CIRCUIT



NOTES:

1. Typical value, placed close to temperature sensor.

Figure 3. Typical application circuit.

ABSOLUTE MAXIMUM RATINGS

PARAMETER	MIN.	MAX.	UNIT
V _{DD} to GND	-0.3	+6	V
D+, ADD0, ADD1	-0.3	V _{DD} +0.3	V
D- to GND	-0.3	+0.8	V
SCLK, SDATA, ALERT, STBY	-0.3	+6	V
Input current SDATA	-1	+50	mA
D- current		±1	mA
Operating temperature range	0	+125	°C
Maximum junction temperature		+150	°C
Storage temperature range	-65	+150	°C

Temperature monitor for microprocessor systems

NE1617A

ELECTRICAL CHARACTERISTICS $V_{DD} = 3.0 \text{ V to } 3.6 \text{ V}$; $T_{amb} = 0 \text{ }^\circ\text{C to } +125 \text{ }^\circ\text{C}$, unless otherwise noted.

PARAMETER	CONDITIONS	LIMITS			UNIT
		MIN.	TYP.	MAX.	
Temperature resolution		1			$^\circ\text{C}$
Local temperature error	$T_{amb} = +60 \text{ }^\circ\text{C to } +100 \text{ }^\circ\text{C}$		$< \pm 1$	± 2	$^\circ\text{C}$
	$T_{amb} = 0 \text{ }^\circ\text{C to } +125 \text{ }^\circ\text{C}$		$< \pm 2$	± 3	$^\circ\text{C}$
Remote temperature error	$T_{remote} = +60 \text{ }^\circ\text{C to } +100 \text{ }^\circ\text{C}$			± 3	$^\circ\text{C}$
	$T_{remote} = 0 \text{ }^\circ\text{C to } +125 \text{ }^\circ\text{C}$			± 5	$^\circ\text{C}$
Under voltage lockout ¹	V_{DD} supply (Note 2)		2.7	2.95	V
Power-on reset threshold	V_{DD} supply (falling edge) (Note 3)	1.0		2.5	V
Power supply current (average)	Conversion rate = 0.25/sec			70	μA
	Conversion rate = 2/sec			180	μA
Power supply current (standby)	SMBus inactive		3	10	μA
Conversion time	From stop bit to conversion complete, both channels			170	ms
Conversion rate error	Percentage error in programmed rate	-30		+30	%
Remote sensor source current	HIGH level		100		μA
	LOW level		10		μA
Address pin bias current	Momentary as the address is being read (Notes 4 and 5)		160		μA

NOTES:

- Definition of Under Voltage Lockout (UVL): The value of V_{DD} below which the internal A/D converter is disabled. This is designed to be a minimum of 200 mV above the power-on reset. During the time that it is disabled, the temperature that is in the "read temperature registers" will remain at the value that it was before the A/D was disabled. This is done to eliminate the possibility of reading unexpected false temperatures due to the A/D converter not working correctly due to low voltage. In case of power-up (rising V_{DD}), the reading that is stored in the "read temperature registers" will be the default value of 0 $^\circ\text{C}$. As soon as V_{DD} has risen to the value of UVL, the A/D will function correctly and normal temperatures will be read.
- V_{DD} (rising edge) voltage below which the ADC is disabled.
- V_{DD} (falling edge) voltage below which the logic is reset.
- Address is read a power up and at start of conversion for all conversions except the fastest rate.
- Due to the bias current, any pull-up/down resistors should be $\leq 2 \text{ k}\Omega$.

Temperature monitor for microprocessor systems

NE1617A

SMBus INTERFACE AC SPECIFICATIONS¹

$V_{DD} = 3.0\text{ V to }3.6\text{ V}^2$; $T_{amb} = 0\text{ }^{\circ}\text{C to }+125\text{ }^{\circ}\text{C}$ unless otherwise noted.
 These specifications are guaranteed by design and not tested in production.

SYMBOL	PARAMETER	CONDITIONS	MIN	TYP	MAX	UNIT
V_{IH}	Logic input high voltage for STBY, SCLK, SDATA	$V_{DD} = 3\text{ V to }5.5\text{ V}$	2.2			V
V_{IL}	Logic input low voltage for STBY, SCLK, SDATA	$V_{DD} = 3\text{ V to }5.5\text{ V}$			0.8	V
I_{OL}	Logic output low sink current for ALERT SDATA	$V_{OL} = 0.4\text{ V}$ $V_{OL} = 0.6\text{ V}$	1.0 6.0			mA mA
I_{IH} & I_{IL}	Logic input current	$V_{IN} = V_{DD}$ or GND	-1.0		1.0	μA
C_{IN}	SMBus input capacitance for SCLK,SDATA			5		pF
f_{SCLK}	SCLK operating frequency	See Figure 4	0		100	kHz
t_{LOW}	SCLK low time	See Figure 4	4.7	5.0		μs
t_{HIGH}	SCLK high time	See Figure 4	4.0	5.0		μs
t_{BUF}	SMBus free time. Delay from SDA stop to SDA start	See Figure 4	4.7			μs
$t_{HD:STA}$	Hold time of start condition. Delay from SDA start to first SCL H-L	See Figure 4	4.0			μs
$t_{HD:DAT}$	Hold time of data. Delay from SCL H-L to SDA edges	See Figure 4	0			ns
$t_{SU:DAT}$	Set-up time of data. Delay from SDA edges to SCL L-H	See Figure 4	250			ns
$t_{SU:STA}$	Set-up time of repeat start condition. Delay from SCL L-H to restart SDA	See Figure 4	250			ns
$t_{SU:STO}$	Set-up time of stop condition. Delay from SCL L-H to SDA stop	See Figure 4	4.0			μs
t_F	Fall time of SCL and SDA	See Figure 4			1.0	μs

NOTES:

1. The NE1617A does not include the SMBus timeout capability ($t_{LOW:SEXT}$ and $t_{LOW:MEXT}$).
2. Device operation between 3.0 V to 5.5 V is allowed, but parameters may be outside the limit shown in table.

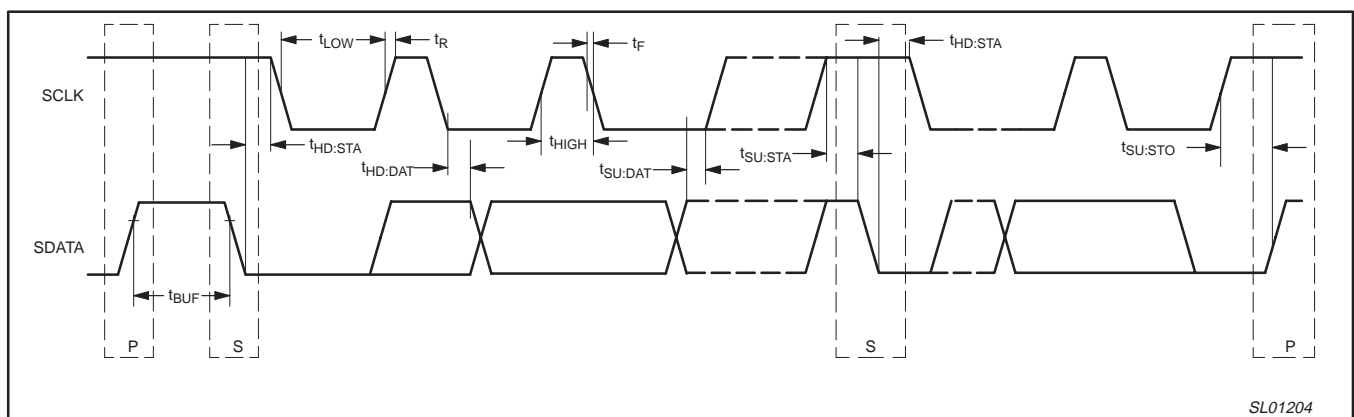

Figure 4. Timing measurements.

Temperature monitor for microprocessor systems

NE1617A

TYPICAL PERFORMANCE CHARACTERISTICS

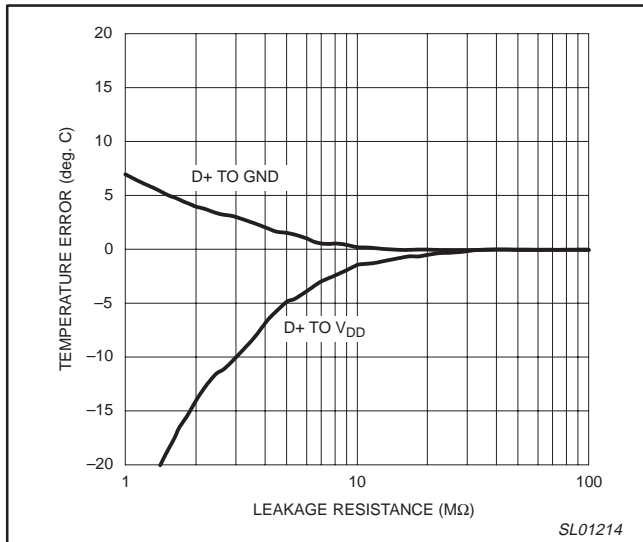

Figure 5. Temperature error vs. PC board leakage resistance

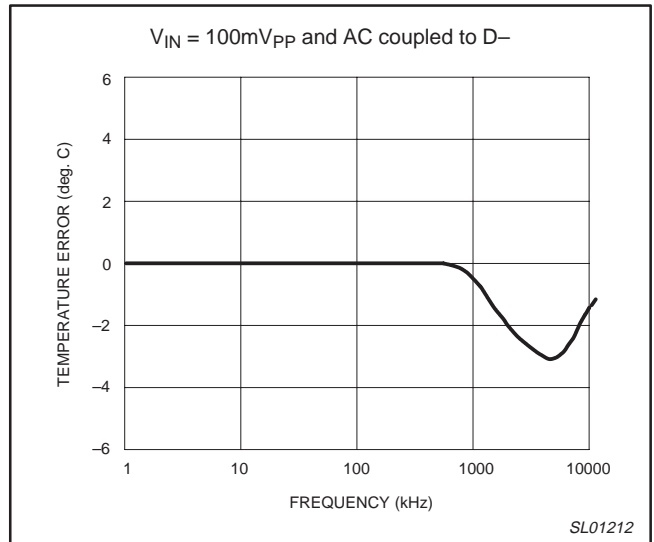

Figure 6. Temperature error vs. common_mode noise frequency

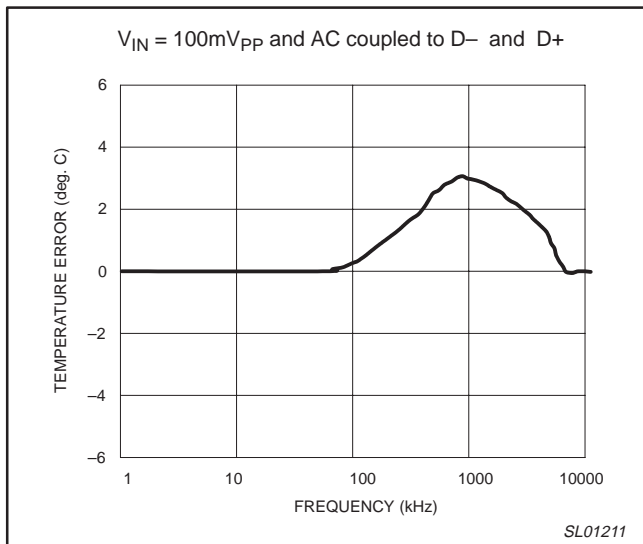

Figure 7. Temperature error vs. differential mode noise frequency

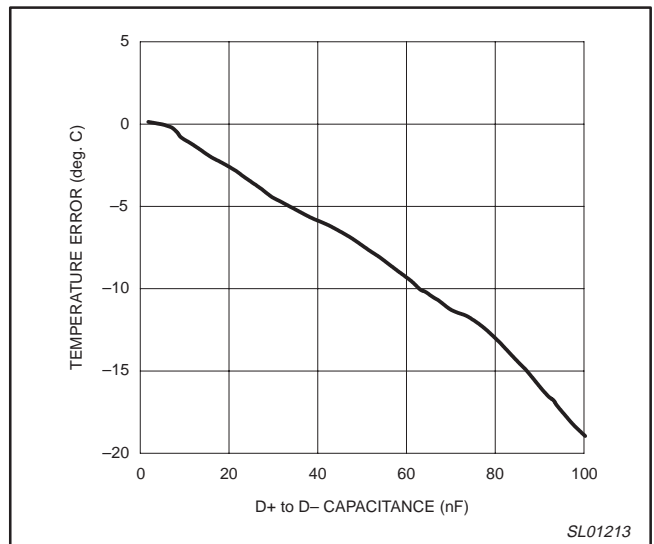

Figure 8. Temperature error vs. D+to D- capacitance

Temperature monitor for microprocessor systems

NE1617A

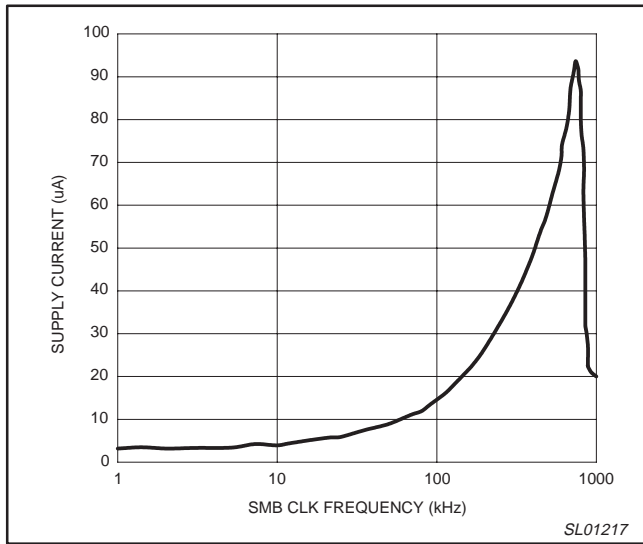

Figure 9. Standby supply current vs. clock frequency @ $V_{CC} = 3.3\text{ V}$

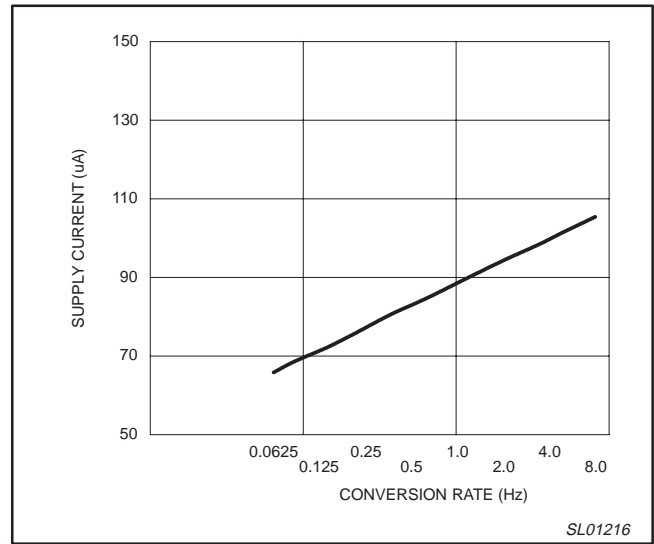

Figure 10. Operating supply current vs. conversion rate @ $V_{CC} = 3.3\text{ V}$

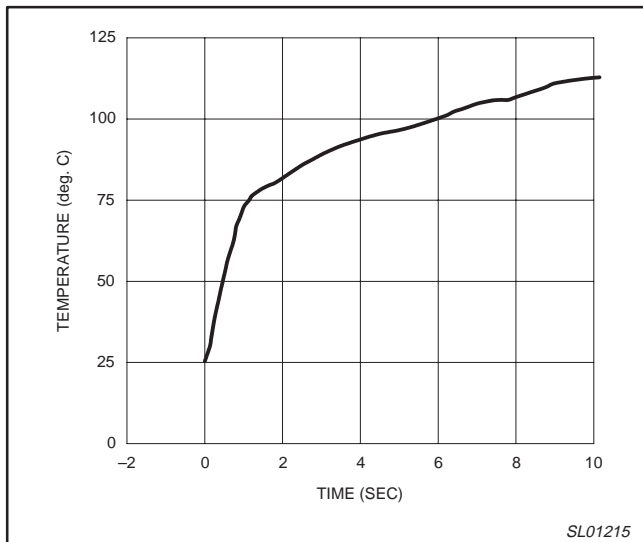

Figure 11. Response to thermal shock immersed in +115 °C fluorinert bath

Temperature monitor for microprocessor systems

NE1617A

FUNCTIONAL DESCRIPTION

The NE1617A contains an integrating A-to-D converter, an analog multiplexer, a status register, digital data registers, SMBus interface, associated control logic and a local temperature sensor or channel. The remote diode-type sensor or channel should be connected to the D+ and D– pins properly.

Temperature measurements or conversions are either automatically and periodically activated when the device is in free-running mode (both \overline{STBY} pin = HIGH, and the configuration register BIT6 = LOW) or generated by one-shot command. The free-running period is selected by changing the programmable data of the conversion rate register as described later. For each conversion, the multiplexer switches current sources through the remote and local temperature sensors over a period of time, about 60 ms, and the voltages across the diode-type sensors are sensed and converted into the temperature data by the A-to-D converter. The resulting temperature data is then stored in the temperature registers, in 8-bit, two's complement word format and automatically compared with the limits which have been programmed in the temperature limit registers. Results of the comparison are reflected accordingly by the flags stored in the status register, an out-of-limit condition will set the \overline{ALERT} output pin to its LOW state. Because both channels are automatically measured for each conversion, the results are updated for both channels at the end of every successful conversion.

Remote diode selection

The method of the temperature measurement is based on the change of the diode VBE at two different operating current levels given by:

$$\Delta V_{BE} = \frac{KT}{q} * \ln(N)$$

where:

ΔV_{BE} = change in base emitter voltage drop at two current levels

K: Boltzman's constant

T: absolute temperature in ° Kelvin

q: charge on the electron

N: ratio of the two currents

LN: natural logarithm

The NE1617A forces two well-controlled current sources of about 10 μ A and 100 μ A and measures the remote diode VBE. The sensed voltage between two pins D+ and D– is limited between 0.25 V and 0.95 V. The external diode must be selected to meet this voltage range at these two current levels. The diode-connected PNP transistor provided on the microprocessor is typically used, or the discrete diode-connected transistor 2N3904 or 2N3906 is recommended as an alternative.

Even though the NE1617A integrating A-to-D converter has a good noise performance, using the average of 10 measurement cycles, high frequency noise filtering between D+ and D– should be considered. An external capacitor of 2200 pF typical (but not higher than 3300 pF) connected between D+ and D– is recommended. Capacitance higher than 3300 pF will introduce measurement error due to the rise time of the switched current source.

No calibration is required

As mentioned in the 'Remote diode selection' section, the NE1617A uses two well-controlled current sources of 10:1 ratio to measure the forward voltage of the diode (VBE). This technique eliminates the diode saturation current, I_S (a heavily process and temperature dependent variable) and results in the forward voltage being proportional to absolute temperature.

Address logic

The address pins of the NE1617A can be forced into one of three levels: LOW (GND), HIGH (V_{DD}), or Not Connected (NC). Because the NE1617A samples and latches the address pins at the starting of every conversion, it is suggested that those address pins should be hard-wired to the logic applied, so that the logic is consistently existed at the address pins. During the address sensing period, the device forces a current at each address pin and compares the voltage developed across the external connection with the predefined threshold voltage in order to define the logic level. If an external resistor is used for the connection of the address, then its value should be less than 2 k Ω to prevent the error in logic detection from happening. Resistors of 1 k Ω are recommended.

Temperature monitor for microprocessor systems

NE1617A

TEMPERATURE MONITOR WITH SMB SERIAL INTERFACE**Serial bus interface**

The device can be connected to a standard 2-wire serial interface System Management Bus (SMBus) as a slave device under the control of a master device, using two device terminals SCLK and SDATA. The operation of the device to the bus is described with details in the following sections.

Slave address

The device address is defined by the logical connections applied to the device pins ADD0 and ADD1. A list of selectable addresses are shown in Table 1. The device address can be set to any one of those nine combinations and more than one device can reside on the same bus without address conflict. Note that the state of the device address pins is sampled and latched not only at power-up step but also at starting point of every conversion.

Table 1. Device slave address

ADD0*	ADD1*	ADDRESS BYTE
GND	GND	0011 000
GND	NC	0011 001
GND	V _{DD}	0011 010
NC	GND	0101 001
NC	NC	0101 010
NC	V _{DD}	0101 011
V _{DD}	GND	1001 100
V _{DD}	NC	1001 101
V _{DD}	V _{DD}	1001 110

NC = Not Connected.

* Any pull-up/down resistor used to connect to GND or V_{DD} should be ≤ 2 k Ω .

Registers

The device contains more than 9 registers. They are used to store the data of device setup and operation results. Depending on the bus communication (either read or write operations), each register may be called by different names because each register may have different sub-addresses or commands for read and write operations. For example, the configuration register is called as WC for write mode and as RC for read mode. Table 2 (Register Assignments) shows the names, commands and functions of all registers as well as the register POR states.

Note that attempting to write to a read-command or read from a write-command will produce an invalid result. The reserved registers are used for factory test purposes and should not be written to.

Low power standby modes

Upon POR, the device is reset to its normal free-running auto-conversion operation mode. The device can be put into standby mode by either using hardware control (connect the $\overline{\text{STBY}}$ pin to LOW for hardware standby mode) or using software control (set bit 6 of the configuration register to HIGH for software standby mode). When the device is put in either one of the standby modes, the supply current is reduced to less than 10 μA if there is no SMBus activity, all data in the device registers are retained and the SMBus interface is still alive to bus communication. However, there is a difference in the device ADC conversion operation between hardware standby and software standby modes. In hardware standby mode, the device conversion is inhibited and the one-shot command does not initiate a conversion. In software standby mode, the one-shot command will initiate a conversion for both internal and external channels.

If a hardware standby command is received when the device is in normal mode and a conversion is in progress, the conversion cycle will stop and data in reading temperature registers will not be updated.

Table 2. Register assignments

REGISTER NAME	COMMAND BYTE	POR STATE	FUNCTION
RIT	00h	0000 0000	Read internal or local temp byte
RET	01h	0000 0000	Read external or remote temp byte
RS	02h	n/a	Read status byte
RC	03h	0000 0000	Read configuration byte
RCR	04h	0000 0010	Read conversion rate byte
RIHL	05h	0111 1111	Read internal temp HIGH limit byte
RILL	06h	1100 1001	Read internal temp LOW limit byte
REHL	07h	0111 1111	Read external temp HIGH limit byte
RELL	08h	1100 1001	Read external temp LOW limit byte
WC	09h	n/a	Write configuration byte
WCR	0Ah	n/a	Write conversion rate byte
WIHL	0Bh	n/a	Write internal temp HIGH limit byte
WILL	0Ch	n/a	Write internal temp LOW limit byte
WEHL	0Dh	n/a	Write external temp HIGH limit byte
WELL	0Eh	n/a	Write external temp LOW limit byte
OSHT	0Fh	n/a	One shot command
RESERVED	10h	n/a	Reserved
RESERVED	11h	n/a	Reserved
RESERVED	12h	n/a	Reserved
RESERVED	13h	n/a	Reserved

Temperature monitor for microprocessor systems

NE1617A

Configuration register

The configuration register is used to mask the Alert interrupt and/or to put the device in software standby mode. Only two bits 6 and 7 of this register are used as listed in Table 3. Bit 7 is used to mask the device ALERT output from Alert interruption when this bit is set to 1 and bit 6 is used to activate the standby software mode when this bit is set to 1.

This register can be written or read using the commands of registers named WC and RC accordingly. Upon Power-On Reset (POR), both bits are reset to zero.

Table 3. Configuration register bit assignments

BIT	NAME	POR STATE	FUNCTION
7 (MSB)	MASK	0	Mask ALERT interrupt: Interrupt is enabled when this bit is LOW, and disabled when this bit is HIGH.
6	RUN/STOP	0	Standby or run mode control: When LOW, running mode is enabled. When HIGH, standby mode is initiated.
5 to 0	RESERVED	n/a	n/a

External and internal temperature registers

Results of temperature measurements after every ADC conversion are stored in two registers: Internal Temp register (RIT) for internal or local diode temperature, and External Temp register (RET) for external or remote diode temperature. These registers can be only read over the SMBus. The reading temperature data is in 2's complement binary form consisting of 7-bit data and 1-bit sign (MSB), with each data count represents 1 °C, and the MSB bit is transmitted first over the serial bus. The contents of those two registers are updated upon completion of each ADC conversion. Table 4 shows some values of the temperature and data.

Table 4. Temperature data format (2's complement)

TEMPERATURE (°C)	DIGITAL OUTPUT (8 BITS)
+127	0 111 1111
+126	0 111 1110
+100	0 110 0100
+50	0 011 0010
+25	0 001 1001
+1	0 000 0001
0	0 000 0000
-1	1 111 1111
-25	1 110 0111
-50	1 100 1110
-65	1 011 1111

Conversion rate register

The conversion rate register is used to store programmable conversion data, which defines the time interval between conversions in standard free-running auto-convert mode. The Table 5 shows all applicable data and rates for the device. Only three LSB bits of the register are used and other bits are reserved for future use. This register can be written to and read back over the SMBus using commands of the registers named WCR and RCR respectively. The POR default conversion data is 02h (0.25Hz).

Notice that the average supply current, as well as the device power consumption, is increased with the conversion rate.

Table 5. Conversion rate control byte

DATA	CONVERSION RATE (Hz)	AVERAGE SUPPLY CURRENT (µA Typ. @ V _{DD} = 3.3 V)
00h	0.0625	TBD
01h	0.125	TBD
02h	0.25	TBD
03h	0.5	TBD
04h	1	TBD
05h	2	TBD
06h	4	TBD
07h	8	TBD
08h to FFh	Reserved	n/a

Temperature limit registers

The device has four registers to be used for storing programmable temperature limits, including the high limit and the low limit for each channel of the external and internal diodes. Data of the temperature register (RIT & RET) for each channel are compared with the contents of the temperature limit registers of the same channel, resulting in alarm conditions. If measured temperature either equals or exceeds the corresponding temperature limits, an Alert interrupt is asserted and the corresponding flag bit in the status register is set. The temperature limit registers can be written to and read back using commands of registers named WIHL, WILL, WEHL, WELL, RIHL, RILL, REHL, RELL accordingly. The POR default values are +127 °C (0111 1111) for the HIGH limit and -55 °C (1100 1001) for the LOW limit.

One-shot command

The one shot command is not actually a data register as such and a write operation to it will initiate an ADC conversion. The send byte format of the SMBus, as described later, with the use of OSHT command (0Fh), is used for this writing operation. In normal free-running-conversion operation mode of the device, a one-shot command immediately forces a new conversion cycle to begin. However, if a conversion is in progress when a one-shot command is received, the command is ignored. In software standby mode, the one-shot command generates a single conversion and comparison cycle and then puts the device back in its standby mode after the conversion. In hardware standby mode, the one shot is inhibited.

Temperature monitor for microprocessor systems

NE1617A

Status register

The content of the status register reflects condition status resulting from all of these activities: comparisons between temperature measurements and temperature limits, the status of ADC conversion, and the hardware condition of the connection of external diode to the device. Bit assignments and bit functions of this register are listed in Table 6. This register can only be read using the command of register named RS. Upon POR, the status of all flag bits are reset to zero. The status byte is cleared by any successful read of the status register unless the fault condition persists.

Notice that any one of the fault-conditions, except the conversion busy, also introduces an Alert interrupt to the SMBus that will be described in the following section. Also, whenever a one-shot command is executed, the status byte should be read after the conversion is completed, which is about 170 ms after the one-shot command is sent.

Table 6. Status register bit assignment

BIT	NAME	POR STATE	FUNCTION
7 (MSB)	BUSY	n/a	High when the ADC is busy converting
6	IHLF*	0	High when the internal temperature high limit has tripped
5	ILLF*	0	High when the internal temperature low limit has tripped
4	EHLF*	0	High when the external temperature high limit has tripped
3	ELLF*	0	High when the external temperature low limit has tripped
2	OPEN*	0	High when the external diode is opened
1 to 0	n/a	0	Reserved

* These flags stay high until the status register is read or POR is activated.

Alert interrupt

The $\overline{\text{ALERT}}$ output is used to signal Alert interruption from the device to the SMBus and is Active-LOW. Because this output is an open-drain output, a pull-up resistor (10 k Ω typ.) to V_{DD} is required, and slave devices can share a common interrupt line on the same SMBus. An Alert interrupt is asserted by the device whenever any one of the fault conditions, as described in the Status register section, occurs: measured temperature equals or exceeds corresponding temp limits, the remote diode is physically disconnected from the device pins. Alert interrupt signal is latched and can only be cleared by reading the Alert Response byte from the Alert Response Address which is a special slave address to the SMBus. The $\overline{\text{ALERT}}$ output can not be reset by reading the device status register. The device was designed to accommodate the Alert interrupt detection capability of the SMBus.¹

Basically, the SMBus provides Alert response interrupt pointers in order to identify the slave device which has caused the Alert interrupt. The 7-bit Alert response slave address is 0001 100 and the Alert response byte reflects the slave address of the device which has caused Alert interrupt. Bit assignments of the Alert response byte are listed in Table 7. The $\overline{\text{ALERT}}$ output will be reset to HIGH state upon reading the Alert response slave address unless the fault condition persists.

Table 7. Alert response bit assignment (Alert response address = 0001 100)

ALERT RESPONSE BIT	NAME ADDRESS BIT	FUNCTION
7 (MSB)	ADD7	Indicate address B6 of alerted device
6	ADD6	Indicate address B5 of alerted device
5	ADD5	Indicate address B4 of alerted device
4	ADD4	Indicate address B3 of alerted device
3	ADD3	Indicate address B2 of alerted device
2	ADD2	Indicate address B1 of alerted device
1	ADD1	Indicate address B0 of alerted device
0 (LSB)	1	Logic 1

1. The NE1617A implements the collision arbitration function per System Management Bus Specification Revision 1.1 dated December 11, 1998, which conforms to standard I²C arbitration as described in Philips Semiconductors document #98-8080-575-01.

Temperature monitor for microprocessor systems

NE1617A

Power-up default condition

Upon power-up reset (power is switched off-on), the NE1617A goes into this default condition:

- Interrupt latch is cleared, the $\overline{\text{ALERT}}$ output is pulled HIGH by the external pull-up resistor.
- The auto-conversion rate is at 0.25 Hz; conversion rate data is 02H.
- Temperature limits for both channels are +127 °C for high limit, and –55 °C for low limit.
- Command pointer register is set to 00 for quickly reading the RIT.

Fault detection

The NE1617A has a fault detector to the diode connection. The connection is checked when a conversion is initiated and the proper flags are set if the fault condition has occurred.

D+ & D–	ALERT OUTPUT	RET DATA STORAGE	STATUS SET FLAG
Opened	Low	127 °C	B2 and B4
Shorted	Low	127 °C	B4

SMBus interface

The device can communicate over a standard 2-wire serial interface System Management Bus (SMBus) using the device pins SCLK and SDATA. The device employs four standard SMBus protocols:

Write Byte, Read Byte, Send Byte and Receive Byte. Data formats of those protocols are shown in Table 8 with following notifications:

- The SMBus master initiates data transfer by establishing a start condition (S) and terminates data transfer by generating a stop condition (P).
- Data is sent over the serial bus in sequence of 9 clock pulses according to each 8-bit data byte followed by 1-bit status of the device acknowledgement.
- The 7-bit slave address is equivalent to the selected address of the device.
- The command byte is equivalent to the selected command of the device register
- The send byte format is often used for the one-shot conversion command.
- The receive byte format is used for quicker transfer data from a device reading register which was previously selected by a read byte format.

Table 8. SMBus programming format

Write byte format (for writing data byte to the device register):

S	ADDRESS	WR	ACK	COMMAND	ACK	DATA	ACK	P
	7 bits device address	1 bit = 0	by device	8 bits device register	by device	8 bits to register	by device	

Read byte format (for reading data byte from the device register):

S	ADDRESS	WR	ACK	COMMAND	ACK	S	ADDRESS	RD	ACK	DATA	NACK	P
	7 bits device address	1 bit = 0	by device	8 bits device register	by device		7 bits device address	1 bit = 1	by device	8 bits from register	by controller	

Send byte format (for sending command without data, such as one-shot command):

S	ADDRESS	WR	ACK	COMMAND	ACK	P
	7 bits device address	1 bit = 0	by device	8 bits device register	by device	

Receive byte format (for continuously reading from device register):

S	ADDRESS	RD	ACK	DATA	NACK	P
	7 bits device address	1 bit = 1	by device	8 bits from register	by controller	

NOTES:

S = Start condition

P = Stop condition

ACK = Acknowledged

NACK = Not acknowledged

Temperature monitor for microprocessor systems

NE1617A

PC BOARD LAYOUT CONSIDERATION

Because the NE1617A is used to measure a very small voltage in the range of microvolts from the remote sensor, care must be taken to minimize noise induced at the sensor inputs, especially in the computer motherboard noisy environment. The following precautions should be considered:

- Place the NE1617A as close as possible to the remote sensor. It can be from 4 to 8 inches, as long as the worst noise sources such as clock generator, data and address buses, CRTs are avoided.
- Route the D+ and D- lines in parallel and close together with ground guards enclosed (refer to Figure 12).
- Leakage currents due to PC board contamination could affect the temperature accuracy and must be considered. Error can be introduced by the leakage current as shown on the characteristics curve (Figure 5: Temperature Error vs. PC Board Resistance).
- Use wide tracks to reduce inductance and noise pickup that may be introduced by narrow ones. The width of 10 mil and space of 10 mil are recommended.

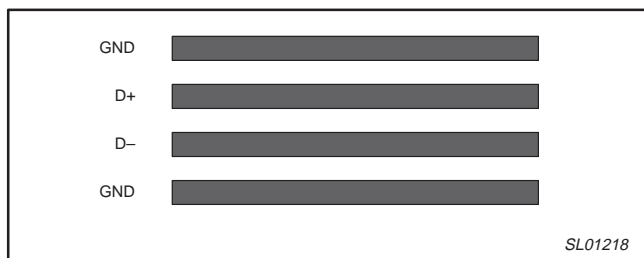

Figure 12. PCB layout for D+ and D-

- Place a bypass capacitor of 0.1 μ F close to the V_{DD} pin and an input filter capacitor of 2200 pF close to the D+ and D- pins.
- If the remote sensor is operating in a noisy environment and located several feet away from the NE1617A, a shielded twisted pair cable is recommended. Make sure the shield of the cable is connected to the NE1617A ground pin, and leave the shield at the remote end unconnected. Shield connecting to ground of both ends could create a ground loop (refer to Figure 13) and defeat the purpose of the shielded cable. Also, cold soldered joints and damaged cable could introduce series resistance and result in measurement error. For instance, a 1 Ω resistance can introduce a change of temperature of about 0.5 $^{\circ}$ C.

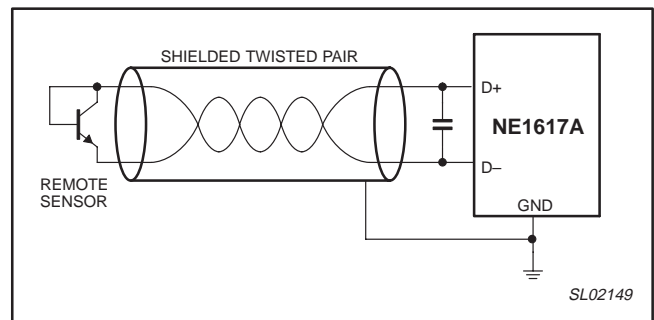

Figure 13. Using shielded twisted pair

Temperature monitor for microprocessor systems

NE1617A

SSOP16: plastic shrink small outline package; 16 leads;
body width 3.9 mm; lead pitch 0.635 mm

SOT519-1

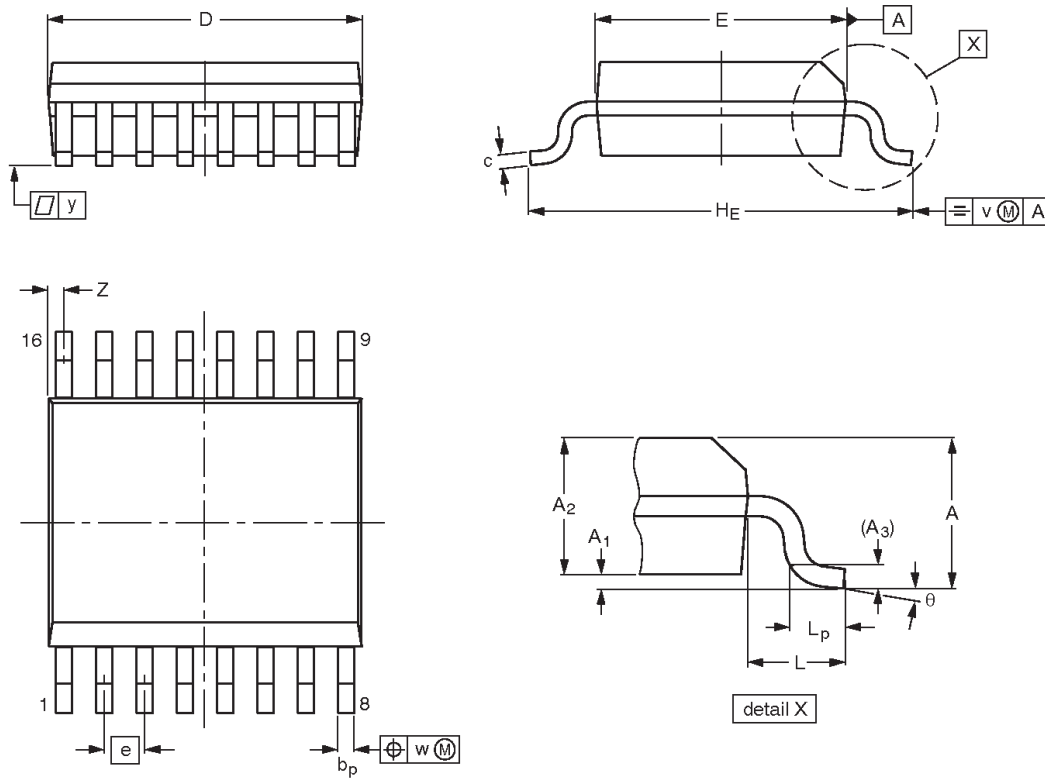

DIMENSIONS (mm are the original dimensions)

UNIT	A max.	A ₁	A ₂	A ₃	b _p	c	D ⁽¹⁾	E ⁽¹⁾	e	H _E	L	L _p	v	w	y	Z ⁽¹⁾	θ
mm	1.73	0.25 0.10	1.55 1.40	0.25	0.31 0.20	0.25 0.18	5.0 4.8	4.0 3.8	0.635	6.2 5.8	1	0.89 0.41	0.2	0.18	0.09	0.18 0.05	8° 0°

Note

1. Plastic or metal protrusions of 0.2 mm maximum per side are not included.

OUTLINE VERSION	REFERENCES				EUROPEAN PROJECTION	ISSUE DATE
	IEC	JEDEC	JEITA			
SOT519-1						-99-05-04 03-02-18

Temperature monitor for microprocessor systems

NE1617A

REVISION HISTORY

Rev	Date	Description
3	20041005	<p>Product data sheet (9397 750 14162). Supersedes data of 2001 Dec 14 (9397 750 09273).</p> <p>Modifications:</p> <ul style="list-style-type: none"> ● “Features” section on page 2: <ul style="list-style-type: none"> – 3rd bullet replace sub-bullets with small table – 6th bullet: add “up to 100 kHz” – 7th bullet: add “5.5 V tolerant” – add 11th and 12th bullets ● “Pin configuration” and “Pin description” sections: modify names of test pins ● “Ordering information” table: add “Topside marking” ● Figure 2, “Functional block diagram” modified. ● Section “Typical operating circuit” changed to “Typical application circuit” <ul style="list-style-type: none"> – Figure 3 modified; note re-written; one note deleted ● “Absolute maximum ratings” table: Operating temperature range max. changed from “+120 °C” to “+125 °C”. ● Section “SMBus interface AC specifications” on page 6: move note below table and number it “1”; add Note 2. Add references to the notes. ● Figure 5: title modified ● Section “Remote diode selection” on page 9: <ul style="list-style-type: none"> – Add definition of ΔV{BE} – Second paragraph: change from “The NE1617A provides two current sources of about 10 μA and 100 μA in measuring the remote diode VBE and the sensed voltage ...” to “The NE1617A forces two well-controlled current sources of about 10 μA and 100 μA in measuring the remote diode VBD. The sensed voltage ...” ● Add section “No calibration is required” on page 9. ● Section “PC board layout consideration” on page 14: <ul style="list-style-type: none"> – Add title to (new) Figure 12. – Add new Figure 13. – Last paragraph re-written.
_2	20011214	<p>Product data (9397 750 09273). ECN 853-2203 27461 of 14 December 2001. Supersedes data of 2000 Jul 13 (9397 750 07322).</p>
_1	20000713	<p>(9397 750 07322)</p>

Temperature monitor for microprocessor systems

NE1617A

Data sheet status

Level	Data sheet status ^[1]	Product status ^{[2] [3]}	Definitions
I	Objective data sheet	Development	This data sheet contains data from the objective specification for product development. Philips Semiconductors reserves the right to change the specification in any manner without notice.
II	Preliminary data sheet	Qualification	This data sheet contains data from the preliminary specification. Supplementary data will be published at a later date. Philips Semiconductors reserves the right to change the specification without notice, in order to improve the design and supply the best possible product.
III	Product data sheet	Production	This data sheet contains data from the product specification. Philips Semiconductors reserves the right to make changes at any time in order to improve the design, manufacturing and supply. Relevant changes will be communicated via a Customer Product/Process Change Notification (CPCN).

[1] Please consult the most recently issued data sheet before initiating or completing a design.

[2] The product status of the device(s) described in this data sheet may have changed since this data sheet was published. The latest information is available on the Internet at URL <http://www.semiconductors.philips.com>.

[3] For data sheets describing multiple type numbers, the highest-level product status determines the data sheet status.

Definitions

Short-form specification — The data in a short-form specification is extracted from a full data sheet with the same type number and title. For detailed information see the relevant data sheet or data handbook.

Limiting values definition — Limiting values given are in accordance with the Absolute Maximum Rating System (IEC 60134). Stress above one or more of the limiting values may cause permanent damage to the device. These are stress ratings only and operation of the device at these or at any other conditions above those given in the Characteristics sections of the specification is not implied. Exposure to limiting values for extended periods may affect device reliability.

Application information — Applications that are described herein for any of these products are for illustrative purposes only. Philips Semiconductors make no representation or warranty that such applications will be suitable for the specified use without further testing or modification.

Disclaimers

Life support — These products are not designed for use in life support appliances, devices, or systems where malfunction of these products can reasonably be expected to result in personal injury. Philips Semiconductors customers using or selling these products for use in such applications do so at their own risk and agree to fully indemnify Philips Semiconductors for any damages resulting from such application.

Right to make changes — Philips Semiconductors reserves the right to make changes in the products—including circuits, standard cells, and/or software—described or contained herein in order to improve design and/or performance. When the product is in full production (status 'Production'), relevant changes will be communicated via a Customer Product/Process Change Notification (CPCN). Philips Semiconductors assumes no responsibility or liability for the use of any of these products, conveys no license or title under any patent, copyright, or mask work right to these products, and makes no representations or warranties that these products are free from patent, copyright, or mask work right infringement, unless otherwise specified.

Contact information

For additional information please visit
<http://www.semiconductors.philips.com>. Fax: +31 40 27 24825

© Koninklijke Philips Electronics N.V. 2004
 All rights reserved. Published in the U.S.A.

Date of release: 10-04

For sales offices addresses send e-mail to:
sales.addresses@www.semiconductors.philips.com

Document number:

9397 750 14162

Let's make things better.