

T-1 PACKAGE SOLID STATE LAMP

MVL-354B

Description

The MVL-354B, a blue source color device, is made with InGaN (on SiC substrate) LED die.
The package is T-1(ϕ 3mm) water clear plastic type.

Package Dimensions

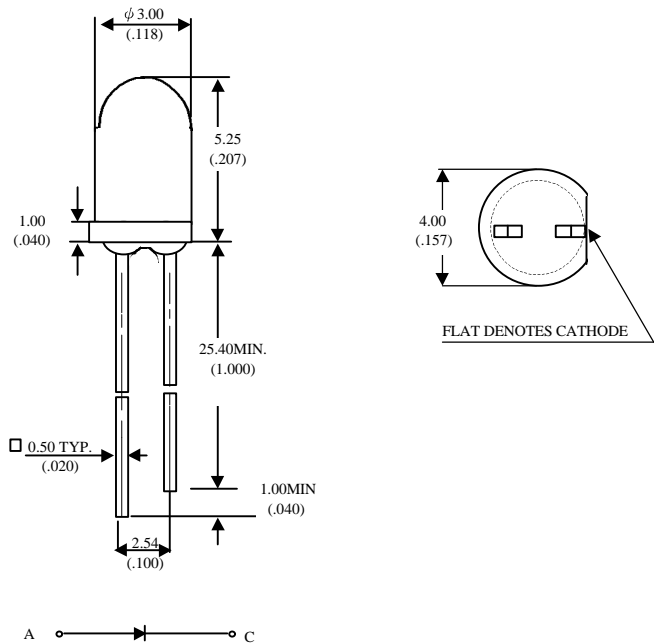

Applications

- Full color displays & moving message signs
- Solid state incandescent replacement bulbs
- High ambient panel indicators
- Color printers & scanners
- Medical & Analytical instruments

Features

- High performance - 2.5mW (470nm)
- Superior SiC substrate technology
- Excellent chip to chip consistency
- High reliability

Notes :

1. Tolerance is ± 0.25 mm (.010") unless otherwise noted.
2. Protruded resin under flange is 0.8 mm (.031") max.
3. Lead spacing is measured where the leads emerge from the package.

Absolute Maximum Ratings

@ $T_A=25^\circ\text{C}$

Parameter	Symbol	Maximum Rating	Unit
Peak Forward Current(1/10 Duty Cycle@1KHz)	I_{pf}	100	mA
Continuous Forward Current	I_{af}	30	mA
Reverse Voltage	V_R	5	V
Operating Temperature Range	T_{opr}	-20 $^\circ\text{C}$ to +80 $^\circ\text{C}$	
Storage Temperature Range	T_{stg}	-30 $^\circ\text{C}$ to +100 $^\circ\text{C}$	
Electrostatic Discharge Threshold(HBM)	E_{ot}	1000	V
Solder temperature 1.6 mm from body for 3 seconds at 260 $^\circ\text{C}$			

UNI

Unity Opto Technology Co., Ltd.

08/25/2000

Optical-Electrical Characteristics

@ T_A=25 °C

Parameter	Test Conditions	Symbol	Min .	Typ .	Max .	Unit .
Luminous Intensity	I _F =20mA	I _V	180	350	-	mcd
Forward Voltage	I _F =20mA	V _F	-	3.5	4.0	V
Reverse Current	V _R =5V	I _R	-	-	10	μA
Dominant Wavelength	I _F =20mA	λ _d	-	470	-	nm
Viewing Angle	I _F =20mA	2θ _{1/2}	-	30	-	deg.

Typical Optical-Electrical Characteristic Curves

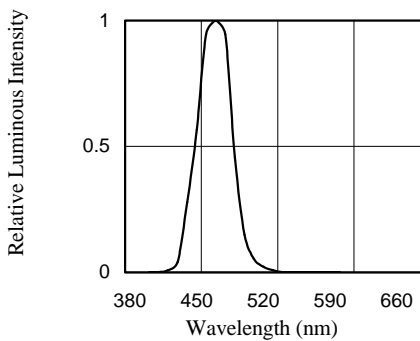

FIG.1 RELATIVE INTENSITY LUMINOUS VS. WAVELENGTH

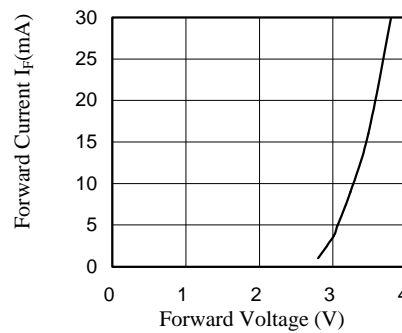

FIG.2 FORWARD CURRENT VS. FORWARD VOLTAGE

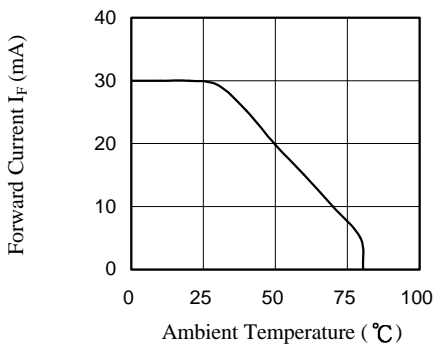

FIG.3 FORWARD CURRENT VS. AMBIENT TEMPERATURE

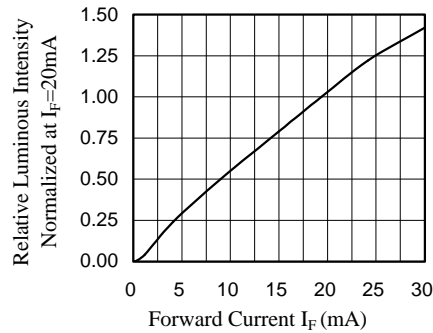

FIG.4 RELATIVE LUMINOUS INTENSITY VS. FORWARD CURRENT

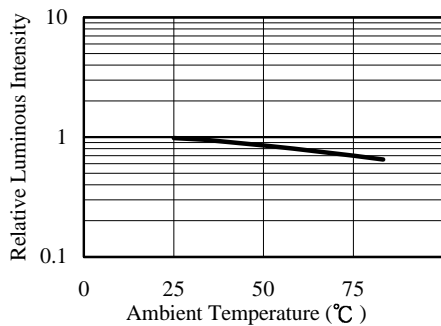

FIG.5 LUMINOUS INTENSITY VS. AMBIENT TEMPERATURE

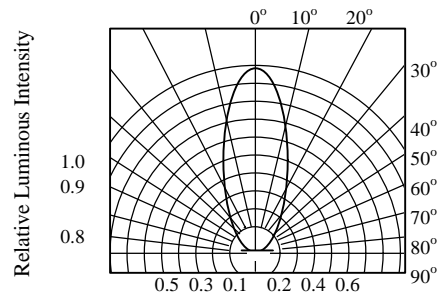

FIG.6 RADIATION DIAGRAM