

The RF Small Signal Line
**NPN Silicon Low Voltage,
Low Current, Low Noise,
High-Frequency Transistors**

Designed for use in low voltage, low current applications at frequencies to 2.0 GHz. Specifically aimed at portable communication devices such as pagers and hand-held phones.

- High Gain (G_{Umax} 15 dB Typ @ 1.0 GHz) @ 1.0 mA
- Small, Surface-Mount Package (SC-70)
- High Current Gain-Bandwidth Product at Low Current, Low Voltage ($f_T = 8.0$ GHz Typ @ 3.0 V, 5.0 mA)
- Available in Tape and Reel by Adding T1 or T3 Suffix to Part Number.
T1 Suffix = 3,000 Units per 8 mm, 7 inch Reel.
T3 Suffix = 10,000 Units per 8 mm, 7 inch Reel.

MRF927T1
MRF927T3

$I_C = 10$ mA
LOW NOISE
HIGH FREQUENCY
TRANSISTOR

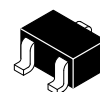

CASE 419-02, STYLE 3
(SC-70/SOT-323)

MAXIMUM RATINGS

Rating	Symbol	Value	Unit
Collector-Emitter Voltage	V_{CEO}	10	Vdc
Collector-Base Voltage	V_{CBO}	20	Vdc
Emitter-Base Voltage	V_{EBO}	2.5	Vdc
Collector Current — Continuous	I_C	10	mAdc
Total Device Dissipation @ $T_C = 50^\circ\text{C}$ Derate above 50°C	P_D	100 1.0	mW mW/ $^\circ\text{C}$
Storage Temperature Range	T_{stg}	- 55 to +150	$^\circ\text{C}$
Operating Temperature Range	T_J	150	$^\circ\text{C}$

THERMAL CHARACTERISTICS

Characteristic	Symbol	Value	Unit
Thermal Resistance, Junction-to-Case	$R_{\theta JC}$	1000	$^\circ\text{C}/\text{W}$

DEVICE MARKING

MRF927T1 = F

ELECTRICAL CHARACTERISTICS ($T_C = 25^\circ\text{C}$ unless otherwise noted)

Characteristic	Symbol	Min	Typ	Max	Unit
OFF CHARACTERISTICS					
Collector–Emitter Breakdown Voltage ($I_C = 0.1\text{ mA}$, $I_B = 0\text{ mA}$)	$V_{(BR)CEO}$	10	—	—	Vdc
Collector–Base Breakdown Voltage ($I_C = 0.1\text{ mA}$, $I_E = 0$)	$V_{(BR)CBO}$	20	—	—	Vdc
Emitter–Base Breakdown Voltage ($I_E = 0.1\text{ mA}$, $I_C = 0$)	$V_{(BR)EBO}$	1.5	—	—	Vdc
Emitter Cutoff Current ($V_{EB} = 1.0\text{ Vdc}$, $I_C = 0$)	I_{EBO}	—	—	0.1	μA
ON CHARACTERISTICS					
DC Current Gain ($V_{CE} = 1.0\text{ Vdc}$, $I_C = 0.5\text{ mA}$)	h_{FE}	50	—	200	—
DYNAMIC CHARACTERISTICS					
Collector–Base Capacitance ($V_{CB} = 1.0\text{ Vdc}$, $I_E = 0$, $f = 1.0\text{ MHz}$)	C_{cb}	—	0.33	—	pF
Current–Gain Bandwidth Product ($V_{CE} = 3.0\text{ Vdc}$, $I_E = 5.0\text{ mA}$, $f = 1.0\text{ GHz}$)	f_τ	—	8.0	—	GHz
PERFORMANCE CHARACTERISTICS					
Noise Figure — Minimum ($V_{CE} = 1.0\text{ Vdc}$, $I_C = 1.0\text{ mA}$, $f = 1000\text{ MHz}$) Figure 3	N_{Fmin}	—	1.7	—	dB
Associated Gain at Minimum Noise Figure ($V_{CE} = 1.0\text{ Vdc}$, $I_C = 1.0\text{ mA}$, $f = 1000\text{ MHz}$) Figure 3	G_{NF}	—	9.8	—	dB
Maximum Unilateral Gain ($V_{CE} = 1.0\text{ Vdc}$, $I_C = 1.0\text{ mA}$, $f = 1000\text{ MHz}$)	G_{Umax}	—	15	—	dB
Insertion Gain ($V_{CE} = 1.0\text{ Vdc}$, $I_C = 1.0\text{ mA}$, $f = 1000\text{ MHz}$)	$ S_{21} ^2$	—	8.0	—	dB
Noise Resistance ($V_{CE} = 1.0\text{ Vdc}$, $I_C = 1.0\text{ mA}$, $f = 1000\text{ MHz}$)	R_N	—	62	—	Ohms

TYPICAL CHARACTERISTICS

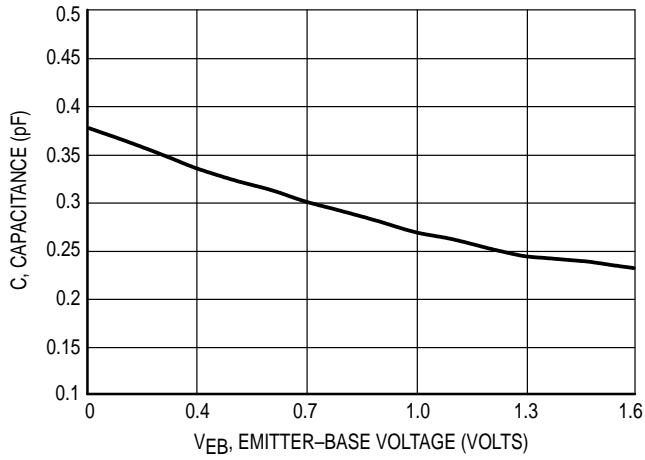

Figure 1. C_{1b} Input Capacitance versus Voltage

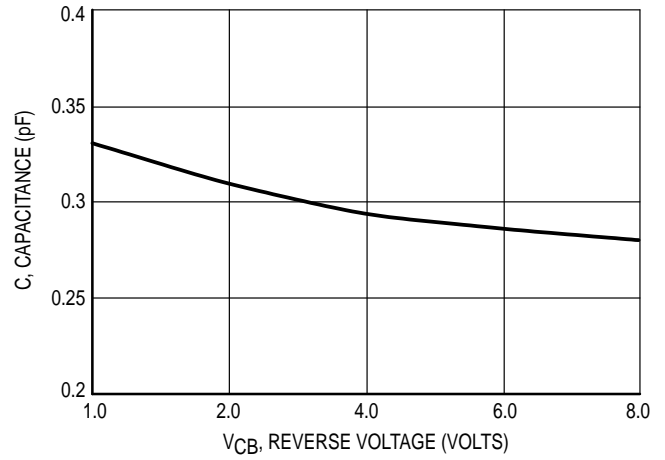

Figure 2. C_{1c} Collector-Base Capacitance versus Voltage

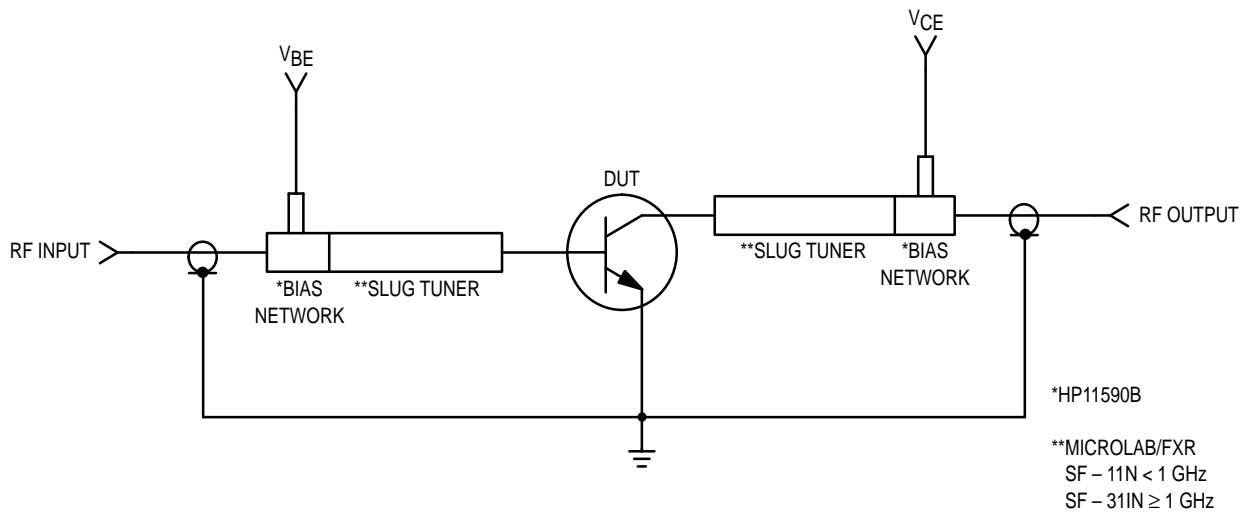

Figure 3. Functional Circuit Schematic

TYPICAL CHARACTERISTICS

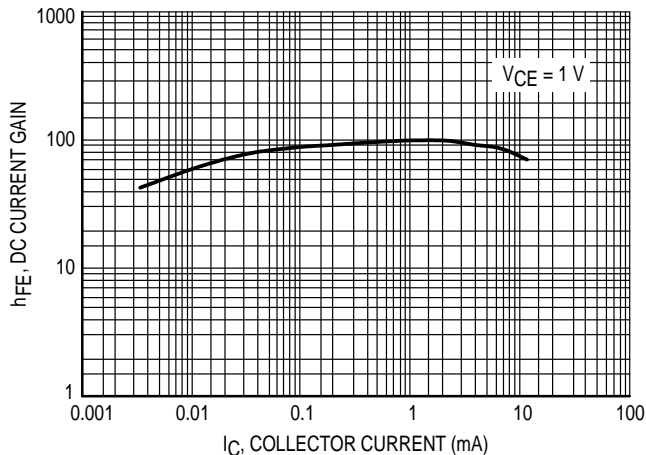

Figure 4. DC Current Gain versus Collector Current

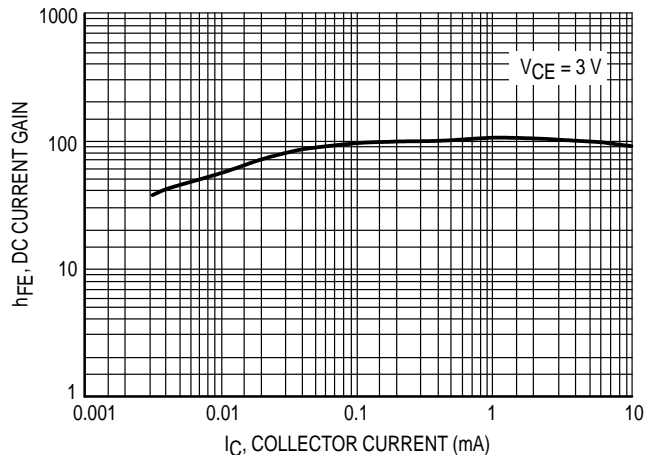

Figure 5. DC Current Gain versus Collector Current

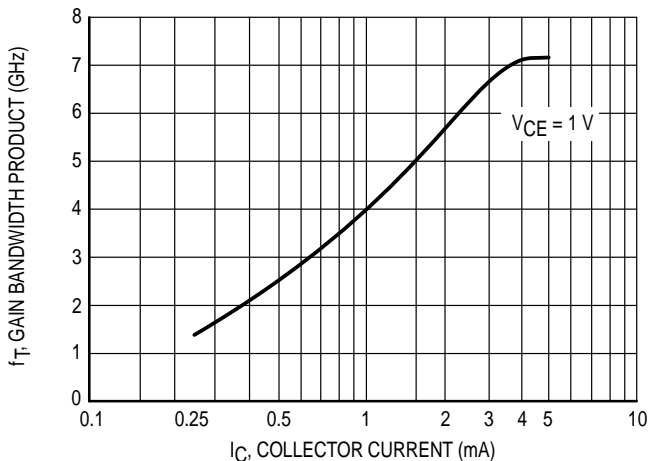

Figure 6. Gain Bandwidth Product versus Collector Current

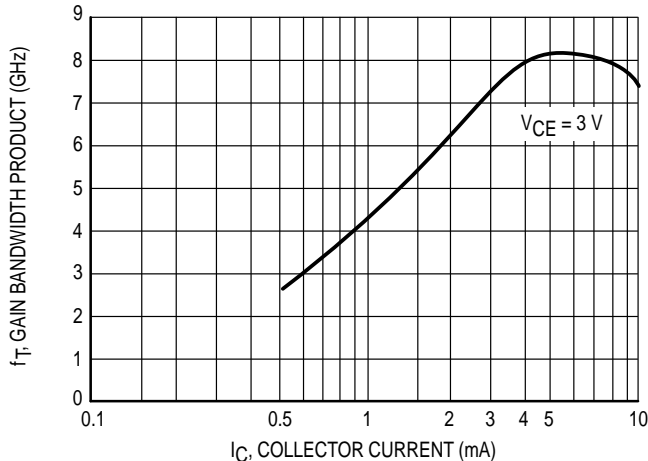

Figure 7. Gain Bandwidth Product versus Collector Current

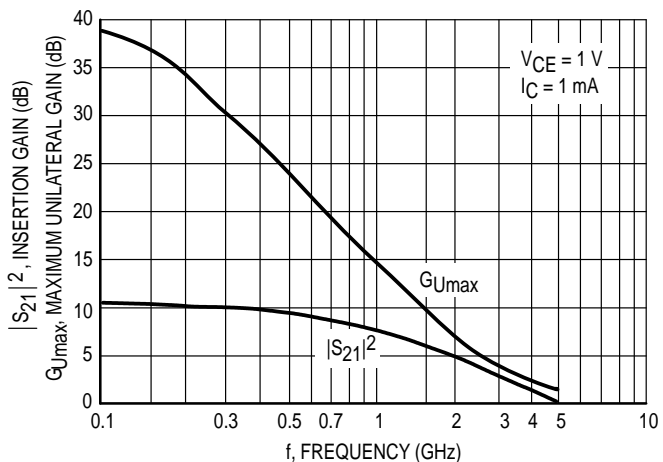

Figure 8. Forward Insertion Gain and Maximum Unilateral Gain versus Frequency

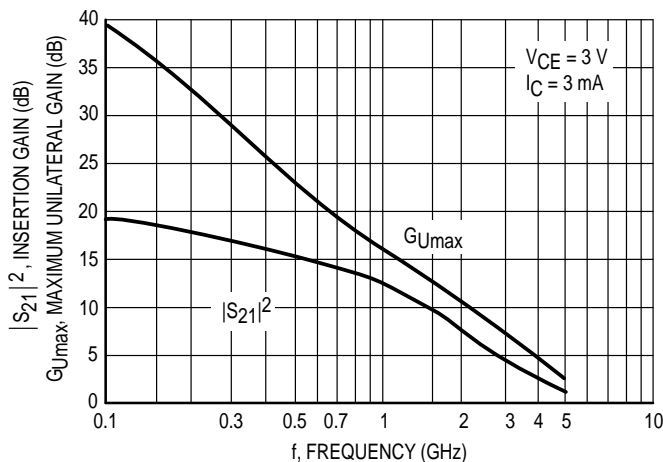

Figure 9. Forward Insertion Gain and Maximum Unilateral Gain versus Frequency

TYPICAL CHARACTERISTICS

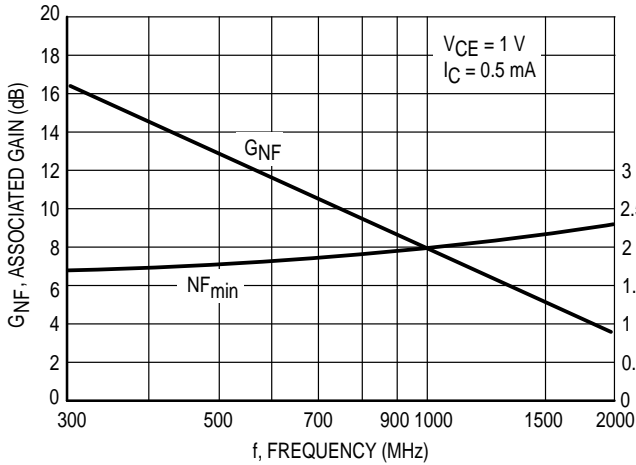

Figure 10. Minimum Noise Figure and Associated Gain versus Frequency

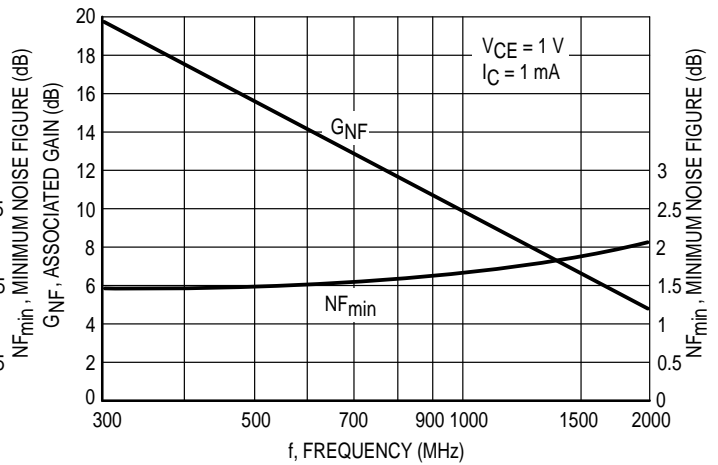

Figure 11. Minimum Noise Figure and Associated Gain versus Frequency

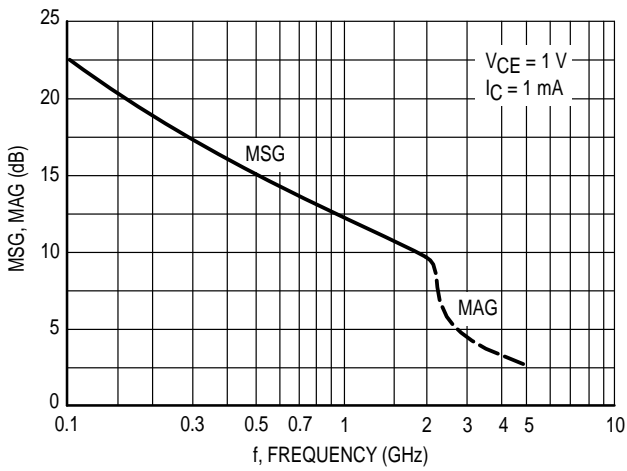

Figure 12. MSG, Maximum Stable Gain; MAG, Maximum Available Gain versus Frequency

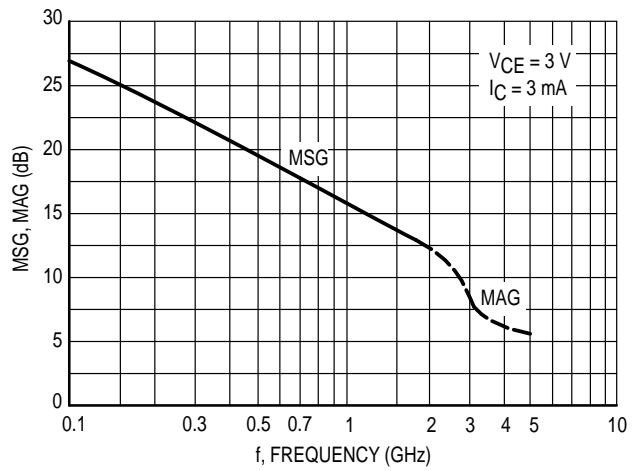

Figure 13. MSG, Maximum Stable Gain; MAG, Maximum Available Gain versus Frequency

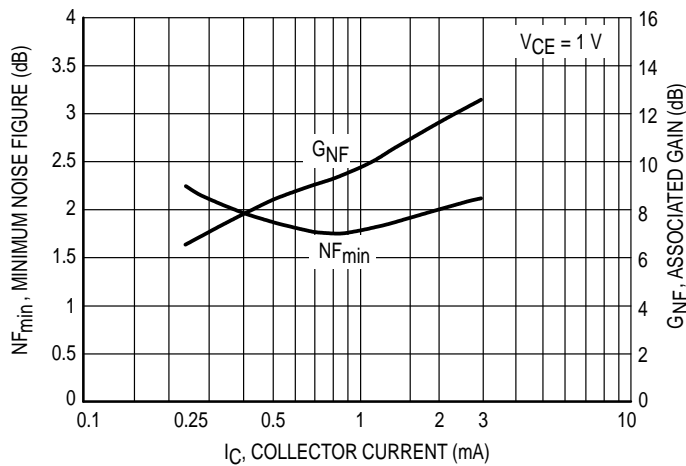

Figure 14. Noise Figure and Gain @ Minimum Noise Figure versus Collector Current

V _{CE} (Vdc)	I _C (mA)	f (GHz)	S ₁₁		S ₂₁		S ₁₂		S ₂₂		
			S ₁₁	∠ φ	S ₂₁	∠ φ	S ₁₂	∠ φ	S ₂₂	∠ φ	
1.0	0.25	0.10	0.992	-4	0.911	174	0.020	86	0.997	-3	
		0.20	0.990	-9	0.903	169	0.039	83	0.993	-6	
		0.30	0.983	-13	0.909	163	0.059	80	0.992	-8	
		0.40	0.978	-17	0.904	157	0.077	77	0.988	-11	
		0.50	0.973	-21	0.834	149	0.095	72	0.975	-13	
		0.60	0.943	-25	0.892	144	0.111	69	0.966	-16	
		0.70	0.929	-29	0.873	139	0.127	66	0.958	-19	
		0.80	0.889	-33	0.901	135	0.142	63	0.949	-22	
		0.90	0.895	-37	0.888	129	0.158	60	0.939	-24	
		1.00	0.876	-41	0.890	124	0.171	57	0.929	-26	
		1.50	0.772	-60	0.871	100	0.227	44	0.873	-38	
		2.00	0.670	-78	0.835	80	0.261	34	0.823	-48	
		2.50	0.564	-96	0.812	62	0.276	25	0.776	-58	
		3.00	0.477	-114	0.785	48	0.276	18	0.741	-68	
		3.50	0.412	-132	0.741	36	0.270	15	0.722	-77	
	4.00	0.364	-151	0.701	25	0.261	14	0.711	-87		
	4.50	0.308	-172	0.702	17	0.261	18	0.682	-97		
	5.00	0.297	166	0.639	11	0.270	22	0.686	-107		
	0.5	0.5	0.10	0.983	-5	1.788	174	0.020	86	0.994	-3
			0.20	0.977	-10	1.763	168	0.040	82	0.992	-7
			0.30	0.965	-16	1.764	162	0.059	79	0.984	-10
			0.40	0.953	-21	1.735	156	0.077	76	0.976	-13
			0.50	0.947	-26	1.637	147	0.094	70	0.954	-16
			0.60	0.901	-30	1.673	142	0.109	67	0.941	-19
			0.70	0.878	-34	1.619	137	0.124	64	0.927	-21
			0.80	0.827	-38	1.601	132	0.136	62	0.912	-24
			0.90	0.825	-43	1.594	127	0.151	58	0.893	-27
			1.00	0.796	-48	1.571	122	0.162	56	0.877	-29
			1.50	0.659	-67	1.420	99	0.207	45	0.797	-40
			2.00	0.535	-85	1.275	80	0.232	37	0.733	-49
2.50			0.417	-102	1.177	63	0.247	32	0.678	-58	
3.00			0.332	-122	1.097	50	0.256	29	0.639	-67	
3.50			0.271	-143	1.014	38	0.265	28	0.617	-75	
4.00	0.238	-164	0.949	28	0.279	29	0.604	-84			
4.50	0.212	170	0.928	19	0.305	31	0.573	-94			
5.00	0.218	147	0.856	12	0.333	31	0.574	-105			
1.0	1.0	0.10	0.965	-7	3.383	172	0.020	85	0.990	-4	
		0.20	0.952	-14	3.315	165	0.040	81	0.982	-9	
		0.30	0.928	-20	3.277	157	0.057	77	0.965	-13	
		0.40	0.905	-26	3.172	151	0.074	73	0.947	-16	
		0.50	0.88	-33	3.027	141	0.090	67	0.910	-19	
		0.60	0.819	-37	2.936	136	0.102	64	0.887	-23	
		0.70	0.783	-42	2.804	130	0.115	61	0.861	-26	
		0.80	0.725	-47	2.666	125	0.125	59	0.839	-28	
		0.90	0.702	-52	2.623	119	0.136	56	0.810	-31	
		1.00	0.664	-57	2.525	114	0.145	54	0.787	-33	
		1.50	0.504	-75	2.085	93	0.181	47	0.690	-42	
		2.00	0.382	-92	1.759	75	0.207	42	0.626	-50	
		2.50	0.278	-108	1.548	61	0.229	40	0.577	-58	
		3.00	0.21	-129	1.397	48	0.252	38	0.543	-66	
		3.50	0.168	-154	1.271	38	0.276	36	0.523	-73	
4.00	0.15	-177	1.177	28	0.303	35	0.513	-82			
4.50	0.148	155	1.123	19	0.336	34	0.490	-91			
5.00	0.165	132	1.049	12	0.369	32	0.487	-101			

Table 1. Common Emitter S-Parameters

V _{CE} (Vdc)	I _C (mA)	f (GHz)	S ₁₁		S ₂₁		S ₁₂		S ₂₂	
			S ₁₁	∠ φ	S ₂₁	∠ φ	S ₁₂	∠ φ	S ₂₂	∠ φ
1.0	2.0	0.10	0.928	-10	6.181	169	0.020	83	0.980	-6
		0.20	0.901	-19	5.967	160	0.037	78	0.959	-12
		0.30	0.856	-28	5.744	150	0.054	73	0.923	-17
		0.40	0.811	-36	5.410	142	0.068	69	0.886	-22
		0.50	0.753	-43	5.051	132	0.080	63	0.828	-25
		0.60	0.681	-48	4.679	126	0.091	61	0.790	-28
		0.70	0.632	-54	4.367	119	0.100	59	0.753	-31
		0.80	0.574	-59	4.021	114	0.108	57	0.726	-33
		0.90	0.538	-64	3.831	109	0.116	55	0.692	-35
		1.00	0.497	-68	3.595	104	0.123	54	0.667	-37
		1.50	0.349	-86	2.732	85	0.156	50	0.576	-44
		2.00	0.255	-102	2.200	70	0.186	47	0.527	-50
		2.50	0.182	-120	1.871	57	0.216	45	0.491	-58
		3.00	0.137	-143	1.647	46	0.246	42	0.469	-66
		3.50	0.115	-167	1.478	36	0.276	39	0.460	-73
		4.00	0.109	167	1.356	27	0.306	36	0.453	-81
4.50	0.115	138	1.268	19	0.337	33	0.443	-89		
5.00	0.136	119	1.190	11	0.368	30	0.441	-98		

Table 1. Common Emitter S-Parameters (continued)

V _{CE} (Vdc)	I _C (mA)	f (GHz)	S ₁₁		S ₂₁		S ₁₂		S ₂₂	
			S ₁₁	∠ φ	S ₂₁	∠ φ	S ₁₂	∠ φ	S ₂₂	∠ φ
3.0	0.5	0.10	0.985	-5	1.796	174	0.018	86	0.995	-3
		0.20	0.980	-10	1.776	169	0.034	83	0.993	-6
		0.30	0.969	-15	1.778	163	0.051	79	0.986	-9
		0.40	0.959	-19	1.753	157	0.066	76	0.980	-12
		0.50	0.952	-24	1.651	149	0.081	71	0.961	-14
		0.60	0.910	-28	1.693	144	0.095	68	0.949	-17
		0.70	0.888	-32	1.639	139	0.108	65	0.937	-20
		0.80	0.841	-36	1.628	134	0.119	63	0.924	-23
		0.90	0.839	-41	1.618	129	0.131	60	0.908	-25
		1.00	0.812	-45	1.596	124	0.142	57	0.894	-27
		1.50	0.681	-64	1.445	102	0.184	47	0.824	-38
		2.00	0.565	-80	1.294	83	0.210	39	0.768	-47
		2.50	0.455	-96	1.190	66	0.226	33	0.720	-56
		3.00	0.369	-112	1.106	53	0.237	30	0.687	-64
		3.50	0.308	-128	1.019	41	0.246	28	0.670	-72
		4.00	0.264	-146	0.950	30	0.256	28	0.661	-81
4.50	0.212	-166	0.933	21	0.274	29	0.638	-89		
5.00	0.201	171	0.858	13	0.294	30	0.642	-99		
3.0	1.0	0.10	0.969	-6	3.341	173	0.017	85	0.992	-4
		0.20	0.958	-13	3.284	166	0.034	81	0.985	-8
		0.30	0.938	-19	3.255	159	0.050	78	0.972	-11
		0.40	0.917	-24	3.163	152	0.064	74	0.957	-15
		0.50	0.896	-30	3.019	143	0.078	68	0.925	-18
		0.60	0.838	-35	2.951	138	0.089	66	0.905	-21
		0.70	0.805	-40	2.823	132	0.101	63	0.883	-23
		0.80	0.750	-44	2.700	127	0.110	61	0.864	-26
		0.90	0.732	-49	2.661	122	0.121	58	0.838	-28
		1.00	0.696	-53	2.570	117	0.129	56	0.818	-31
		1.50	0.541	-71	2.139	95	0.163	48	0.731	-40
		2.00	0.424	-86	1.807	78	0.188	43	0.674	-47
		2.50	0.325	-100	1.588	63	0.210	40	0.629	-55
		3.00	0.252	-116	1.430	51	0.230	37	0.600	-63
		3.50	0.204	-132	1.294	40	0.250	36	0.589	-70
		4.00	0.170	-150	1.195	30	0.272	34	0.581	-78
4.50	0.136	-173	1.141	21	0.297	33	0.565	-86		
5.00	0.134	162	1.063	13	0.323	32	0.566	-95		

Table 2. Common Emitter S-Parameters

V _{CE} (Vdc)	I _C (mA)	f (GHz)	S ₁₁		S ₂₁		S ₁₂		S ₂₂		
			S ₁₁	∠ φ	S ₂₁	∠ φ	S ₁₂	∠ φ	S ₂₂	∠ φ	
3.0	3.0	0.10	0.902	-11	8.541	168	0.017	83	0.976	-7	
		0.20	0.863	-21	8.133	156	0.031	77	0.946	-13	
		0.30	0.805	-31	7.647	146	0.045	73	0.901	-18	
		0.40	0.746	-39	7.050	137	0.056	69	0.856	-22	
		0.50	0.673	-45	6.436	127	0.066	65	0.794	-24	
		0.60	0.604	-50	5.853	121	0.074	63	0.757	-27	
		0.70	0.552	-55	5.378	115	0.082	61	0.721	-29	
		0.80	0.499	-59	4.897	110	0.089	60	0.697	-30	
		0.90	0.461	-63	4.586	105	0.096	59	0.667	-32	
		1.00	0.424	-66	4.260	100	0.103	59	0.647	-33	
		1.50	0.295	-80	3.141	83	0.136	56	0.578	-38	
		2.00	0.215	-91	2.494	70	0.169	54	0.542	-44	
		2.50	0.152	-105	2.101	58	0.201	51	0.514	-51	
		3.00	0.108	-124	1.837	47	0.232	47	0.497	-59	
		3.50	0.083	-146	1.641	38	0.263	44	0.490	-66	
	4.00	0.071	-173	1.501	30	0.294	41	0.485	-73		
	4.50	0.069	148	1.395	21	0.325	38	0.480	-81		
	5.00	0.090	121	1.310	14	0.357	35	0.478	-90		
	5.0	5.0	0.10	0.839	-15	12.345	164	0.016	81	0.961	-9
			0.20	0.774	-28	11.339	149	0.030	75	0.906	-16
0.30			0.690	-38	10.154	137	0.041	71	0.840	-21	
0.40			0.614	-47	8.971	127	0.050	68	0.780	-24	
0.50			0.528	-52	7.877	119	0.058	65	0.715	-26	
0.60			0.464	-57	6.974	112	0.066	64	0.677	-27	
0.70			0.414	-61	6.267	107	0.073	63	0.646	-28	
0.80			0.370	-65	5.628	102	0.080	63	0.625	-29	
0.90			0.338	-68	5.165	98	0.087	63	0.602	-30	
1.00			0.307	-71	4.742	94	0.094	62	0.587	-31	
1.50			0.207	-83	3.389	79	0.130	61	0.536	-36	
2.00			0.148	-96	2.658	66	0.165	58	0.512	-41	
2.50			0.100	-113	2.221	56	0.200	54	0.490	-49	
3.00			0.072	-138	1.930	46	0.233	51	0.475	-56	
3.50			0.059	-168	1.720	37	0.266	47	0.470	-64	
4.00	0.062	152	1.569	29	0.299	43	0.466	-72			
4.50	0.080	118	1.451	21	0.331	40	0.462	-80			
5.00	0.107	103	1.362	14	0.365	36	0.460	-88			

Table 2. Common Emitter S-Parameters (continued)

V _{CE} (Vdc)	I _C (mA)	f (MHz)	NF _{min} (dB)	Γ _o (MAG, ANG)	R _N (ohms)	
1.0	0.5	300	1.65	0.81 ∠ 8	89	
		500	1.70	0.80 ∠ 13	86	
		900	1.85	0.77 ∠ 23	78	
		1000	1.90	0.77 ∠ 25	76	
		1500	2.05	0.74 ∠ 40	64	
		2000	2.20	0.70 ∠ 56	50	
		1.0	1.0	300	1.45	0.76 ∠ 7
	500			1.47	0.76 ∠ 12	69
	900			1.65	0.75 ∠ 21	63
	1000			1.70	0.74 ∠ 24	62
	1500			1.90	0.71 ∠ 38	53
	2000			2.05	0.67 ∠ 55	44

Table 3. Common-Emitter Noise Parameters

V _{CE} (Vdc)	I _C (mA)	f (MHz)	NF _{min} (dB)	Γ _o (MAG, ANG)	R _N (ohms)
3.0	1.0	300	1.60	0.72 ∠7	61
		500	1.62	0.72 ∠12	60
		900	1.64	0.70 ∠21	57
		1000	1.64	0.70 ∠24	56
		1500	1.70	0.67 ∠39	49
		2000	1.80	0.63 ∠55	41
	3.0	300	1.80	0.63 ∠7	48
		500	1.82	0.62 ∠11	47
		900	1.84	0.60 ∠19	45
		1000	1.85	0.59 ∠22	44
		1500	1.94	0.56 ∠37	40
	2000	2.12	0.51 ∠56	34	

Table 3. Common-Emitter Noise Parameters (continued)

Name	Value	Name	Value	Name	Value
IS	187.1E-18	IRB	80.0E-6	TF	13.0E-12
BF	133	RBM	31	XTF	500
NF	0.9958	RE	3.3	VTF	1.1
VAF	40	RC	6	ITF	0.35
IKF	0.07	XTB	0(1)	PTF	50
ISE	5.393E-12	EG	1.11(1)	TR	2.38E-9
NE	4.933	XTI	3(1)	FC	0.9
BR	17	CJE	280.0E-15	CJS	0(1)
NR	0.9929	VJE	0.884	VJS	1(1)
VAR	2.6	MJE	0.318	MJS	0(1)
IKR	0.018	CJC	290.0E-15	AF	1(1)
ISC	28.92E-18	VJC	0.424	KF	0(1)
NC	1.049	MJC	0.108		
RB	31	XCJC	0.2		

Note

1. These parameters have not been extracted. Default values are shown.

Table 4. Spice Parameters (MRF927 Die Gummel-Poon Parameters)

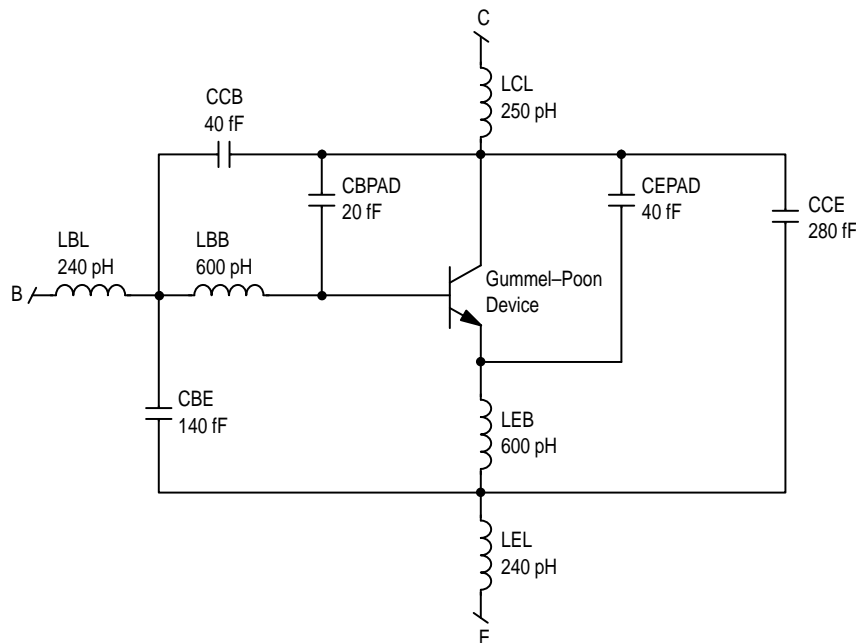
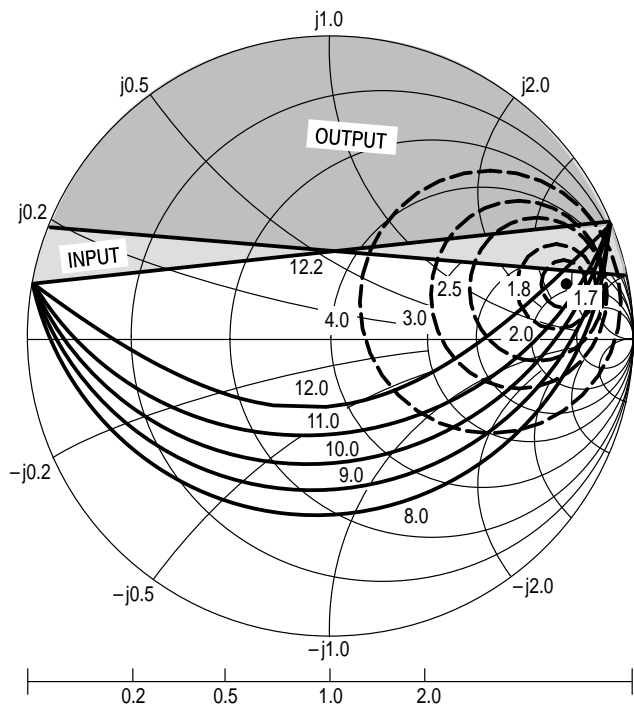

Figure 15. MRF927 SC-70 Package Equivalent Circuit



$V_{CE} = 1.0 \text{ V}$
 $I_C = 0.5 \text{ mA}$
 □ — Potentially Unstable

f (MHz)	NF OPT (dB)	Γ_{MS} NF OPT	Rn	K
500	1.7	$0.80 \angle 13^\circ$	86	0.25

Figure 16. Constant Gain and Noise Figure Contours

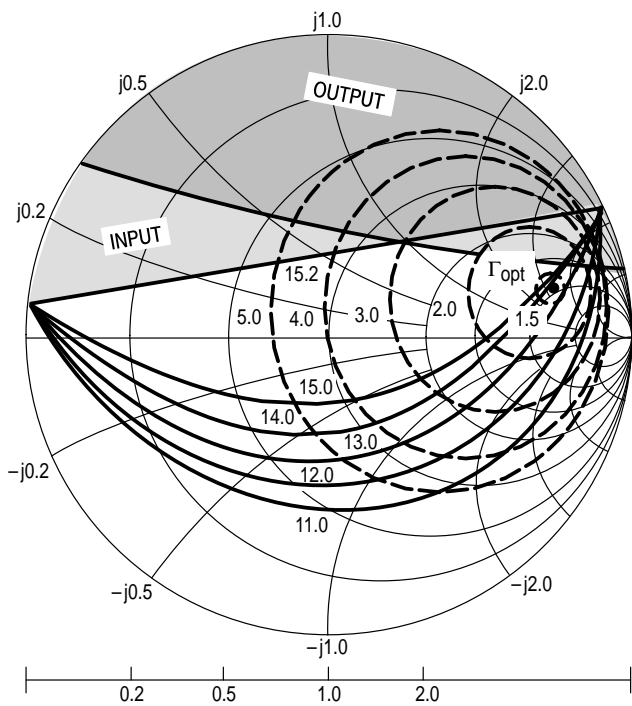

$V_{CE} = 1.0 \text{ V}$
 $I_C = 1.0 \text{ mA}$
 □ — Potentially Unstable

f (MHz)	NF OPT (dB)	Γ_{MS} NF OPT	Rn	K
500	1.47	$0.76 \angle 12^\circ$	69	0.29

Figure 17. Constant Gain and Noise Figure Contours

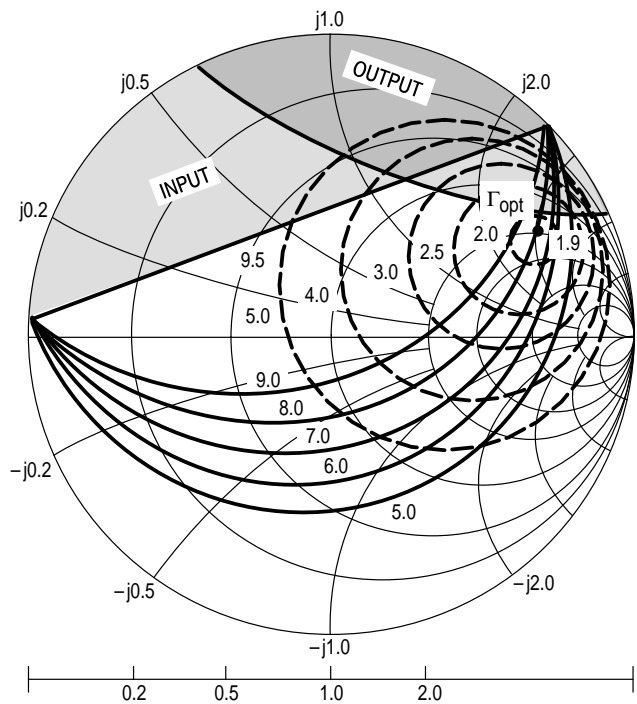

$V_{CE} = 1.0 \text{ V}$
 $I_C = 0.5 \text{ mA}$
 □ — Potentially Unstable

f (MHz)	NF OPT (dB)	Γ_{MS} NF OPT	Rn	K
1000	1.9	$0.77 \angle 25^\circ$	76	0.43

Figure 18. Constant Gain and Noise Figure Contours

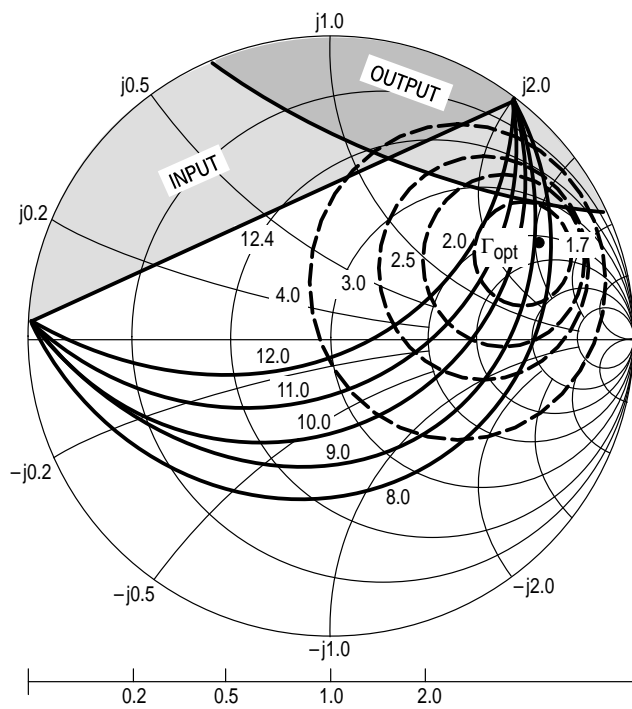

$V_{CE} = 1.0 \text{ V}$
 $I_C = 1.0 \text{ mA}$
 □ — Potentially Unstable

f (MHz)	NF OPT (dB)	Γ_{MS} NF OPT	Rn	K
1000	1.7	$0.74 \angle 24^\circ$	62	0.51

Figure 19. Constant Gain and Noise Figure Contours

PACKAGE DIMENSIONS

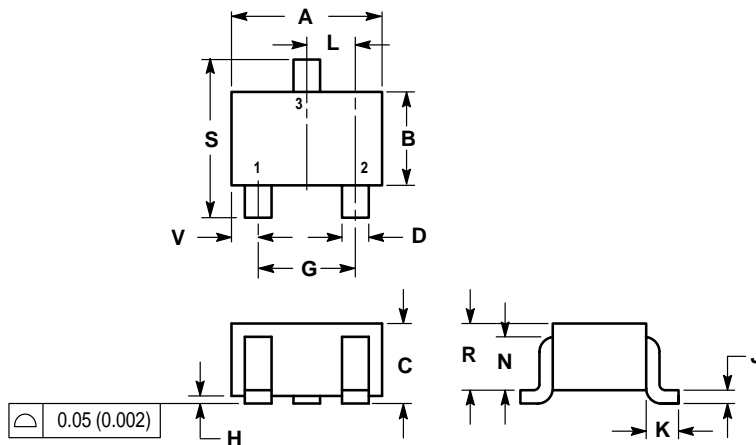

- NOTES:
 1. DIMENSIONING AND TOLERANCING PER ANSI Y14.5M, 1982.
 2. CONTROLLING DIMENSION: INCH.

DIM	INCHES		MILLIMETERS	
	MIN	MAX	MIN	MAX
A	0.071	0.087	1.80	2.20
B	0.045	0.053	1.15	1.35
C	0.035	0.049	0.90	1.25
D	0.012	0.016	0.30	0.40
G	0.047	0.055	1.20	1.40
H	0.000	0.004	0.00	0.10
J	0.004	0.010	0.10	0.25
K	0.017 REF		0.425 REF	
L	0.026 BSC		0.650 BSC	
N	0.028 REF		0.700 REF	
R	0.031	0.039	0.80	1.00
S	0.079	0.087	2.00	2.20
V	0.012	0.016	0.30	0.40

- STYLE 3:
 PIN 1. BASE
 2. EMITTER
 3. COLLECTOR

CASE 419-02 ISSUE H

Motorola reserves the right to make changes without further notice to any products herein. Motorola makes no warranty, representation or guarantee regarding the suitability of its products for any particular purpose, nor does Motorola assume any liability arising out of the application or use of any product or circuit, and specifically disclaims any and all liability, including without limitation consequential or incidental damages. "Typical" parameters which may be provided in Motorola data sheets and/or specifications can and do vary in different applications and actual performance may vary over time. All operating parameters, including "Typicals" must be validated for each customer application by customer's technical experts. Motorola does not convey any license under its patent rights nor the rights of others. Motorola products are not designed, intended, or authorized for use as components in systems intended for surgical implant into the body, or other applications intended to support or sustain life, or for any other application in which the failure of the Motorola product could create a situation where personal injury or death may occur. Should Buyer purchase or use Motorola products for any such unintended or unauthorized application, Buyer shall indemnify and hold Motorola and its officers, employees, subsidiaries, affiliates, and distributors harmless against all claims, costs, damages, and expenses, and reasonable attorney fees arising out of, directly or indirectly, any claim of personal injury or death associated with such unintended or unauthorized use, even if such claim alleges that Motorola was negligent regarding the design or manufacture of the part. Motorola and  are registered trademarks of Motorola, Inc. Motorola, Inc. is an Equal Opportunity/Affirmative Action Employer.

Mfax is a trademark of Motorola, Inc.

How to reach us:

USA/EUROPE/Locations Not Listed: Motorola Literature Distribution;
 P.O. Box 5405, Denver, Colorado 80217. 303-675-2140 or 1-800-441-2447

JAPAN: Nippon Motorola Ltd.: SPD, Strategic Planning Office, 4-32-1,
 Nishi-Gotanda, Shinagawa-ku, Tokyo 141, Japan. 81-3-5487-8488

Mfax™: RMFAX0@email.sps.mot.com – TOUCHTONE 602-244-6609
 – US & Canada ONLY 1-800-774-1848

ASIA/PACIFIC: Motorola Semiconductors H.K. Ltd.; 8B Tai Ping Industrial Park,
 51 Ting Kok Road, Tai Po, N.T., Hong Kong. 852-26629298

INTERNET: <http://motorola.com/sps>

