

M-Pulse Microwave

Silicon Bipolar MMIC Cascadable Amplifier

MP4TD0670

V4.00

Features

- Cascadable 50Ω Gain Block
- 3dB Bandwidth: DC to 0.8 GHz
- 18.5 dB Typical Gain @ 0.5 GHz
- Unconditionally Stable ($k > 1$)
- Low Voltage Operation
- Hermetic Gold-Ceramic Microstrip Package
- Tape and Reel Packaging Available

Description

M-Pulse's MP4TD0670 is a high performance silicon bipolar MMIC housed in a hermetic high reliability package for surface mount usage. The MP4TD0670 is useful where a general purpose 50Ω gain block with lower (3.0 dB) noise figure is required. Typical applications include narrow and wide band IF and RF amplifiers in industrial and military applications.

The MP4TD0670 is fabricated using a 10 GHz f_T silicon bipolar technology that features gold metalization and IC passivation for increased performance and reliability.

Gold-Ceramic Microstrip Package Outline^{1,2}

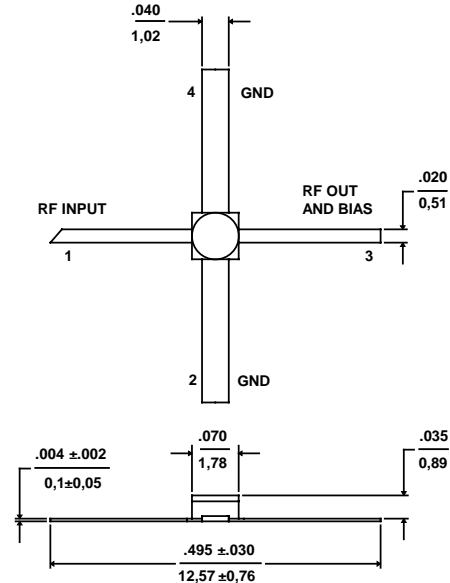

- Notes: (unless otherwise specified)
1. Dimensions are in / mm
 2. Tolerance: in .xxx = ±.005; mm .xx = ±.13

TYPICAL POWER GAIN vs FREQUENCY

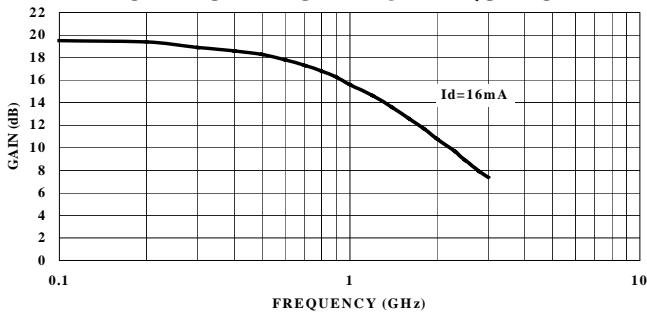

Pin Configuration

Pin Number	Pin Description
1	RF Input
2 & 4	AC/DC Ground
3	RF Output and DC Bias

Ordering Information

Model No.	Package
MP4TD0670	Ceramic
MP4TD0670T	Tape and Reel

Electrical Specifications @ $T_A = +25^\circ\text{C}$, $I_D = 16 \text{ mA}$, $Z_0 = 50\Omega$

Symbol	Parameters	Test Conditions	Units	Min.	Typ.	Max.
G_p	Power Gain ($ S_{21} ^2$)	$f = 0.1 \text{ GHz}$	dB	18.5	19.5	22
ΔG_p	Gain Flatness	$f = 0.1 \text{ to } 0.6 \text{ GHz}$	dB	-	± 0.7	± 1.0
$f_{3 \text{ dB}}$	3 dB Bandwidth	-	GHz	-	0.8	-
SWR_{in}	Input SWR	$f = 0.1 \text{ to } 1.5 \text{ GHz}$	-	-	1.8	-
SWR_{out}	Output SWR	$f = 0.1 \text{ to } 1.5 \text{ GHz}$	-	-	1.8	-
$P_{1 \text{ dB}}$	Output Power @ 1 dB Gain Compression	$f = 0.5 \text{ GHz}$	dBm	-	4.5	-
NF	50 Ω Noise Figure	$f = 0.5 \text{ GHz}$	dB	-	3.0	3.5
IP_3	Third Order Intercept Point	$f = 0.5 \text{ GHz}$	dBm	-	14.5	-
t_D	Group Delay	$f = 0.5 \text{ GHz}$	ps	-	200	-
V_d	Device Voltage	-	V	3.1	3.5	3.9
dV/dT	Device Voltage Temperature Coefficient	-	mV/°C	-	-8.0	-

Specification Subject to Change Without Notice

Absolute Maximum Ratings¹

Parameter	Absolute Maximum
Device Current	50 mA
Power Dissipation ^{2,3}	200 mW
RF Input Power	+20 dBm
Junction Temperature	200°C
Storage Temperature	-65°C to +200°C

Thermal Resistance: $\theta_{jC} = 150^{\circ}\text{C/W}$

1. Exceeding these limits may cause permanent damage.
2. Case Temperature (T_c) = 25 °C.
3. Derate at 6.7 mW/°C for $T_c > 170^{\circ}\text{C}$.

Typical Bias Configuration

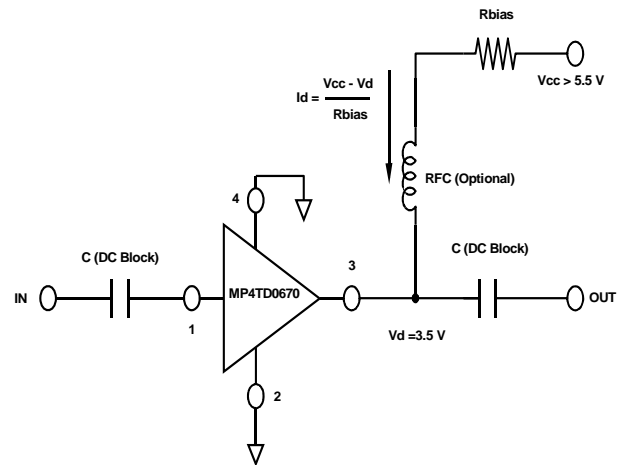

Typical Performance Curves @ $I_d = 16\text{ mA}$, $T_A = +25^{\circ}\text{C}$ (unless otherwise noted)

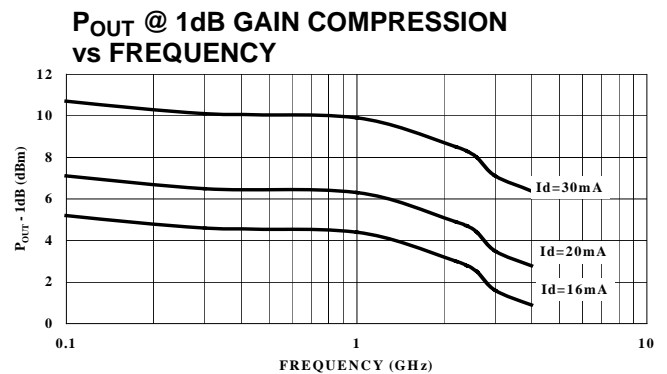
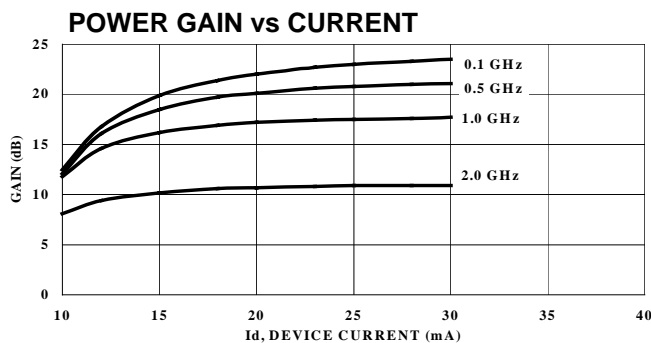
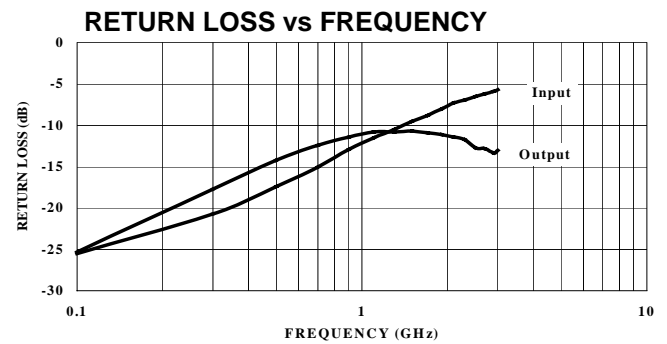
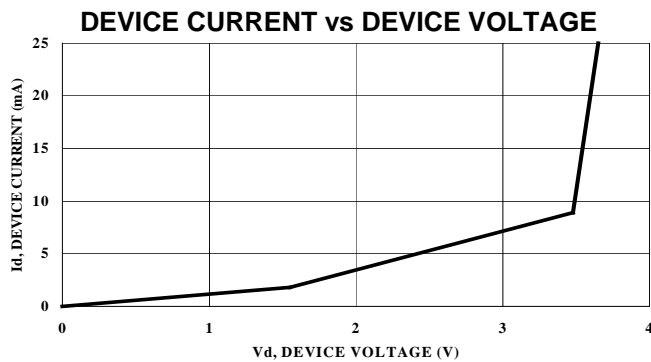

Specification Subject to Change Without Notice

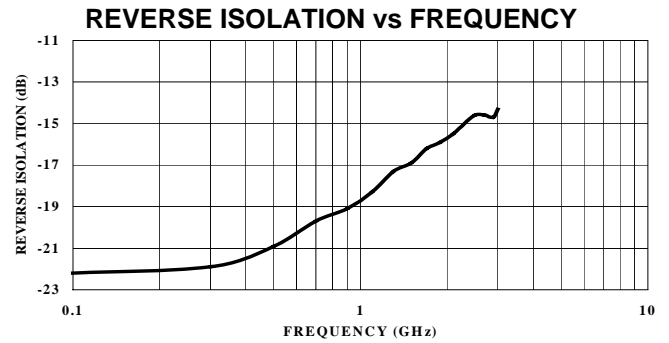
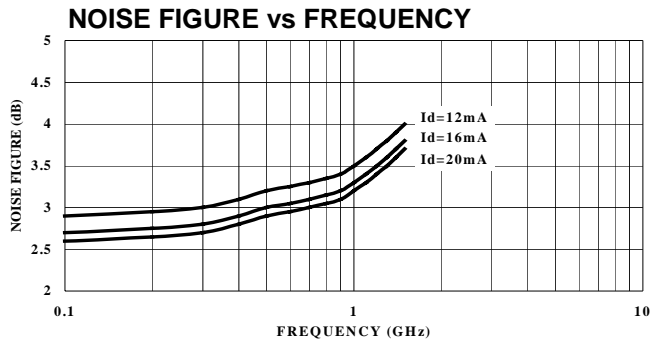

Typical Scattering Parameters

Z₀ = 50Ω, T_A = +25°C, I_D = 16 mA

Frequency (GHz)	S ₁₁		S ₂₁		S ₁₂		S ₂₂	
	Mag.	Angle	Mag.	Angle	Mag.	Angle	Mag	Angle
0.1	0.055	-153.1	9.47	171.0	0.076	5.8	0.053	-55.9
0.2	0.068	-148.6	9.30	162.3	0.077	8.4	0.092	-79.0
0.3	0.094	-134.8	8.90	154.3	0.080	16.3	0.131	-101.8
0.4	0.111	-135.4	8.57	146.3	0.083	20.2	0.165	-113.0
0.5	0.134	-133.4	8.29	138.8	0.089	24.9	0.194	-123.2
0.6	0.156	-138.3	7.78	131.9	0.096	27.3	0.215	-135.2
0.7	0.175	-139.3	7.41	125.1	0.103	28.2	0.237	-142.7
0.8	0.200	-140.2	6.93	119.7	0.106	30.6	0.254	-153.5
0.9	0.224	-143.2	6.54	114.0	0.109	31.2	0.266	-159.7
1.0	0.243	-147.8	6.09	109.0	0.118	33.8	0.277	-167.4
1.5	0.334	-164.4	4.55	87.9	0.143	36.5	0.292	167.5
2.0	0.408	177.9	3.48	73.0	0.163	35.7	0.278	148.9
2.5	0.474	163.1	2.79	60.9	0.183	36.2	0.236	135.8
3.0	0.513	150.8	2.34	52.9	0.191	38.3	0.218	130.1

Specification Subject to Change Without Notice