

M-Pulse Microwave

Silicon Bipolar MMIC Cascadable Amplifier

MP4TD0600

Features

- Cascadable 50Ω Gain Block
- 3dB Bandwidth: DC to 0.8 GHz
- 18.5 dB Typical Gain @ 0.5 GHz
- Unconditionally Stable ($k > 1$)
- Low Voltage Operation

Description

M-Pulse's MP4TD0600 is a high performance silicon bipolar MMIC chip. The MP4TD0600 is designed for use where a general purpose 50Ω gain block is required. Typical applications include narrow and wide band IF and RF amplifiers in industrial and military applications.

The MP4TD0600 is fabricated using a 10 GHz f_T silicon bipolar technology that features gold metalization and IC passivation for increased performance and reliability.

Chip Outline Drawing^{1,2,3,4}

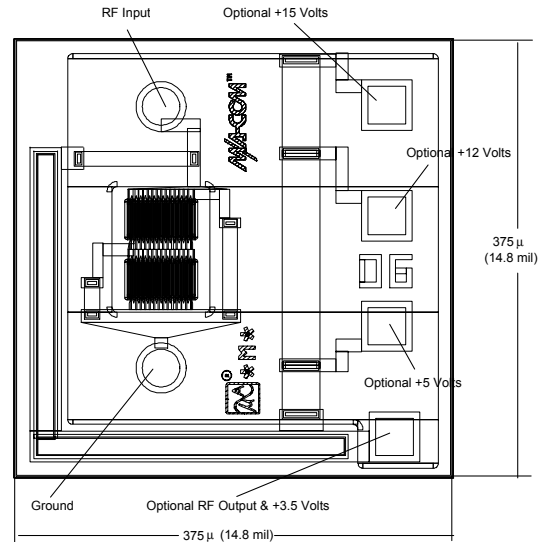

Notes: (unless otherwise specified)

1. Chip Thickness is 120 μm; 4.8 mils
2. Bond Pads are 40 μm; 1.6 mils typical in diameter
3. Output Contact & +DC Voltage Is Normally Made On Backside Of Chip At Die Attach
4. Tolerance: μm .xx = ±.13; mil .x = ±.5

TYPICAL POWER GAIN vs FREQUENCY

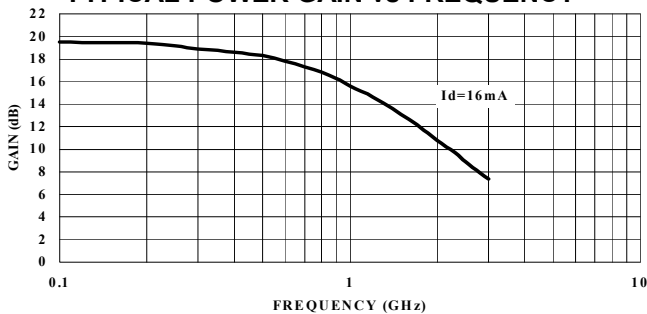

Ordering Information

Model No.	Type of Carrier
MP4TD0600G	GEL PACK
MP4TD0600W	Waffle Pack

Electrical Specifications @ $T_A = +25^\circ\text{C}$, $I_d = 16 \text{ mA}$, $Z_0 = 50\Omega$

Symbol	Parameters	Test Conditions	Units	Min.	Typ.	Max.
G_p	Power Gain ($ S_{21} ^2$)	$f = 0.1 \text{ GHz}$	dB	-	20.0	-
ΔG_p	Gain Flatness	$f = 0.1 \text{ to } 0.6 \text{ GHz}$	dB	-	±0.7	-
f_{3dB}	3 dB Bandwidth	-	GHz	-	0.8	-
SWR_{in}	Input SWR	$f = 0.1 \text{ to } 1.5 \text{ GHz}$	-	-	2.0	-
SWR_{out}	Output SWR	$f = 0.1 \text{ to } 2.0 \text{ GHz}$	-	-	1.8	-
P_{1dB}	Output Power @ 1 dB Gain Compression	$f = 0.5 \text{ GHz}$	dBm	-	3.0	-
NF	50 Ω Noise Figure	$f = 0.5 \text{ GHz}$	dB	-	3.0	-
IP_3	Third Order Intercept Point	$f = 0.5 \text{ GHz}$	dBm	-	14.5	-
t_D	Group Delay	$f = 0.5 \text{ GHz}$	ps	-	200	-
V_d	Device Voltage	-	V	3.1	3.5	3.9
dV/dT	Device Voltage Temperature Coefficient	-	mV/°C	-	-8.0	-

Specification Subject to Change Without Notice

M-Pulse Microwave

1

PH (408) 432-1480 FX (408) 432-3440

Absolute Maximum Ratings¹

Parameter	Absolute Maximum
Device Current	50 mA
Power Dissipation ^{2,3}	200 mW
RF Input Power	+20 dBm
Junction Temperature	200°C
Storage Temperature	-65°C to +200°C
Thermal Resistance: $\theta_{jc} = 50^\circ\text{C/W}$	

1. Exceeding these limits may cause permanent damage.
2. Case Temperature (T_c) = 25 °C.
3. Derate for at 20 mW/°C for $T_c > 190^\circ\text{C}$.

Typical Bias Configuration

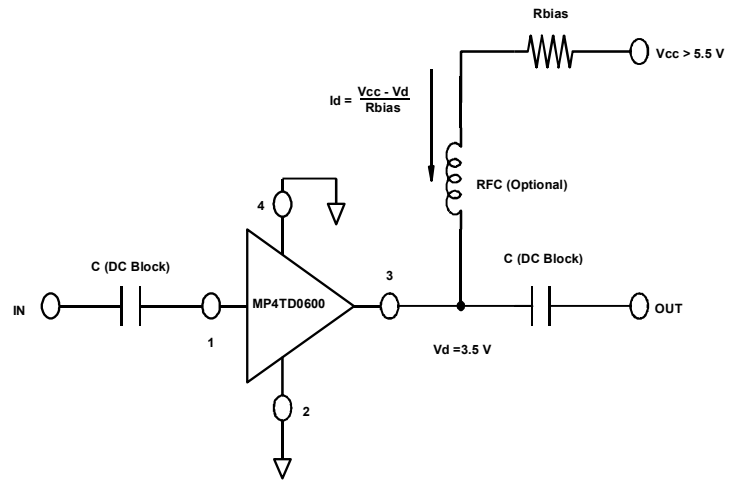

Typical Performance Curves @ $I_d = 16\text{ mA}$, $T_A = +25^\circ\text{C}$ (unless otherwise noted)

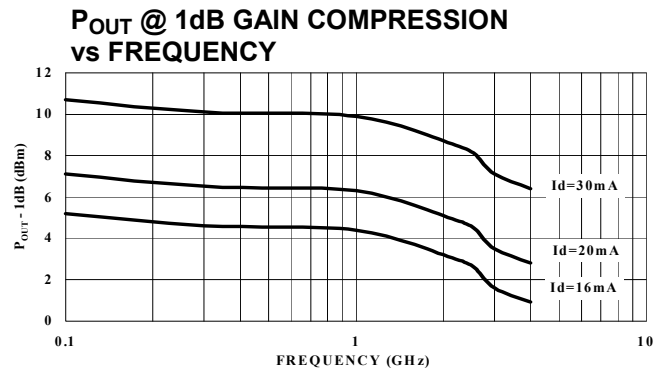
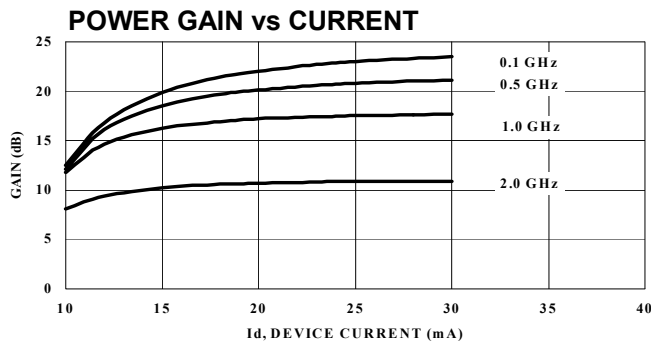
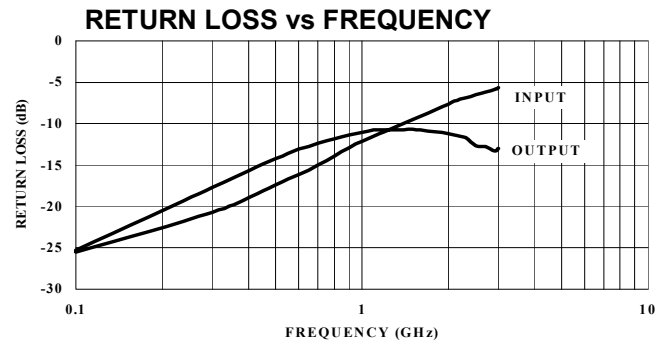
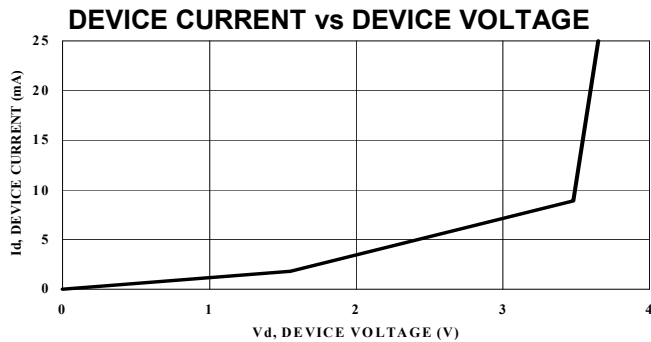

Specification Subject to Change Without Notice

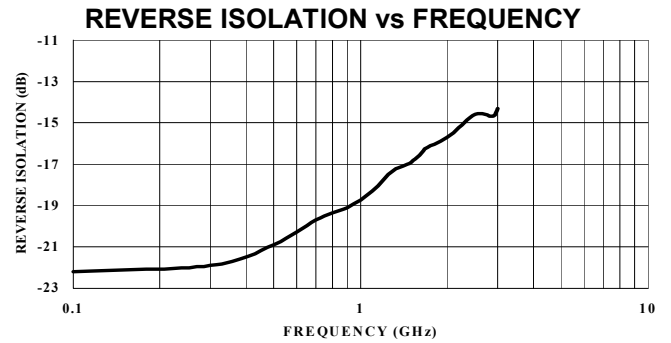
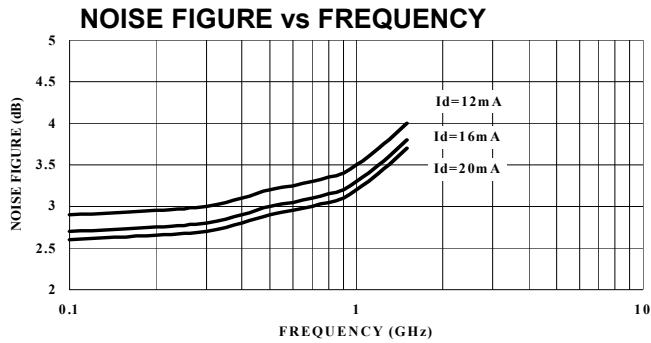

Typical Scattering Parameters

Z₀ = 50Ω, T_A = +25°C, I_D = 16 mA

Frequency (GHz)	S ₁₁		S ₂₂		S ₁₂		S ₂₁	
	Mag.	Angle	Mag.	Angle	Mag.	Angle	Mag.	Angle
0.1	0.055	-153.1	9.47	171.0	0.076	5.8	0.053	-55.9
0.2	0.068	-148.6	9.30	162.3	0.077	8.4	0.092	-79.0
0.3	0.094	-134.8	8.90	154.3	0.080	16.3	0.131	-101.8
0.4	0.111	-135.4	8.57	146.3	0.083	20.2	0.165	-113.0
0.5	0.134	-133.4	8.29	138.8	0.089	24.9	0.194	-123.2
0.6	0.156	-138.3	7.78	131.9	0.096	27.3	0.215	-135.2
0.7	0.175	-139.3	7.41	125.1	0.103	28.2	0.237	-142.7
0.8	0.200	-140.2	6.93	119.4	0.106	30.6	0.254	-153.5
0.9	0.224	-143.2	6.54	114.0	0.109	31.2	0.266	-159.7
1.0	0.243	-147.8	6.09	109.0	0.118	33.8	0.277	-167.4
1.5	0.334	-164.4	4.55	87.9	0.143	36.5	0.292	167.5
2.0	0.408	177.9	3.48	73.0	0.163	35.7	0.278	148.9
2.5	0.474	163.1	2.79	60.9	0.183	36.2	0.236	135.8
3.0	0.513	150.8	2.34	52.9	0.191	38.3	0.218	130.1

Specification Subject to Change Without Notice