

Silicon Bipolar High f_T Low Noise Microwave Transistors

MP4T645

Features

- f_T to 9 GHz
- Low Noise Figure
- High Associated Gain
- Hermetic and Surface Mount Packages Available
- Can be Screened to JANTX, JANTXV Equivalent Levels
- Industry Standard

Description

The MP4T645 family of high gain-bandwidth, small signal silicon bipolar transistors is well suited for use in amplifiers to approximately 4 GHz, and in oscillators to approximately 10 GHz. These industry standard transistors feature low noise figure at high collector current, which produces very good associated gain and wide dynamic range. The MP4T645 series transistors are available in a hermetic microstrip package (MP4T64535), in the plastic SOT-23 package (MP4T64533), in chip form (MP4T64500), and in the SOT-143 package (MP4T64539). The MP4T645 series is available in other plastic and hermetic packages as well. The chip and hermetically packaged transistors can be screened to a JANTXV equivalent level.

Applications

The MP4T645 family of bipolar NPN transistors can be used for low noise, high associated gain, large dynamic range amplifiers up to approximately 4 GHz. These transistors can also be used as preamplifier or driver stages in the same frequency range.

The MP4T645 family of bipolar NPN transistors can also be used for oscillators or VCOs up to approximately 10 GHz. The passivation consists of silicon dioxide, commonly known as thermal oxide, and silicon nitride to produce very low $1/f$ noise in both amplifiers and oscillators.

Case Styles

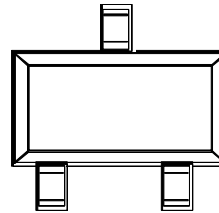

SOT-23

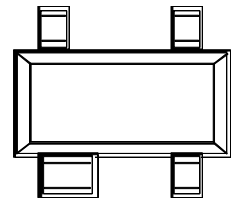

SOT-143

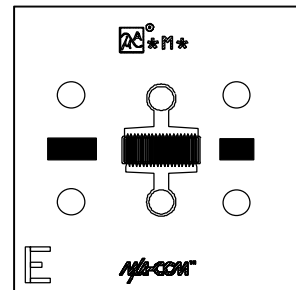

Chip

Micro-X

Specification Subject to Change Without Notice

Absolute Maximum Ratings

MP4T645 Series

Collector-Base Voltage	V_{CBO}	25 V
Collector-Emitter Voltage	V_{CEO}	12 V
Emitter-Base Voltage	V_{EBO}	1.5 V
Collector Current	I_C	65 mA
Junction Operating Temperature	T_j	200°C
Storage Temperature Chip or Ceramic Packages Plastic Packages		-65°C to +200°C -65°C to +125°C
Total Power Dissipation at 25°C Derate Linearly to:		
+150°C Chip		400 mW
+125°C Plastic Package (SOT-23)		200 mW
+150°C Ceramic Package (Micro-X)		300 mW

Electrical Specifications @ 25°C

MP4T645 Series

Parameter of Test	Condition	Symbol	Units	MP4T64500 Chip	MP4T64535 SOT-23	MP4T64533 Micro-X
Gain Bandwidth Product	$V_{CE} = 8$ volts $I_C = 20$ mA	f_T	GHz	10 typ	8 typ	9 typ
Insertion Power Gain	$V_{CE} = 8$ volts $I_C = 20$ mA $f = 1$ GHz $f = 2$ GHz $f = 4$ GHz	$ S_{21E} ^2$	dB	18 typ 11 min 7 typ	16 typ 10 min	17 typ 10 min 6.5 typ
Noise Figure	$V_{CE} = 8$ volts $I_C = 7$ mA $f = 1$ GHz $f = 2$ GHz	NF	dB	1.7 max 2.0 typ	1.7 max 2.5 typ	1.7 max 2.0 typ
Unilateral Gain	$V_{CE} = 8$ volts $I_C = 7$ mA $f = 1$ GHz $f = 2$ GHz	GTU (max)	dB	18 typ 11 typ	16 typ 10 typ	17 typ 11 typ
Maximum Available Gain	$V_{CE} = 8$ volts $I_C = 10$ mA $f = 2$ GHz $f = 4$ GHz	MAG	dB	14 typ 12 typ	13 typ 10 typ	14 typ 11.5 typ
Power Out at 1 dB Compression	$V_{CE} = 8$ volts $I_C = 10$ mA $f = 1$ GHz $f = 4$ GHz	P_{1dB}	dBm	16 typ 11 typ	16 typ 11 typ	16 typ 11 typ

Note: The electrical characteristics of the MP4T64539 (SOT-143) are very similar to those of the MP4T64533 (SOT-23).

Specification Subject to Change Without Notice

M-Pulse Microwave

576 Charcot Avenue, San Jose, California 95131

Tel (408) 432-1480

Fax (408) 432-3440

Electrical Specifications @ 25°C

MP4T645 Series

Parameter	Condition	Symbol	Min	Typical	Max	Units
Collector Cut-off Current	$V_{CB} = 8$ volts $I_E = 0$ μ A	I_{CBO}	—	—	100	nA
Emitter Cut-off Current	$V_{EB} = 1$ volt $I_C = 0$ μ A	I_{EBO}	—	—	1	μ A
Forward Current Gain	$V_{CE} = 8$ volts $I_C = 7$ mA	h_{FE}	30	125	250	—
Collector-Base Junction Capacitance	$V_{CB} = 10$ volts $I_E = 0$ μ A $f = 1$ MHz	C_{CO}	—	0.3	0.6	pF

Typical Scattering Parameters in the Micro-X Package

MP4T64535, $V_{CE} = 8$ Volts, $I_C = 7$ mA

Frequency (MHz)	S_{11E}		S_{21E}		S_{12E}		S_{22E}	
	Mag.	Angle	Mag.	Angle	Mag.	Angle	Mag.	Angle
500	0.583	-114	9.315	116.1	0.052	43.6	0.573	-42.6
1000	0.569	-153	5.399	94.7	0.063	39.0	0.406	-53.0
1500	0.573	-173	3.807	82.0	0.072	40.0	0.357	-57.1
2000	0.587	170	2.980	72.0	0.082	42.5	0.313	-61.8
2500	0.598	159	2.479	62.7	0.092	44.0	0.299	-71.7
3000	0.616	150	2.132	54.8	0.103	45.2	0.304	-78.5
3500	0.645	142	1.935	47.0	0.118	45.5	0.289	-86.5
4000	0.675	132	1.782	38.5	0.130	45.7	0.281	-96.6
4500	0.705	124	1.631	29.6	0.143	45.5	0.292	-105.5
5000	0.749	115	1.538	22.0	0.159	44.5	0.281	-114.1
5500	0.791	106	1.445	14.4	0.176	43.6	0.283	-125.7
6000	0.832	96	1.395	6.1	0.188	42.3	0.306	-135.0

MP4T64535, $V_{CE} = 8$ Volts, $I_C = 10$ mA

Frequency (MHz)	S_{11E}		S_{21E}		S_{12E}		S_{22E}	
	Mag.	Angle	Mag.	Angle	Mag.	Angle	Mag.	Angle
500	0.562	-128	10.477	111.9	0.044	44.5	0.515	-46.2
1000	0.564	-161	5.845	92.1	0.056	44.0	0.358	-53.8
1500	0.575	176	4.088	80.5	0.068	46.5	0.313	-57.2
2000	0.592	166	3.185	70.9	0.080	49.0	0.276	-62.3
2500	0.601	156	2.638	62.0	0.092	49.7	0.268	-71.7
3000	0.618	148	2.266	54.5	0.105	50.1	0.272	-78.3
3500	0.648	139	2.053	46.9	0.122	49.4	0.259	-87.0
4000	0.677	130	1.892	38.6	0.136	48.7	0.253	-96.9
4500	0.706	122	1.734	29.8	0.150	47.9	0.264	-106.0
5000	0.749	113	1.634	22.3	0.167	46.1	0.257	-115.1
5500	0.790	104	1.532	14.8	0.184	44.4	0.259	-126.3
6000	0.831	95	1.482	6.4	0.196	42.6	0.278	-136.0

Specification Subject to Change Without Notice

M-Pulse Microwave

576 Charcot Avenue, San Jose, California 95131

Tel (408) 432-1480

Fax (408) 432-3440

Typical Scattering Parameters in the Micro-X Package (Cont'd)

MP4T64535, $V_{CE} = 8$ Volts, $I_C = 20$ mA

Frequency (MHz)	S _{11E}		S _{21E}		S _{12E}		S _{22E}	
	Mag.	Angle	Mag.	Angle	Mag.	Angle	Mag.	Angle
500	0.536	-154	11.788	104.0	0.033	49.8	0.390	-46.8
1000	0.565	-177	6.309	87.5	0.046	55.7	0.284	-53.2
1500	0.579	170	4.350	77.0	0.062	57.7	0.270	-54.6
2000	0.592	160	3.368	68.6	0.077	59.3	0.237	-57.5
2500	0.612	151	2.798	60.1	0.093	58.0	0.226	-70.0
3000	0.630	142	2.390	52.6	0.108	56.5	0.243	-77.2
3500	0.660	134	2.156	45.4	0.126	54.4	0.231	-84.4
4000	0.691	125	1.984	37.2	0.141	52.6	0.223	-95.8
4500	0.719	117	1.809	28.4	0.155	50.9	0.240	-105.2
5000	0.760	109	1.697	21.3	0.173	48.5	0.229	-112.6
5500	0.803	101	1.594	13.8	0.192	46.0	0.229	-112.3
6000	0.844	92	1.540	6.0	0.210	44.2	0.258	-136.2

Typical Scattering Parameters in the SOT-23 Package

MP4T64533, $V_{CE} = 8$ Volts, $I_C = 7$ mA

Frequency (MHz)	S _{11E}		S _{21E}		S _{12E}		S _{22E}	
	Mag.	Angle	Mag.	Angle	Mag.	Angle	Mag.	Angle
500	0.421	-95	7.378	126.4	0.062	77.9	0.519	-36.3
1000	0.257	-149	4.384	118.9	0.100	97.9	0.402	-36.9
1500	0.232	-176	3.082	123.3	0.140	116.2	0.368	-39.6
2000	0.238	157	2.408	129.2	0.183	130.9	0.354	-44.7
2500	0.256	140	2.005	136.3	0.224	145.7	0.346	-51.6
3000	0.279	126	1.734	143.2	0.274	160.8	0.339	-58.8
3500	0.310	116	1.498	153.3	0.308	172.0	0.331	-68.5
4000	0.338	106	1.367	163.5	0.350	173.6	0.320	-80.1
4500	0.359	97	1.284	173.8	0.402	161.0	0.327	-90.6

MP4T64533, $V_{CE} = 8$ Volts, $I_C = 10$ mA

Frequency (MHz)	S _{11E}		S _{21E}		S _{12E}		S _{22E}	
	Mag.	Angle	Mag.	Angle	Mag.	Angle	Mag.	Angle
500	0.299	-116	8.385	119.4	0.057	82.1	0.451	-33.9
1000	0.216	-161	4.558	116.9	0.099	102.3	0.354	-33.2
1500	0.215	172	3.185	122.7	0.142	119.5	0.332	-37.7
2000	0.230	151	2.487	129.0	0.188	132.9	0.332	-44.0
2500	0.247	134	2.064	136.4	0.230	146.9	0.332	-50.1
3000	0.267	123	1.783	143.8	0.281	161.5	0.322	-56.1
3500	0.299	114	1.548	153.9	0.315	172.5	0.310	-66.4
4000	0.328	104	1.410	164.0	0.357	173.6	0.299	-79.2
4500	0.352	96	1.320	174.5	0.408	161.3	0.310	-90.1

Specification Subject to Change Without Notice

M-Pulse Microwave

576 Charcot Avenue, San Jose, California 95131

MP4T645 Series
Typical Performance Curves

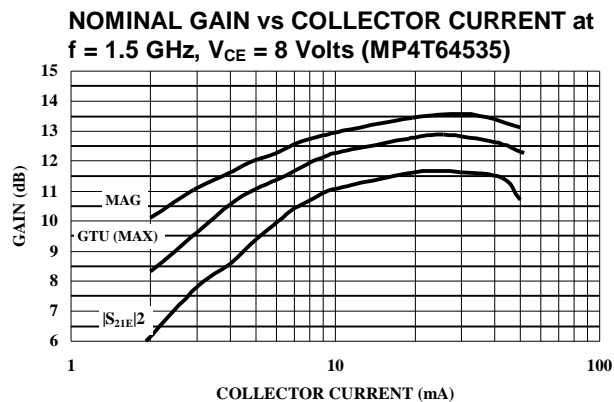
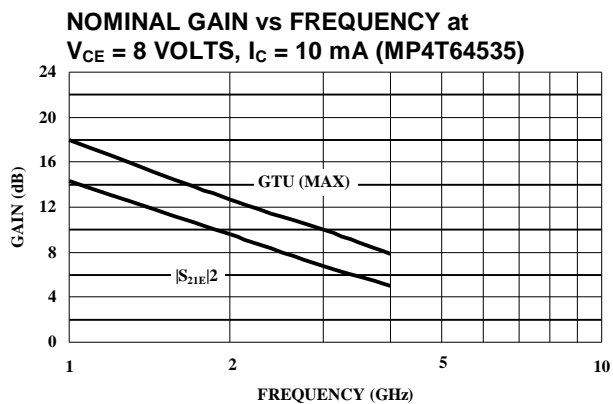
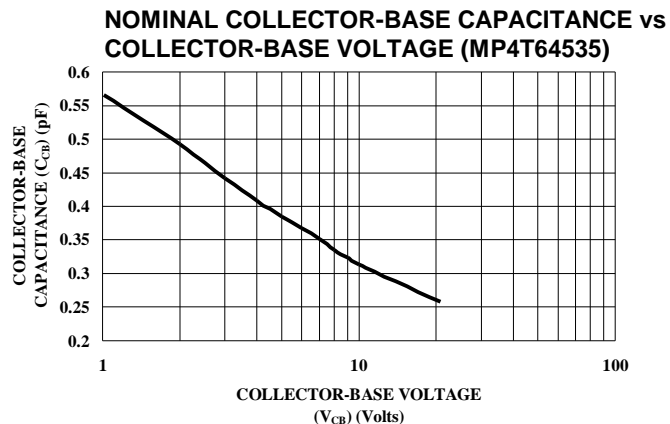
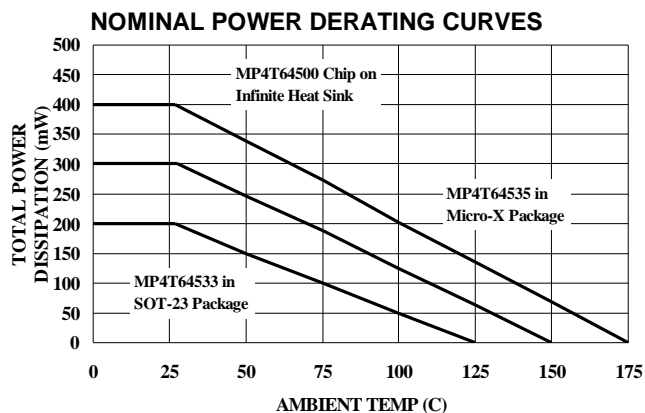

Specification Subject to Change Without Notice

Typical Performance Curves (Cont'd)

NOMINAL GAIN BANDWIDTH PRODUCT vs COLLECTOR CURRENT (MP4T64535)

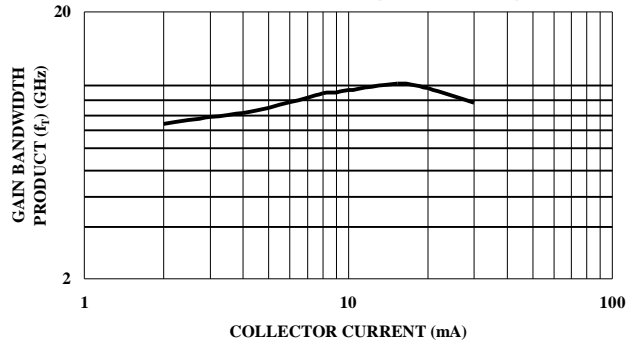

NOMINAL DC CURRENT GAIN vs COLLECTOR CURRENT at $V_{CE} = 8$ VOLTS (MP4T64535)

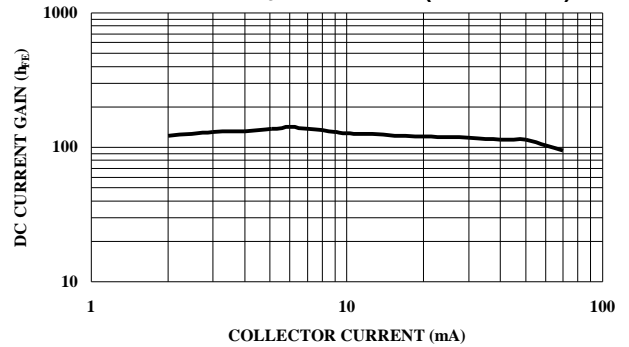

NOMINAL NOISE FIGURE and ASSOCIATED GAIN vs FREQUENCY at $V_{CE} = 8$ VOLTS, COLLECTOR CURRENT = 7 mA (MP4T64535)

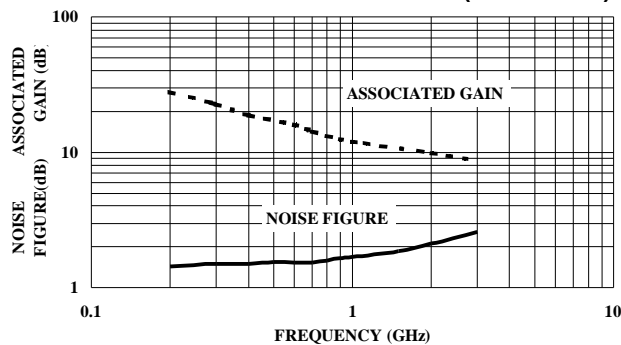

NOMINAL NOISE FIGURE and ASSOCIATED GAIN vs COLLECTOR CURRENT at $f = 1$ GHz and $V_{CE} = 8$ VOLTS (MP4T64535)

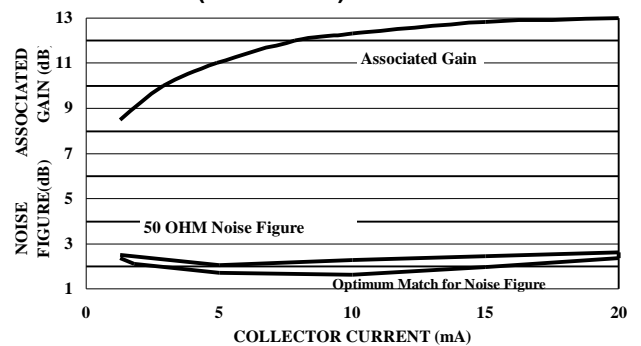

Specification Subject to Change Without Notice

Typical Performance Curves (Cont'd)

NOMINAL OUTPUT POWER at the 1dB COMPRESSION POINT vs COLLECTOR CURRENT at $f = 1$ and 4 GHz, $V_{CE} = 8$ VOLTS (MP4T64535)

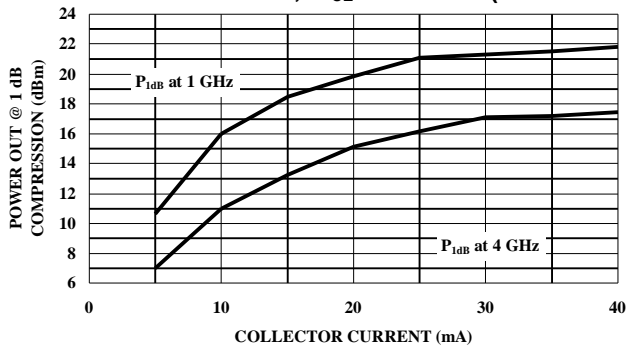

Case Styles

MP4T64533
SOT-23

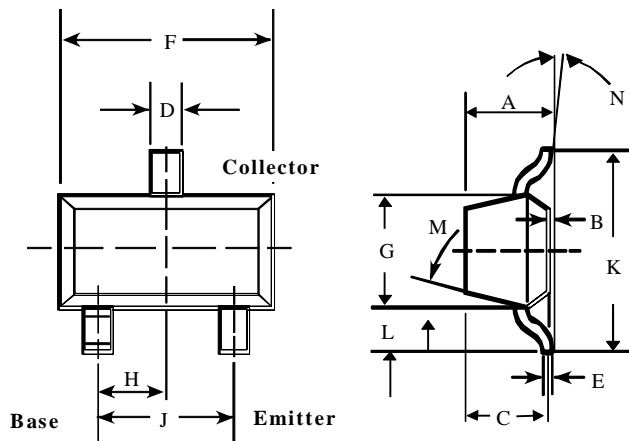

MP4T64533

DIM.	INCHES		MILLIMETERS	
	MIN.	MAX.	MIN.	MAX.
A	—	0.044	—	1.12
B	—	0.004	—	0.10
C	—	0.040	—	1.00
D	0.013	0.020	0.35	0.50
E	0.003	0.006	0.08	0.15
F	0.110	0.119	2.80	3.00
G	0.047	0.056	1.20	1.40
H	0.037 typical		0.95 typical	
J	0.075 typical		1.90 typical	
K	—	0.103	—	2.60
L	—	0.024	—	0.60

DIM.	GRADIENT
M	10° max. ¹
N	2° ... 30°

NOTE:
1. Applicable on all sides

Specification Subject to Change Without Notice

Case Styles (Cont'd)

MP4T64535 Micro-X

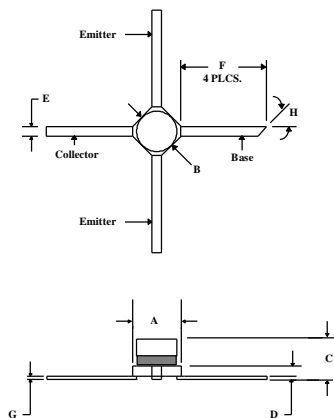

MP4T64535

DIM.	INCHES		MILLIMETERS	
	MIN.	MAX.	MIN.	MAX.
A	0.092	0.108	2.34	2.74
B	0.079	0.087	2.01	2.21
C	—	0.070	—	1.78
D	0.019	0.025	0.48	0.64
E	0.018	0.022	0.46	0.56
F	0.150	—	3.81	—
G	0.003	0.006	0.08	0.15
H	45°		45°	

MP4T64500
Case Style 00 (Chip)

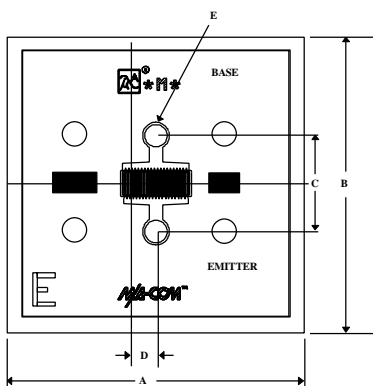

MP4T64500

DIM.	INCHES	MILLIMETERS
A	0.013	0.325
B	0.013	0.325
C	0.004	0.110
D	0.0005	0.013
E (Dia.)	0.0012	0.030
F (chip thickness)	0.0045	0.114

MP4T64539
Case Style SOT-143

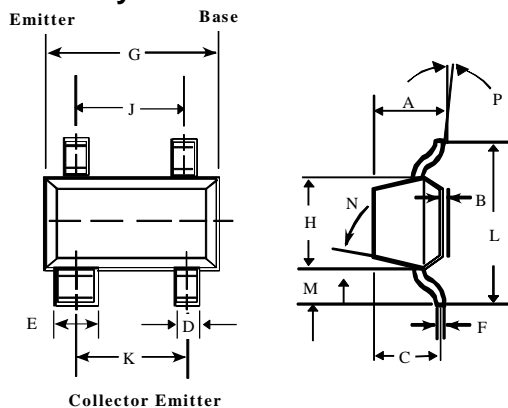

MP4T64539

DIM.	INCHES		MILLIMETERS	
	MIN.	MAX.	MIN.	MAX.
A	—	0.044	—	1.10
B	—	0.004	—	0.10
C	—	0.040	—	1.00
D	0.013	0.020	0.35	0.50
E	0.030	0.035	0.75	0.90
F	0.003	0.006	0.08	0.15
G	0.110	0.119	2.80	3.00
H	0.047	0.056	1.20	1.40
J	0.075 typical		1.90 typical	
K	0.040 typical		1.70 typical	
L	—	0.103	—	2.60
M	—	0.024	—	0.60

DIM.	GRADIENT
N	10° max. ¹
P	2° . . . 30°

NOTE:
1. Applicable on all sides

Specification Subject to Change Without Notice

M-Pulse Microwave
576 Charcot Avenue, San Jose, California 95131