



The Future of Analog IC Technology®

EV0033 (MP1567) 1.2A, 6V, 800KHz Synchronous Rectified Step-Down Converter

EVALUATION BOARD

GENERAL DESCRIPTION

The MP1567 is a 1.2A, 800KHz DC to DC converter designed for low voltage applications requiring high efficiency. Capable of providing output voltages as low as 0.9V from a 3.3V supply voltage, the MP1567 eliminates the need for a 5V rail, providing over 90% efficiency via synchronous rectification and eliminating heat issues in confined spaces. Soft-start operation protects internal circuitry from hard turn on issues. Switching at 800KHz reduces the size of external components and thereby reduces board space.

The MP1567 includes cycle-by-cycle current limiting and under voltage lockout. Internal power switches combined with the tiny 10-pin MSOP or QFN packages provide a solution requiring a minimum of space.

ELECTRICAL SPECIFICATIONS

Parameter	Symbol	Value	Units
Input Voltage	V_{IN}	2.6 to 6	V
Output Voltage	V_{OUT}	1.8	V
Output Current	I_{OUT}	1.2	A

FEATURES

- 1.2A Output Current
- Synchronous Rectified
- Internal 180mΩ and 220mΩ Power Switches
- V_{IN} Range of 2.6V to 6V
- Over 90% Efficiency
- Zero Current Shutdown Mode
- Under Voltage Lockout Protection
- Soft-Start Operation
- Thermal Shutdown
- Internal Current Limit (Source & Sink)
- Tiny 10-Pin MSOP Package

APPLICATIONS

- SOHO Routers, PCMCIA Cards, Mini PCI
- Handheld Computers, PDAs
- Cell Phones
- Digital Video Cameras
- Small LCD Displays

"MPS" and "The Future of Analog IC Technology" are Registered Trademarks of Monolithic Power Systems, Inc.

EV0033 EVALUATION BOARD

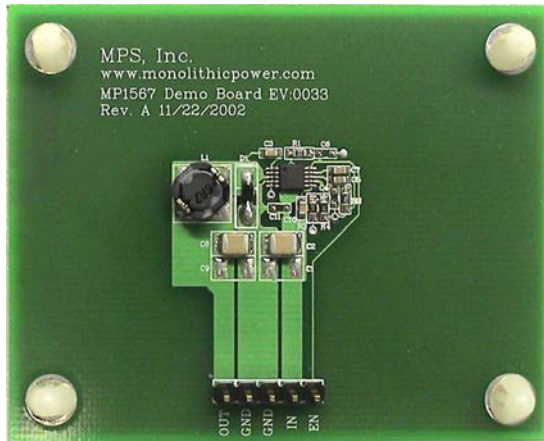

Dimensions (2.5"X x 2.0"Y x 0.4"Z)

Board Number	MPS IC Number
EV0033	MP1567DK

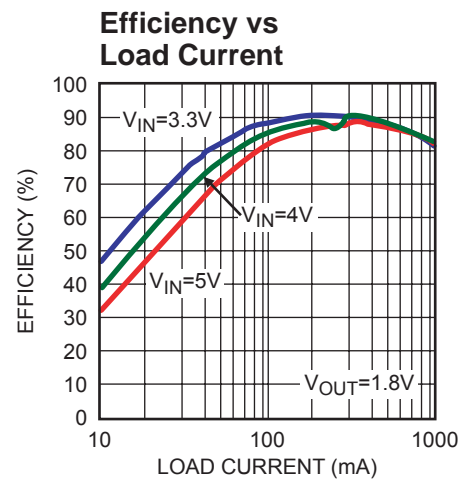

EVALUATION BOARD SCHEMATIC

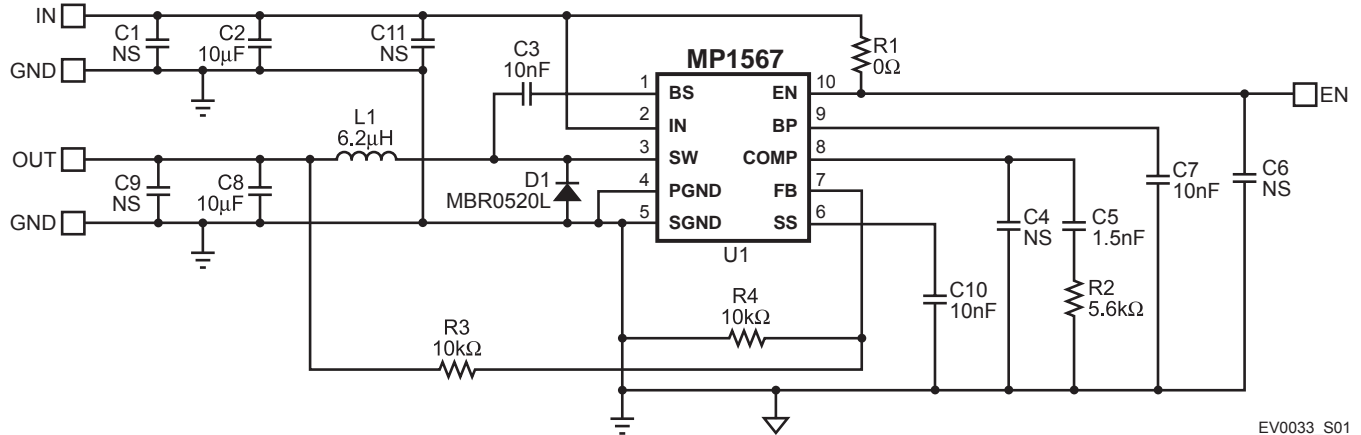

EV0033_S01

EV0033 BILL OF MATERIALS

Qty	Ref	Value	Description	Package	Manufacturer P/N	Distributor P/N
5	C1, C4, C6, C9, C11	NS	Not Stuffed			
2	C2, C8	10µF	Capacitor			
3	C3, C7, C10	10nF	Capacitor			
1	C5	1.5nF	Capacitor			
1	D1		Diode		MBR0520L	
1	L1	6.2µH	Inductor		Sumida CDRH5D18	
1	R1	0Ω				
	R2	5.6kΩ	Resistor			
	R3, R4	10kΩ	Resistor, 1%			
	U1		Step-Down Converter	MSOP10	MPS MP1567DK	

PRINTED CIRCUIT BOARD LAYOUT

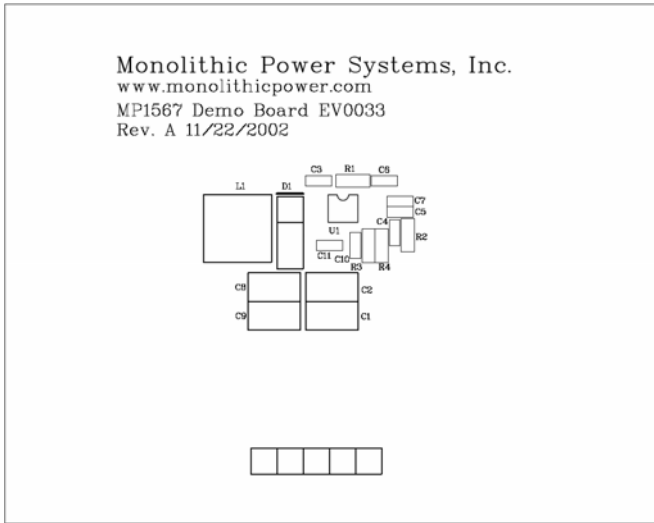

Figure 1—Top Silk Layer

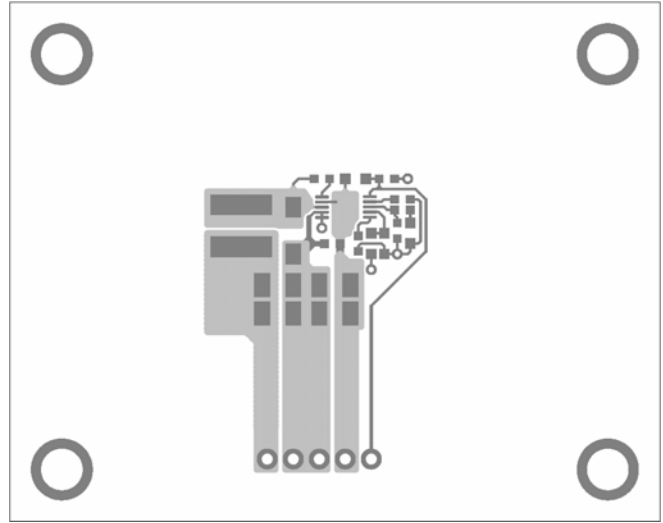

Figure 2—Top Layer

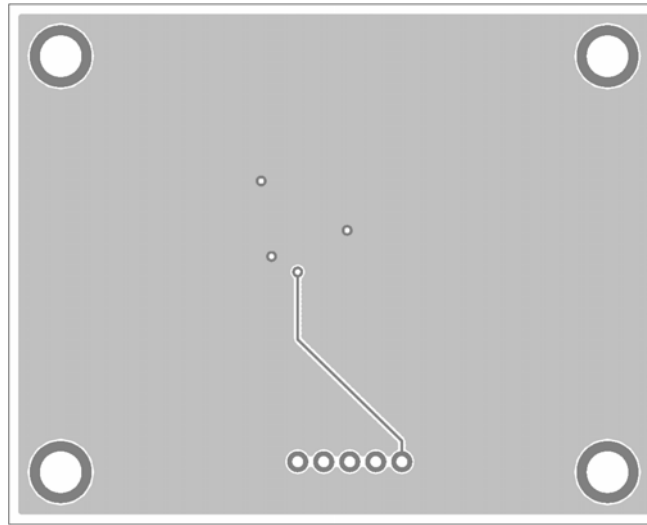
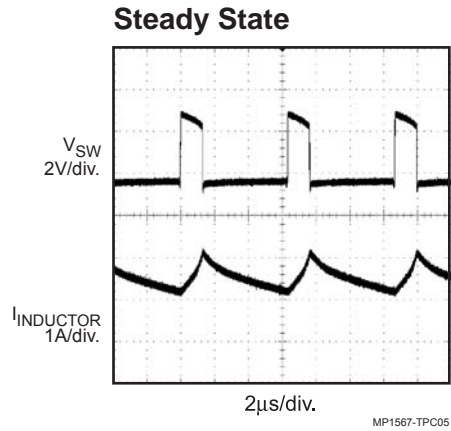
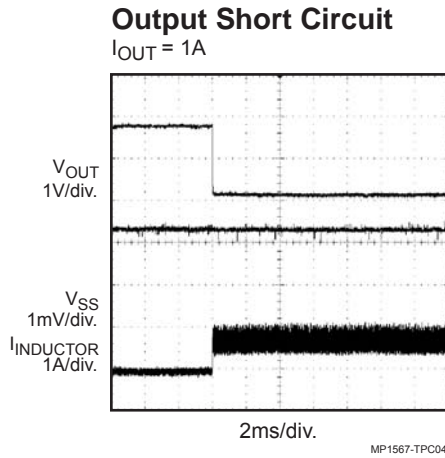
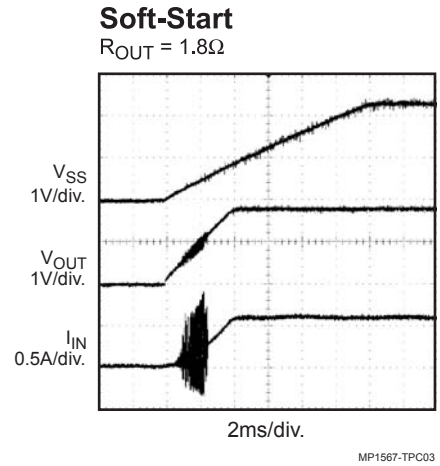
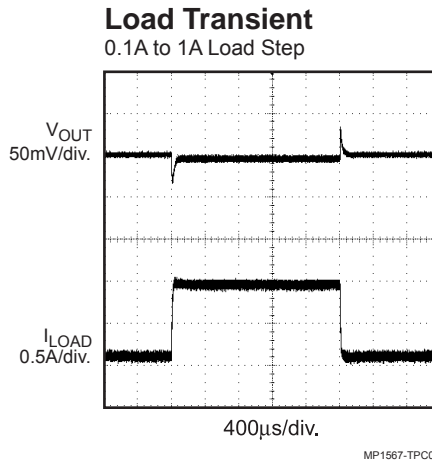
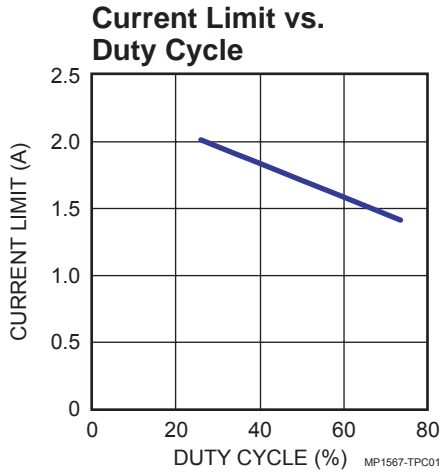

Figure 3—Bottom Layer

TYPICAL PERFORMANCE CHARACTERISTICS

$V_{IN} = 3.3V$, $V_{OUT} = 1.8V$, $T_A = +25^{\circ}C$, unless otherwise noted.



QUICK START GUIDE

The output voltage of this board is set to 1.8V. The board layout accommodates most commonly used inductors and output capacitors.

1. Attach the positive and negative ends of the load to the OUT and GND pins respectively.
2. Attach an input voltage $2.6V \leq V_{IN} \leq 6V$ and the input ground to the IN and GND pins, respectively.
3. To enable the MP1567 apply a voltage, $2V \leq V_{EN} \leq 6V$, to the EN pin. To disable the MP1567 connect the EN pin to ground.
4. The output voltage V_{OUT} can be changed by varying R3. Calculate the new value using the formula:

$$R3 = R4 \times \left(\frac{V_{OUT}}{V_{FB}} - 1 \right)$$

Where $V_{FB} = 0.9V$ and $R4 = 10k\Omega$.

For example, for $V_{OUT} = 2.5V$:

$$R3 = R4 \times \left(\frac{V_{OUT}}{V_{FB}} - 1 \right) = 10k\Omega \times \left(\frac{2.5V}{0.9V} - 1 \right) = 17.78k\Omega$$

Therefore use a standard 1% value 17.8k Ω resistor.

Note: See Maximum Duty Cycle limits to determine allowable output voltages.

NOTICE: The information in this document is subject to change without notice. Please contact MPS for current specifications. Users should warrant and guarantee that third party Intellectual Property rights are not infringed upon when integrating MPS products into any application. MPS will not assume any legal responsibility for any said applications.