

Metallized Polyester Film Capacitors MKT Radial Potted Type

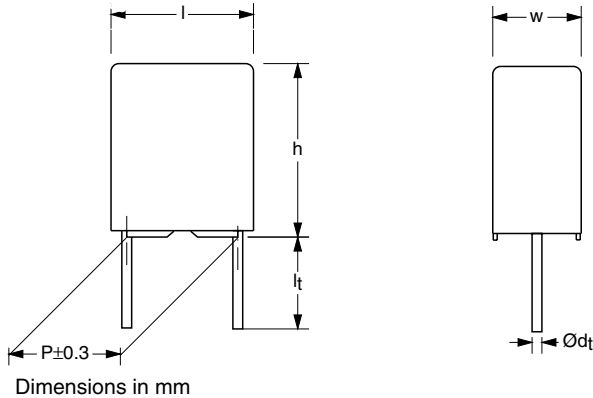

APPLICATIONS

Blocking, coupling and decoupling. Bypass and energy reservoir

MARKING

C-value; tolerance; rated voltage; year and week of manufacturer; manufacturer's type designation

DIELECTRIC

Polyester film

ELECTRODES

Vacuum deposited aluminum

ENCAPSULATION

Flame retardant plastic case and epoxy resin (UL-class 94 V-0)

CONSTRUCTION

Wound mono construction

LEADS

Tinned wire

CAPACITANCE TOLERANCE

±10%; ±5%

FEATURES

Pitch 5 mm available loose in box, ammpack and taped on reel.

Lead (Pb)-free product

RoHS-compliant product



RoHS
COMPLIANT

CAPACITANCE RANGE (E12 SERIES)

0.001 to 1.2 μ F

RATED (DC) VOLTAGE

63 V; 100 V; 250 V; 400 V

RATED (AC) VOLTAGE

40 V; 63 V; 160 V; 200 V

CLIMATIC CATEGORY

55/125/56

RATED TEMPERATURE

85 °C

MAXIMUM APPLICATION TEMPERATURE

125 °C

REFERENCE SPECIFICATIONS

IEC 60384-2

PERFORMANCE GRADE

Grade 1 (long life)

DETAIL SPECIFICATION

For more detailed data and test requirements see "Type detail specification HQN-384-02/104"



COMPOSITION OF CATALOG NUMBER

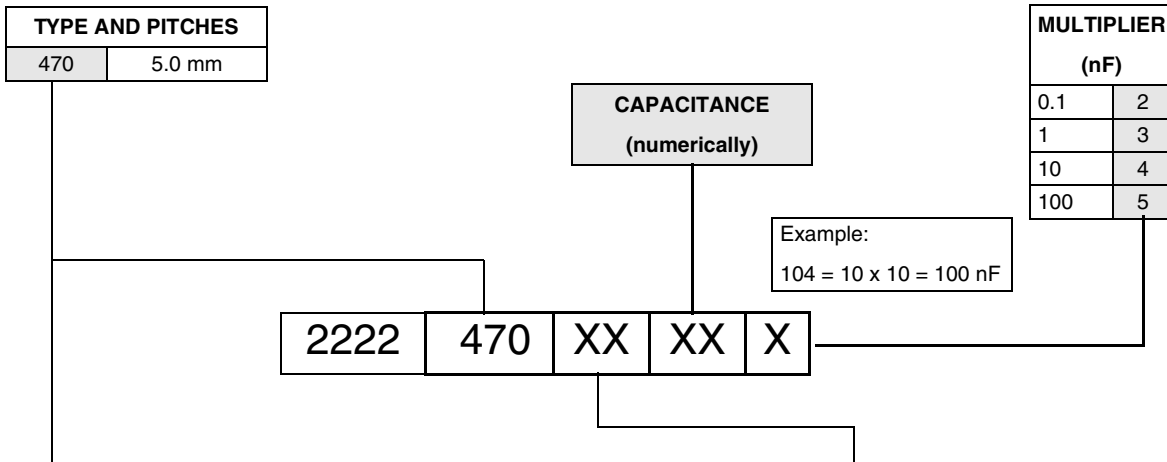

TYPE	PACKAGING	LEAD CONFIGURATION	PREFERRED TYPES				
			C-TOL	63 V	100 V	250 V	400 V
470	ammopack	H = 18.5 mm; P ₀ = 12.7 mm	±10%	75	85	35	65
			±5%	76	86	36	66
			ON REQUEST				
470	loose in box	lead length 4.0 +1.0/-0.5 mm	±10%	11	21	41	51
			±5%	12	22	42	52
	taped on reel	lead length 26.0 ±2.0 mm	±10%	15	25	45	55
			±5%	16	26	46	56
	H = 18.5 mm; P ₀ = 12.7 mm; reel diameter 356 mm	±10%	18	28	48	58	
		±5%	19	29	49	59	

SPECIFIC REFERENCE DATA

DESCRIPTION	VALUE			
	at 1 kHz	at 10 kHz	at 100 kHz	
Tangent of loss angle:				
C ≤ 0.1 μF	≤60 × 10 ⁻⁴	≤120 × 10 ⁻⁴	≤200 × 10 ⁻⁴	
0.1 μF < C ≤ 0.47 μF	≤60 × 10 ⁻⁴	≤120 × 10 ⁻⁴	≤225 × 10 ⁻⁴	
0.47 μF < C ≤ 1.2 μF	≤60 × 10 ⁻⁴	≤120 × 10 ⁻⁴	-	
Rated voltage pulse slope (dU/dt) _R	at 63 V (DC)	at 100 V (DC)	at 250 V (DC)	at 400 V (DC)
	100 V/μs	160 V/μs	400 V/μs	800 V/μs
R between leads, for C ≤ 0.33 μF:				
at 10 V; 1 minute	>15000 MΩ			
at 100 V; 1 minute		>15000 MΩ	>15000 MΩ	>15000 MΩ
RC between leads, for:				
C > 0.33 μF at 10 V; 1 minute	>5000 s			
C > 0.33 μF at 100 V; 1 minute		>5000 s		
R between interconnected leads and case (foil method)	>30000 MΩ	>30000 MΩ	>30000 MΩ	>30000 MΩ
Withstanding (DC) voltage (cut off current 10 mA); rise time 100 V/s	100 V; 1 minute	160 V; 1 minute	400 V; 1 minute	640 V; 1 minute
Withstanding (DC) voltage between leads and case	200 V; 1 minute	200 V; 1 minute	500 V; 1 minute	800 V; 1 minute

$U_{Rdc} = 63 \text{ V}$; $U_{Rac} = 40 \text{ V}$

C (μF)	DIMENSIONS $w \times h \times l$ (mm)	MASS (g)	CATALOG NUMBER 2222 470 ... AND PACKAGING						
			AMMOPACK			REEL	LOOSE IN BOX		
			H = 18.5 mm			SPQ	SPQ	short leads	long leads
			C-tol = $\pm 10\%$	C-tol = $\pm 5\%$	SPQ			SPQ	SPQ
			last 5 digits of catalog number	last 5 digits of catalog number					
Pitch = $5.0 \pm 0.3 \text{ mm}$; $d_t = 0.50 \pm 0.05 \text{ mm}$									
0.068	2.5 × 6.5 × 7.2	0.25	75683	76683	2000	2000	2000	1000	
0.082			75823	76823					
0.1			75104	76104					
0.12	3.5 × 8.0 × 7.2	0.35	75124	76124	1500	1500	2000	1000	
0.15			75154	76154					
0.18			75184	76184					
0.22			75224	76224					
0.27			75274	76274					
0.33			75334	76334					
0.39	75394	76394							
0.47	4.5 × 9.0 × 7.2	0.45	75474	76474	1000	1000	2000	1000	
0.56			75564	76564					
0.68			75684	76684					
0.82	6.0 × 11.0 × 7.2	0.60	75824	76824	750	1000	2000	1000	
1			75105	76105					
1.2			75125	76125					

 $U_{Rdc} = 100 \text{ V}$; $U_{Rac} = 63 \text{ V}$

C (μF)	DIMENSIONS $w \times h \times l$ (mm)	MASS (g)	CATALOG NUMBER 2222 470 ... AND PACKAGING						
			AMMOPACK			REEL	LOOSE IN BOX		
			H = 18.5 mm			SPQ	SPQ	short leads	long leads
			C-tol = $\pm 10\%$	C-tol = $\pm 5\%$	SPQ			SPQ	SPQ
			last 5 digits of catalog number	last 5 digits of catalog number					
Pitch = $5.0 \pm 0.3 \text{ mm}$; $d_t = 0.50 \pm 0.05 \text{ mm}$									
0.022	2.5 × 6.5 × 7.2	0.25	85223	86223	2000	2000	2000	1000	
0.027			85273	86273					
0.033			85333	86333					
0.039			85393	86393					
0.047			85473	86473					
0.056			85563	86563					
0.068	3.5 × 8.0 × 7.2	0.35	85683	86683	1500	1500	2000	1000	
0.082			85823	86823					
0.1			85104	86104					
0.12			85124	86124					
0.15	4.5 × 9.0 × 7.2	0.45	85154	86154	1000	1000	2000	1000	
0.18			85184	86184					
0.22			85224	86224					
0.27	6.0 × 11.0 × 7.2	0.65	85274	86274	750	1000	2000	1000	
0.33			85334	86334					
0.39			85394	86394					
			85474	86474					
0.47									



Metallized Polyester Film Capacitors Vishay BCcomponents
MKT Radial Potted Type

$U_{Rdc} = 250\text{ V}$; $U_{Rac} = 160\text{ V}$

C (μF)	DIMENSIONS $w \times h \times l$ (mm)	MASS (g)	CATALOG NUMBER 2222 470 ... AND PACKAGING						
			AMMOPACK			REEL	LOOSE IN BOX		
			H = 18.5 mm			SPQ	SPQ	short leads	long leads
			C-tol = $\pm 10\%$	C-tol = $\pm 5\%$	SPQ			SPQ	SPQ
			last 5 digits of catalog number	last 5 digits of catalog number					
Pitch = 5.0 \pm 0.3 mm; $d_t = 0.50 \pm 0.05$ mm									
0.01	2.5 \times 6.5 \times 7.2	0.25	35103	36103	2000	2000	2000	1000	
0.012			35123	36123					
0.015			35153	36153					
0.018			35183	36183					
0.022	3.5 \times 8.0 \times 7.2	0.35	35223	36223	1500	1500	2000	1000	
0.027			35273	36273					
0.033			35333	36333					
0.039			35393	36393					
0.047	4.5 \times 9.0 \times 7.2	0.45	35473	36473	1000	1000	2000	1000	
0.056			35563	36563					
0.068			35683	36683					
0.082	6.0 \times 11.0 \times 7.2	0.60	35823	36823	750	1000	2000	1000	
0.1			35104	36104					
0.12			35124	36124					

$U_{Rdc} = 400\text{ V}$; $U_{Rac} = 200\text{ V}$

C (MF)	DIMENSIONS $w \times h \times l$ (mm)	MASS (g)	CATALOG NUMBER 2222 470 ... AND PACKAGING						
			AMMOPACK			REEL	LOOSE IN BOX		
			H = 18.5 mm			SPQ	SPQ	short leads	long leads
			C-tol = $\pm 10\%$	C-tol = $\pm 5\%$	SPQ			SPQ	SPQ
			last 5 digits of catalog number	last 5 digits of catalog number					
Pitch = 5.0 \pm 0.3 mm; $d_t = 0.50 \pm 0.05$ mm									
0.001	2.5 \times 6.5 \times 7.2	0.25	65102	66102	2000	2000	2000	1000	
0.0012			65122	66122					
0.0015			65152	66152					
0.0018			65182	66182					
0.0022			65222	66222					
0.0027			65272	66272					
0.0033			65332	66332					
0.0039			65392	66392					
0.0047			65472	66472					
0.0056			65562	66562					
0.0068			65682	66682					
0.0082			65822	66822					
0.01			3.5 \times 8.0 \times 7.2	0.35					65103
0.012	65123	66123							
0.015	65153	66153							
0.018	4.5 \times 9.0 \times 7.2	0.45	65183	66183	1000	1000	2000	1000	
0.022			65223	66223					
0.027			65273	66273					
0.033	6.0 \times 11.0 \times 7.2	0.60	65333	66333	750	1000	2000	1000	
0.039			65393	66393					
0.047			65473	66473					

MAXIMUM RMS VOLTAGE (SENEAUE) AS A FUNCTION OF FREQUENCY

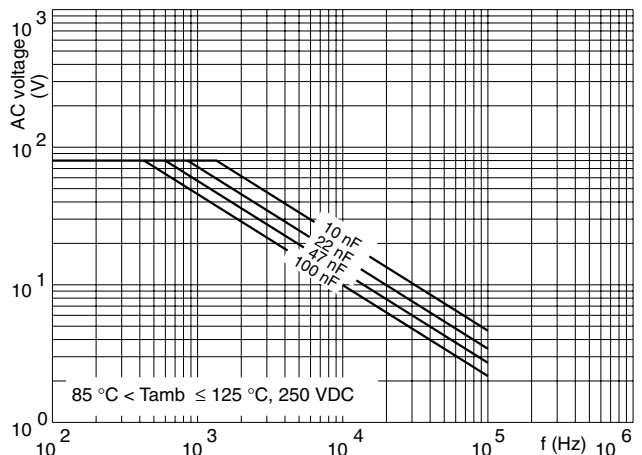
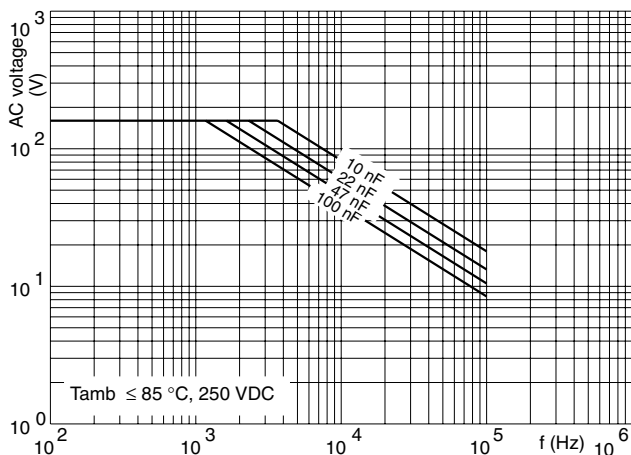
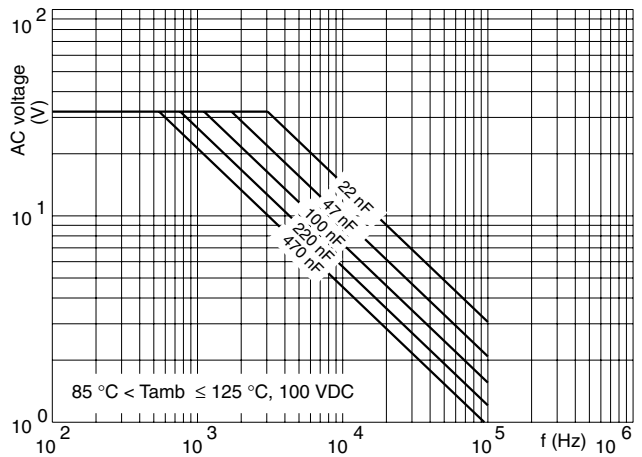
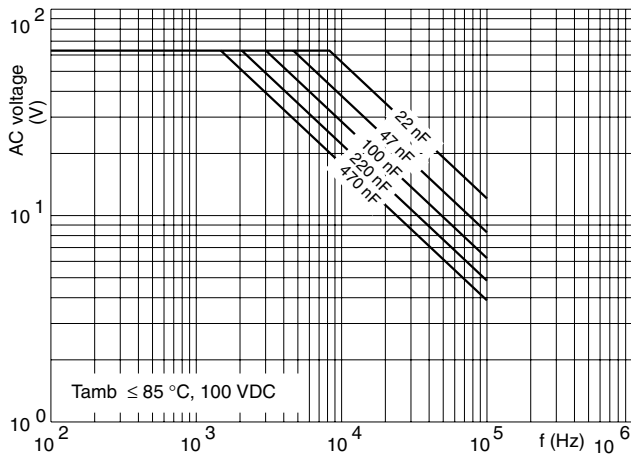
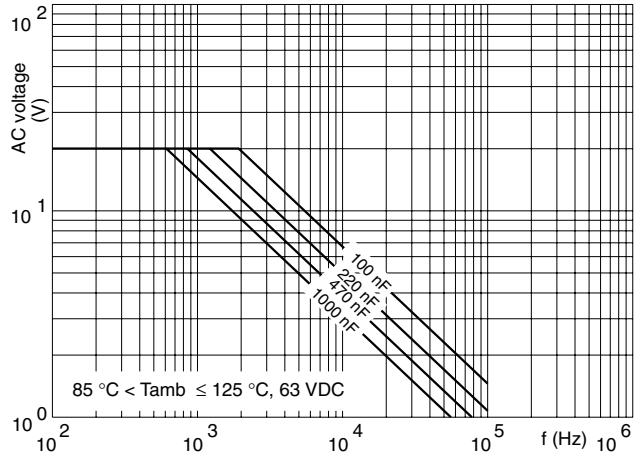
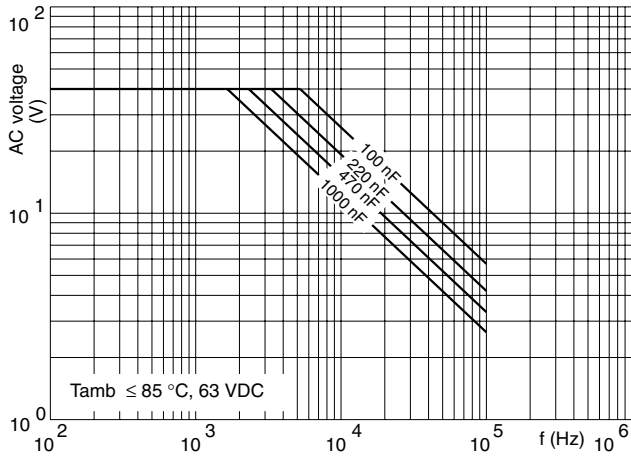



Metallized Polyester Film Capacitors
MKT Radial Potted Type

Vishay BCcomponents

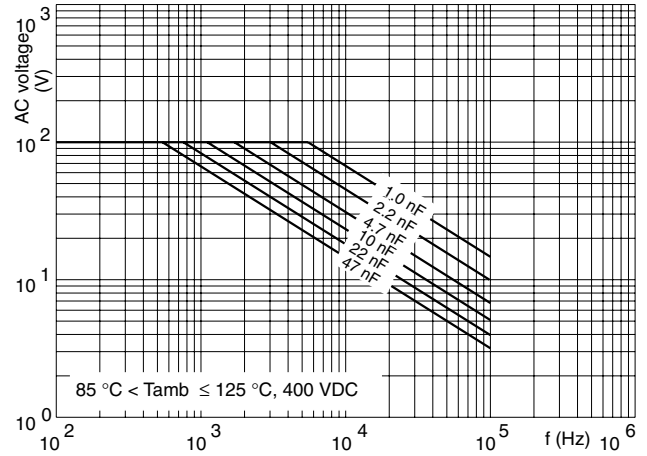
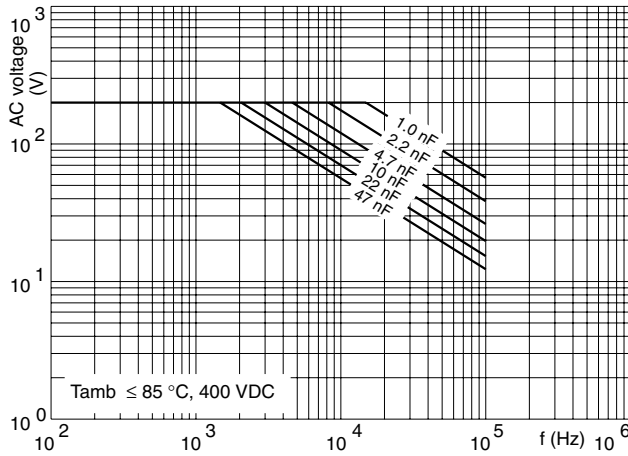

CAPACITANCE

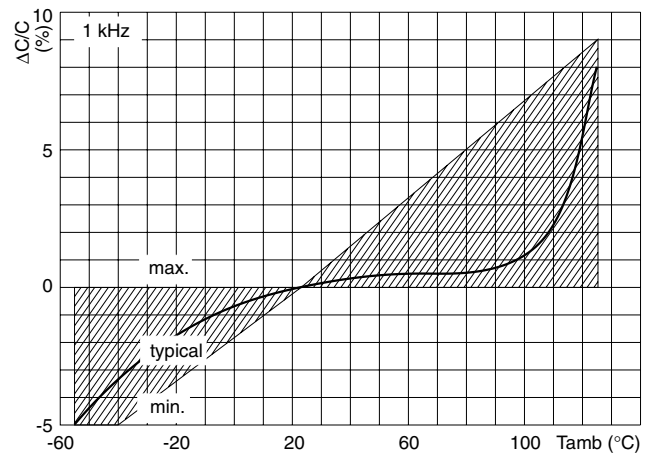
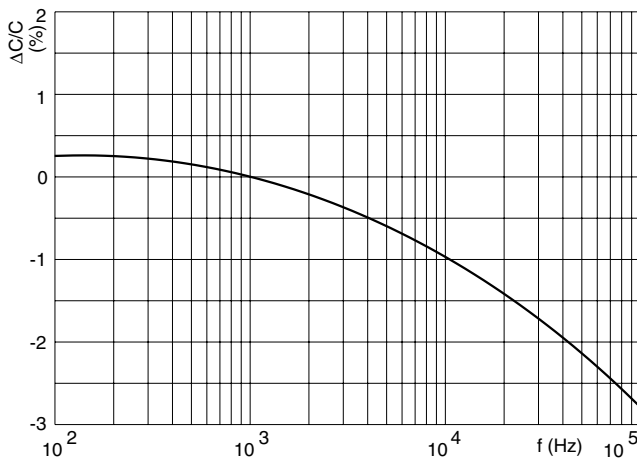

IMPEDANCE

