

# MIW1100 Series

3W, Wide Input Range DIP, Single & Dual Output DC/DC Converters

## Key Features

- Efficiency up to 81%
- 1500VDC Isolation
- MTBF > 1,000,000 Hours
- UL1950 Safety Approval
- Low Cost
- Complies with EN55022 Class A
- Temperature Performance  $-40^{\circ}\text{C}$  to  $+71^{\circ}\text{C}$
- Industry Standard Pinout
- UL 94V-0 Package Material
- Internal SMD Construction



Minmax's MIW1100-Series power modules are low-profile dc-dc converters that operate over input voltage ranges of 4.5–9VDC, 9–18VDC, 18–36VDC and 36–75VDC which provide precisely regulated output voltages of 5V, 12V, 15V,  $\pm 12\text{V}$  and  $\pm 15\text{VDC}$ .

The  $-40^{\circ}\text{C}$  to  $+71^{\circ}\text{C}$  operating temperature range makes it ideal for data communication equipments, mobile battery driven equipments, distributed power systems, telecommunication equipments, mixed analog/digital subsystems, process/machine control equipments, computer peripheral systems and industrial robot systems.

The modules have a maximum power rating of 3W and a typical full-load efficiency of 81%, continuous short circuit, 45mA output ripple, built-in filtering for both input and output minimize the need for external filtering.

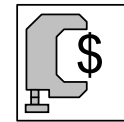

Low Cost

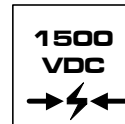

I/O Isolation



EN55022

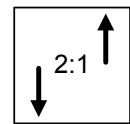

Wide Range

## Block Diagram

### Single Output

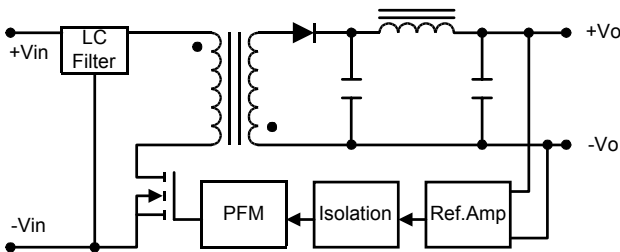

### Dual Output

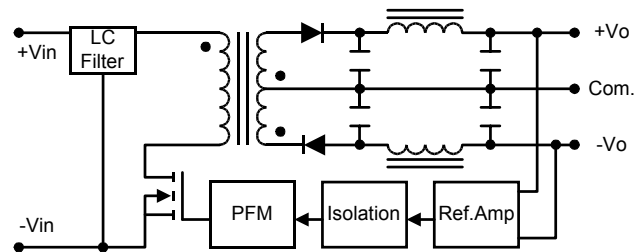

## Model Selection Guide

Model Number	Input Voltage	Output Voltage	Output Current		Input Current		Reflected Ripple Current	Efficiency
			Max.	Min.	@Max. Load	@No Load		@Max. Load
	VDC	VDC	mA	mA	mA (Typ.)	mA (Typ.)	mA (Typ.)	% (Typ.)
MIW1111	5 (4.5 ~ 9)	5	600	60	857	40	100	70
MIW1112		12	250	25	811			74
MIW1113		15	200	20	811			74
MIW1114		±12	±125	±12.5	811			74
MIW1115		±15	±100	±10	811			74
MIW1121	12 (9 ~ 18)	5	600	60	329	20	30	76
MIW1122		12	250	25	313			80
MIW1123		15	200	20	313			80
MIW1124		±12	±125	±12.5	313			80
MIW1125		±15	±100	±10	313			80
MIW1131	24 (18 ~ 36)	5	600	60	162	5	15	77
MIW1132		12	250	25	154			81
MIW1133		15	200	20	154			81
MIW1134		±12	±125	±12.5	154			81
MIW1135		±15	±100	±10	154			81
MIW1141	48 (36 ~ 75)	5	600	60	81	3	10	77
MIW1142		12	250	25	77			81
MIW1143		15	200	20	77			81
MIW1144		±12	±125	±12.5	77			81
MIW1145		±15	±100	±10	77			81

## Absolute Maximum Ratings

Parameter	Min.	Max.	Unit	
Input Surge Voltage (1000 mS)	5VDC Input Models	-0.7	11	VDC
	12VDC Input Models	-0.7	25	VDC
	24VDC Input Models	-0.7	50	VDC
	48VDC Input Models	-0.7	100	VDC
Lead Temperature (1.5mm from case for 10 Sec.)	---	260	°C	
Internal Power Dissipation	---	2,500	mW	

Exceeding the absolute maximum ratings of the unit could cause damage. These are not continuous operating ratings.

## Environmental Specifications

Parameter	Conditions	Min.	Max.	Unit
Operating Temperature	Ambient	-40	+71	°C
Operating Temperature	Case	-40	+90	°C
Storage Temperature		-40	+125	°C
Humidity		---	95	%
Cooling	Free-Air Convection			
Conducted EMI	EN55022 Class A			

## Notes :

- Specifications typical at  $T_a = +25^\circ\text{C}$ , resistive load, nominal input voltage, rated output current unless otherwise noted.
- Transient recovery time is measured to within 1% error band for a step change in output load of 75% to 100%.
- Ripple & Noise measurement bandwidth is 0-20 MHz.
- These power converters require a minimum output loading to maintain specified regulation.
- Operation under no-load conditions will not damage these modules; however, they may not meet all specifications listed.
- All DC/DC converters should be externally fused at the front end for protection.
- Other input and output voltage may be available, please contact factory.
- Specifications subject to change without notice.

# MIW1100 Series

## Input Specifications

Parameter	Model	Min.	Typ.	Max.	Unit
Start Voltage	5V Input Models	3.5	4	4.5	VDC
	12V Input Models	4.5	7	9	
	24V Input Models	8	12	18	
	48V Input Models	16	24	36	
Under Voltage Shutdown	5V Input Models	---	3.5	4	
	12V Input Models	---	6.5	8.5	
	24V Input Models	---	11	17	
	48V Input Models	---	22	34	
Reverse Polarity Input Current	All Models	---	---	1	A
Short Circuit Input Power		---	1000	1500	mW
Input Filter		Pi Filter			

## Output Specifications

Parameter	Conditions	Min.	Typ.	Max.	Unit
Output Voltage Accuracy		---	$\pm 0.5$	$\pm 2.0$	%
Output Voltage Balance	Dual Output, Balanced Loads	---	$\pm 0.5$	$\pm 2.0$	%
Line Regulation	$V_{in} = \text{Min. to Max.}$	---	$\pm 0.2$	$\pm 0.5$	%
Load Regulation	$I_o = 10\% \text{ to } 100\%$	---	$\pm 0.2$	$\pm 0.5$	%
Ripple & Noise (20MHz)		---	45	60	mV P-P
Ripple & Noise (20MHz)	Over Line, Load & Temp.	---	---	100	mV P-P
Ripple & Noise (20MHz)		---	---	15	mV rms
Over Power Protection		120	---	---	%
Transient Recovery Time	25% Load Step Change	---	300	500	$\mu\text{s}$
Transient Response Deviation		---	$\pm 3$	$\pm 5$	%
Temperature Coefficient		---	$\pm 0.01$	$\pm 0.02$	%/°C
Output Short Circuit	Continuous				

## General Specifications

Parameter	Conditions	Min.	Typ.	Max.	Unit
Isolation Voltage Rated	60 Seconds	1500	---	---	VDC
Isolation Voltage Test	Flash Tested for 1 Second	1650	---	---	VDC
Isolation Resistance	500VDC	1000	---	---	M $\Omega$
Isolation Capacitance	100KHz, 1V	---	---	150	pF
Switching Frequency		---	300	---	KHz
MTBF	MIL-HDBK-217F @ 25°C, Ground Benign	1000	---	---	K Hours

## Capacitive Load

Models by Vout	5V	12V	15V	$\pm 12V$ #	$\pm 15V$ #	Unit
Maximum Capacitive Load	2000	2000	2000	1000	1000	$\mu\text{F}$

# For each output

## Input Fuse Selection Guide

5V Input Models	12V Input Models	24V Input Models	48V Input Models
1500mA Slow – Blow Type	700mA Slow – Blow Type	350mA Slow – Blow Type	135mA Slow – Blow Type

## Input Voltage Transient Rating

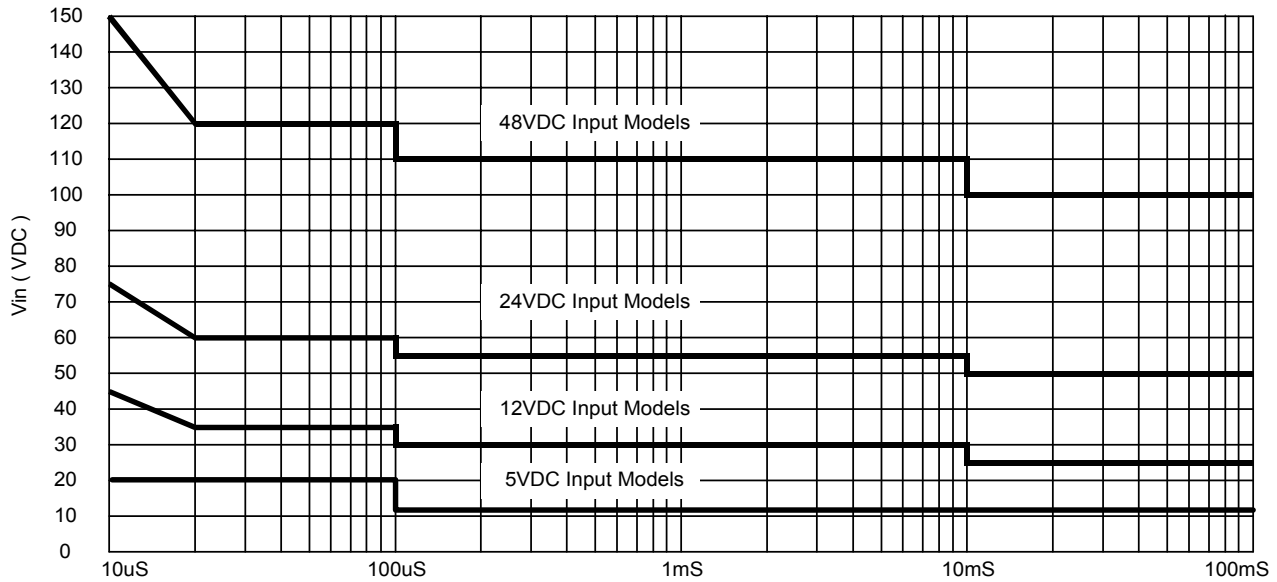

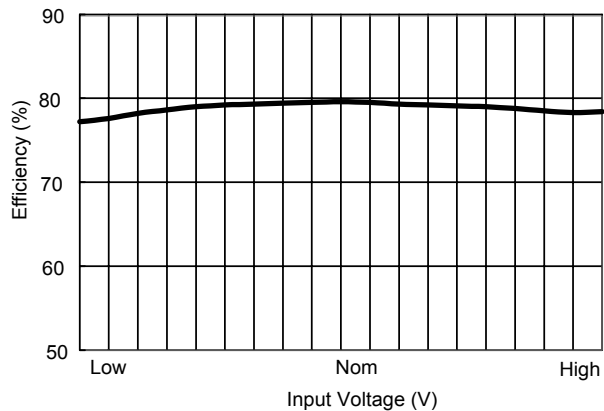

**Efficiency vs Input Voltage ( Single Output )**

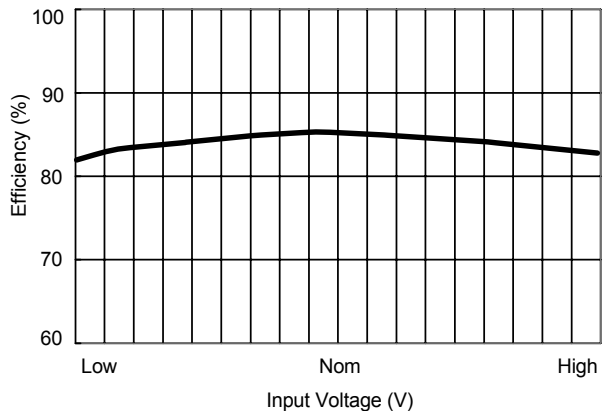

**Efficiency vs Input Voltage ( Dual Output )**

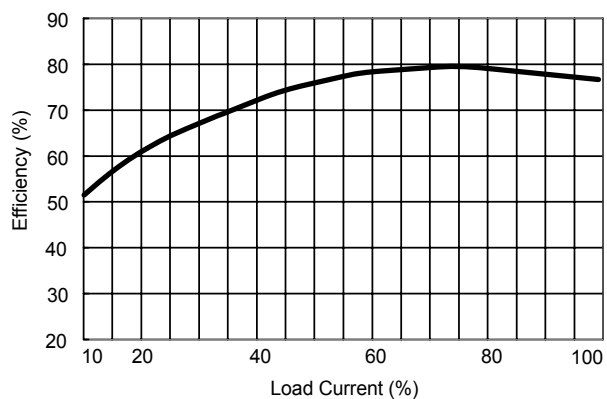

**Efficiency vs Output Load ( Single Output )**

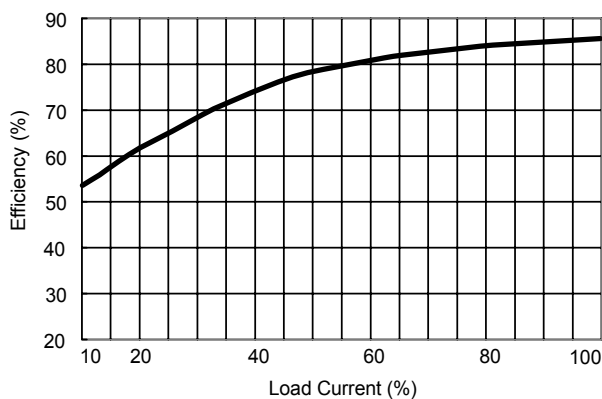

**Efficiency vs Output Load ( Dual Output )**

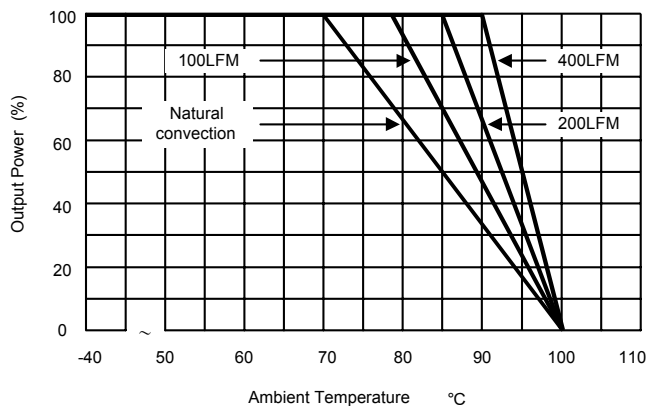

**Derating Curve**

## Test Configurations

### Input Reflected-Ripple Current Test Setup

Input reflected-ripple current is measured with an inductor  $L_{in}$  (4.7uH) and  $C_{in}$  (220uF, ESR < 1.0Ω at 100 KHz) to simulate source impedance.

Capacitor  $C_{in}$ , offsets possible battery impedance.

Current ripple is measured at the input terminals of the module, measurement bandwidth is 0–500 KHz.

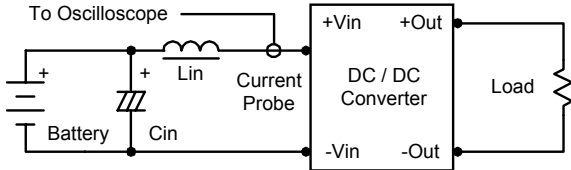

### Peak-to-Peak Output Noise Measurement Test

Use a  $C_{out}$  0.47uF ceramic capacitor.

Scope measurement should be made by using a BNC socket, measurement bandwidth is 0–20 MHz. Position the load between 50 mm and 75 mm from the DC/DC Converter.

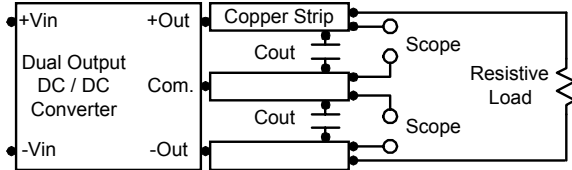
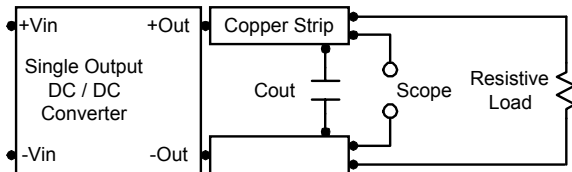

## Design & Feature Considerations

### Maximum Capacitive Load

The MIW1100 series has limitation of maximum connected capacitance at the output.

The power module may be operated in current limiting mode during start-up, affecting the ramp-up and the startup time.

For optimum performance we recommend 1000uF maximum capacitive load for dual outputs and 2000uF capacitive load for single outputs.

The maximum capacitance can be found in the data sheet.

### Overcurrent Protection

To provide protection in a fault (output overload) condition, the unit is equipped with internal current limiting circuitry and can endure current limiting for an unlimited duration. At the point of current-limit inception, the unit shifts from voltage control to current control. The unit operates normally once the output current is brought back into its specified range.

### Input Source Impedance

The power module should be connected to a low ac-impedance input source. Highly inductive source impedances can affect the stability of the power module.

In applications where power is supplied over long lines and output loading is high, it may be necessary to use a capacitor at the input to ensure startup.

Capacitor mounted close to the power module helps ensure stability of the unit, it is recommended to use a good quality low Equivalent Series Resistance (ESR < 1.0Ω at 100 KHz) capacitor of a 8.2uF for the 5V input devices, a 3.3uF for the 12V input devices and a 1.5uF for the 24V and 48V devices.

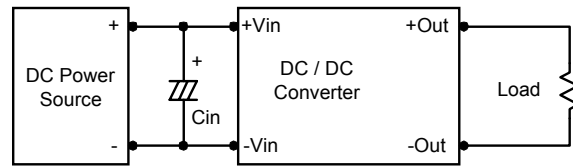

### Output Ripple Reduction

A good quality low ESR capacitor placed as close as practicable across the load will give the best ripple and noise performance.

To reduce output ripple, it is recommended to use 3.3uF capacitors at the output.

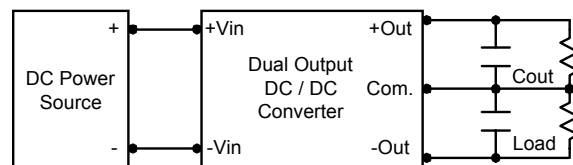
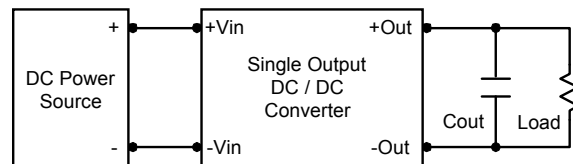

# MIW1 100 Series

---

## Thermal Considerations

Many conditions affect the thermal performance of the power module, such as orientation, airflow over the module and board spacing. To avoid exceeding the maximum temperature rating of the components inside the power module, the case temperature must be kept below 90°C.

The derating curves are determined from measurements obtained in an experimental apparatus.

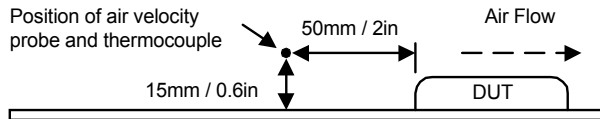

## Mechanical Dimensions

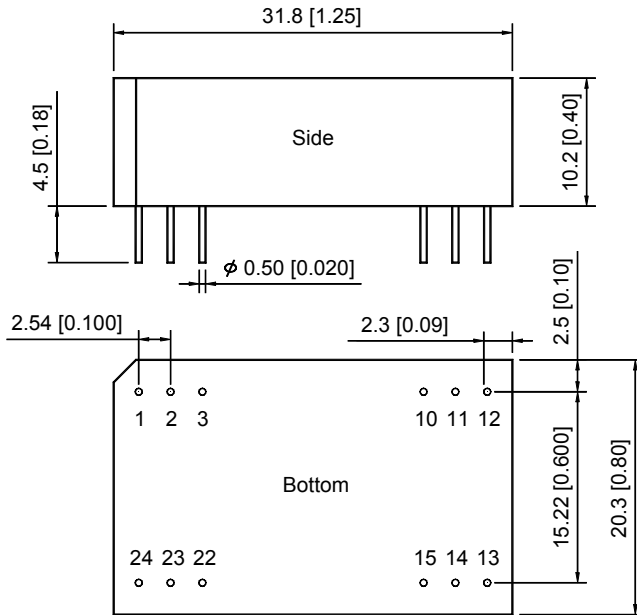

Tolerance	Millimeters	Inches
	X.X±0.25	X.XX±0.01
	X.XX±0.13	X.XXX±0.005
Pin	±0.05	±0.002

## Connecting Pin Patterns

Top View ( 2.54 mm / 0.1 inch grids )

### Single Output

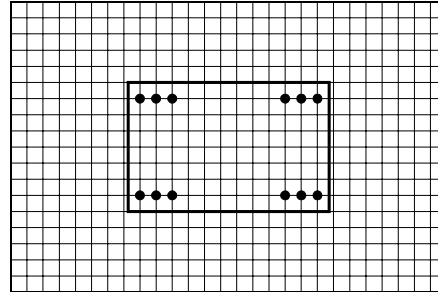

### Dual Output

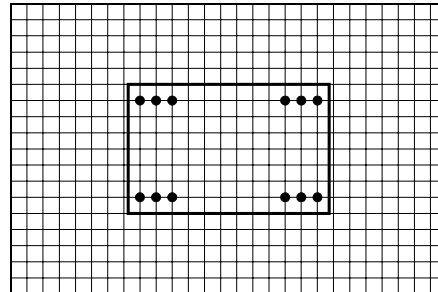

## Pin Connections

Pin	Single Output	Dual Output
1	+Vin	+Vin
2	NC	-Vout
3	NC	Common
10	-Vout	Common
11	+Vout	+Vout
12	-Vin	-Vin
13	-Vin	-Vin
14	+Vout	+Vout
15	-Vout	Common
22	NC	Common
23	NC	-Vout
24	+Vin	+Vin

NC: No Connection

## Physical Characteristics

<b>Case Size</b>	: 31.8×20.3×10.2 mm 1.25×0.80×0.40 inches
<b>Case Material</b>	: Non-Conductive Black Plastic
<b>Weight</b>	: 12.4g
<b>Flammability</b>	: UL94V-0

The MIW1100 converter is encapsulated in a low thermal resistance molding compound that has excellent resistance/electrical characteristics over a wide temperature range or in high humidity environments.

The encapsulant and unit case are both rated to UL 94V-0 flammability specifications.

Leads are tin plated for improved solderability.