

L & S BAND GaAs FET [SMD non – matched]**DESCRIPTION**

The MGF0921A GaAs FET with an N-channel schottky Gate, is designed for use UHF band amplifiers.

FEATURES

- High output power
Po=33dBm(TYP.) @f=1.9GHz,Pin=17dBm
- High power gain
Gp=17dB(TYP.) @f=1.9GHz
- High power added efficiency
 η_{add} =40%(TYP.) @f=1.9GHz,Pin=17dBm
- Hermetic Package

APPLICATION

- For UHF Band power amplifiers

QUALITY

- GG

RECOMMENDED BIAS CONDITIONS

- Vds=10V • Ids=500mA • Rg=200 Ω

Delivery -01:Tape & Reel(1K), -03:Trai(50pcs)

Absolute maximum ratings (Ta=25°C)

Symbol	Parameter	Ratings	Unit
VGSO	Gate to sourcebreakdown voltage	-15	V
VGDO	Gate to drain breakdown voltage	-15	V
ID	Drain current	1800	mA
IGR	Reverse gate current	-5.0	mA
IGF	Forward gate current	15	mA
PT	Total power dissipation	10	W
Tch	Channel temperature	175	°C
Tstg	Storage temperature	-65 to +175	°C

Fig.1**Electrical characteristics** (Ta=25°C)

Symbol	Parameter	Test conditions	Limits			Unit
			Min.	Typ.	Max.	
IDSS	Saturated drain current	VDS=3V,VGS=0V	--	1100	1800	mA
VGS(off)	Gate to source cut-off voltage	VDS=3V,ID=4.0mA	-1.0	-	-5.0	V
gm	Transconductance	VDS=3V,ID=500mA	-	370	-	mS
Po	Output power	VDS=10V,ID=500mA,f=1.9GHz	31	33	-	dBm
η_{add}	Power added Efficiency	Pin=17dBm	-	38	-	%
GLP	Linear Power Gain	VDS=10V,ID=500mA,f=1.9GHz	15	17	-	dB
Rth(ch-c)	Thermal Resistance *1	Δ Vf Method	-	11	15	°C/W

*1:Channel to case / Above parameters, ratings, limits are subject to change.

MGF0921A TYPICAL CHARACTERISTICS

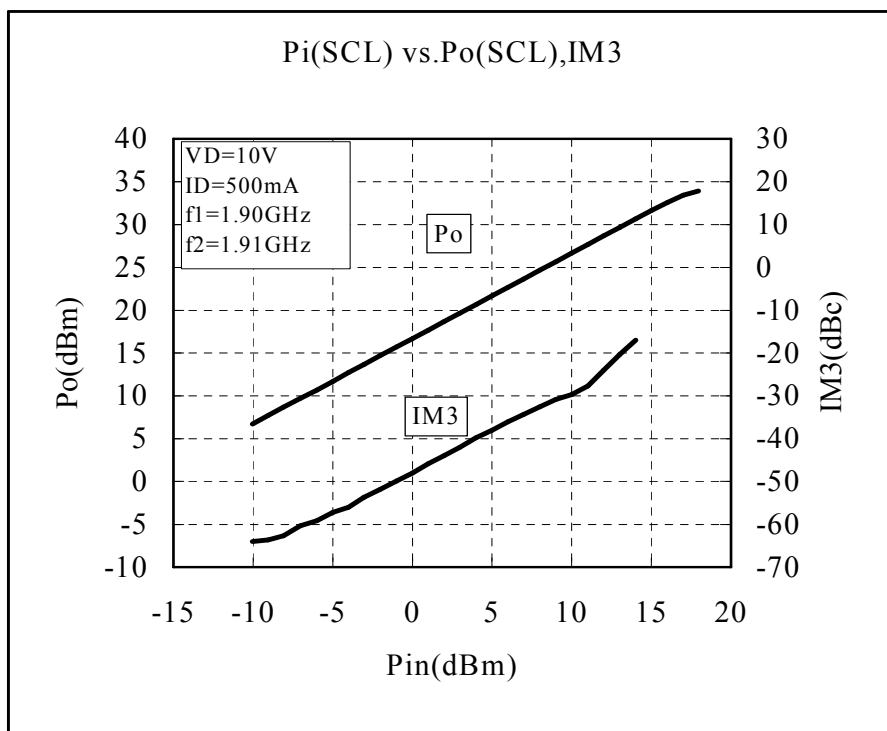
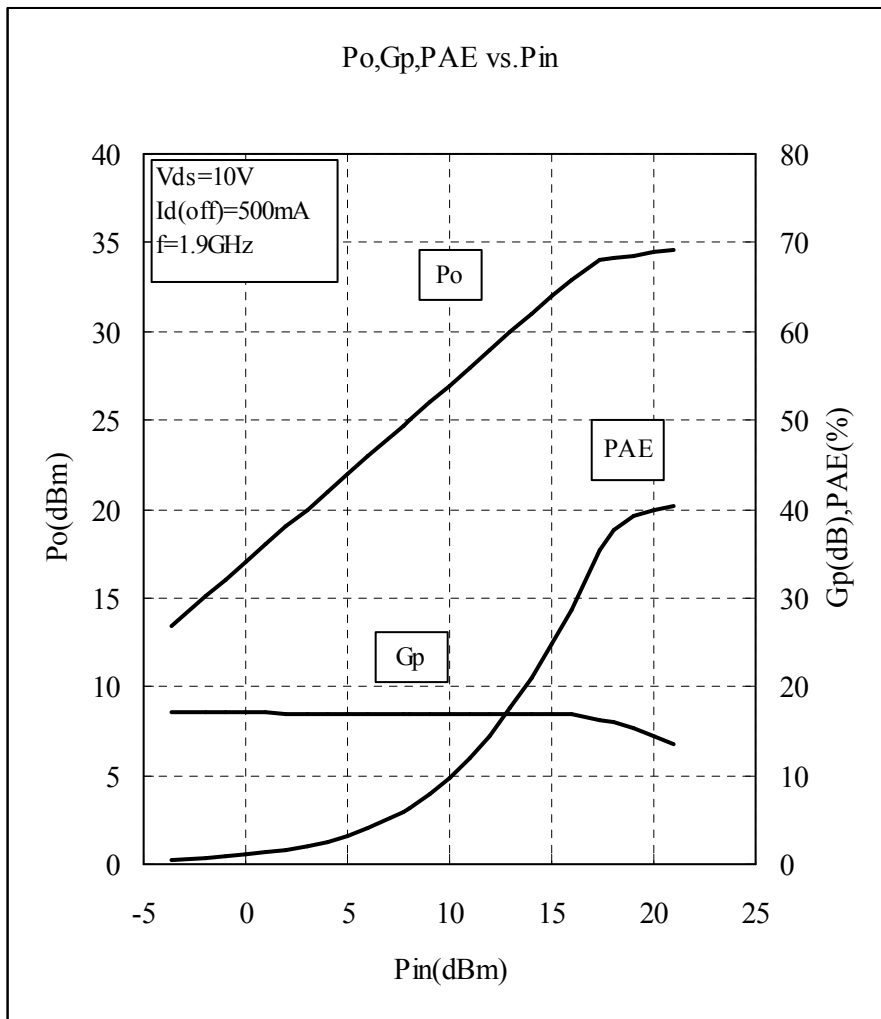

MGF0921A S PARAMETERS (Ta=25°C,VD=10V,ID=500mA, Reference Plane see Fig.1)

freq. (MHz)	S11		S21		S12		S22		K	MAG/MSG (dB)
	(mag)	(ang)	(mag)	(ang)	(mag)	(ang)	(mag)	(ang)		
600	0.928	-120.29	6.597	111.05	0.018	31.80	0.605	-172.68	0.29	25.64
1000	0.922	-144.64	4.629	94.88	0.022	22.95	0.619	-173.49	0.37	23.23
1400	0.919	-156.53	3.312	82.95	0.023	17.64	0.633	-173.69	0.46	21.58
1800	0.918	-162.98	2.465	73.91	0.023	14.81	0.646	-173.51	0.59	20.30
2200	0.918	-167.59	1.943	66.76	0.022	13.62	0.657	-173.14	0.78	19.46
2600	0.918	-171.55	1.638	60.71	0.021	13.45	0.666	-172.72	0.97	18.92
3000	0.918	-174.74	1.467	55.23	0.020	13.81	0.673	-172.38	1.14	16.41
3400	0.917	-176.80	1.369	49.96	0.021	14.36	0.679	-172.19	1.13	15.92
3800	0.915	-178.13	1.306	44.67	0.022	14.88	0.684	-172.23	1.12	15.64
4200	0.912	179.10	1.252	39.24	0.023	15.23	0.689	-172.51	1.13	15.19
4600	0.907	178.57	1.195	33.65	0.025	15.31	0.692	-173.04	1.11	14.81
5000	0.901	176.73	1.130	27.89	0.028	15.10	0.695	-173.79	1.07	14.40
5400	0.893	173.69	1.060	22.01	0.030	14.57	0.698	-174.72	1.16	13.09
5800	0.884	169.77	0.990	16.05	0.033	13.75	0.699	-175.77	1.23	11.91
6200	0.875	165.38	0.927	10.04	0.036	12.62	0.699	-176.86	1.31	10.79
6600	0.865	160.90	0.879	4.00	0.040	11.18	0.697	-177.90	1.35	9.89
7000	0.854	156.64	0.851	-2.11	0.044	9.40	0.691	-178.80	1.39	9.13
7400	0.843	152.74	0.848	-8.33	0.048	7.23	0.683	-179.47	1.40	8.72
7800	0.831	149.18	0.871	-14.76	0.054	4.59	0.670	-179.82	1.31	8.71
8200	0.817	145.73	0.917	-21.54	0.061	1.36	0.652	179.47	1.22	8.93
8600	0.800	142.03	0.981	-28.84	0.070	-2.57	0.630	178.51	1.12	9.39
9000	0.778	137.54	1.056	-36.86	0.082	-7.38	0.602	177.26	1.03	10.07
9400	0.750	131.70	1.132	-45.79	0.095	-13.23	0.571	175.75	1.00	10.76
9800	0.711	123.95	1.201	-55.85	0.112	-20.32	0.536	173.84	1.01	9.78
10200	0.671	113.89	1.253	-67.22	0.132	-28.83	0.502	171.52	1.01	9.09
10600	0.636	101.36	1.285	-80.02	0.154	-38.94	0.470	169.20	1.01	8.57
11000	0.623	86.68	1.295	-94.34	0.179	-50.78	0.447	167.97	0.96	8.59
11400	0.643	70.74	1.293	-110.12	0.205	-64.45	0.369	169.96	0.95	8.00
11800	0.699	55.29	1.297	-127.21	0.231	-79.99	0.293	178.54	0.90	7.49
12200	0.778	43.12	1.342	-145.25	0.256	-97.34	0.281	-154.64	0.84	7.20

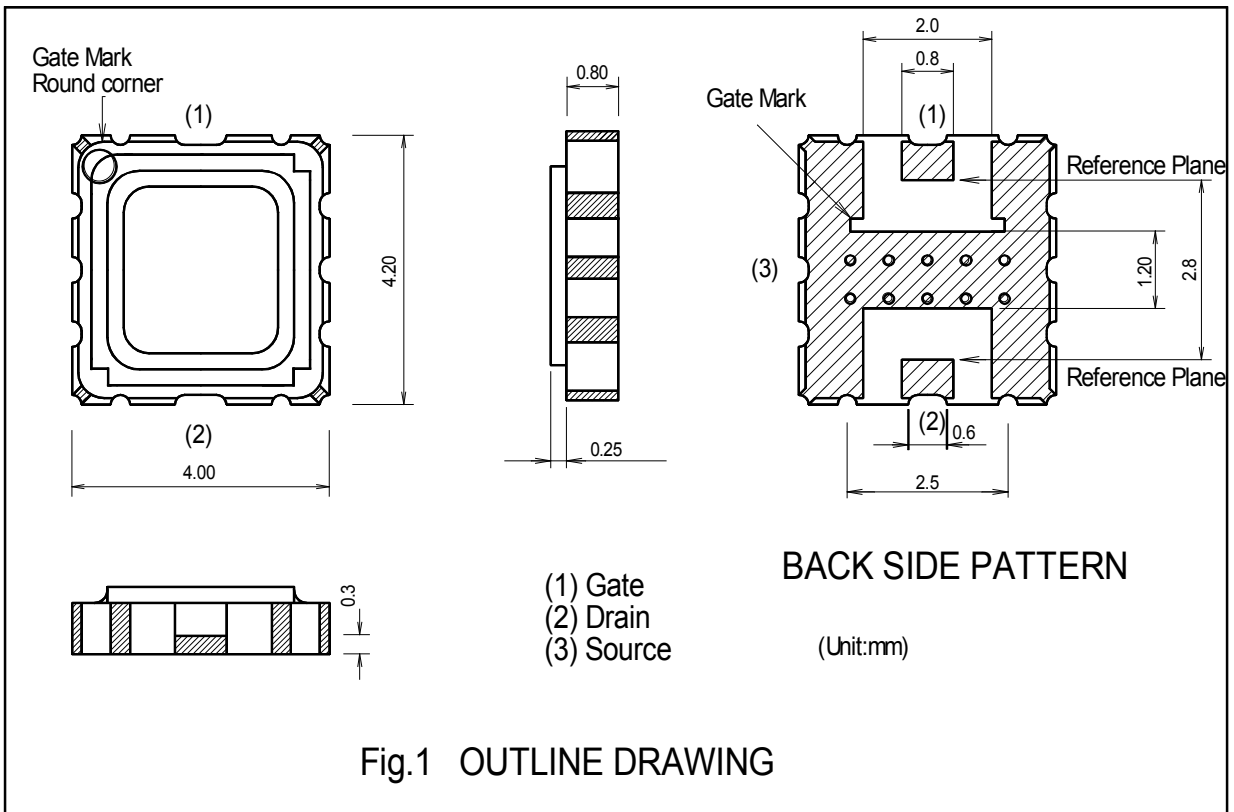
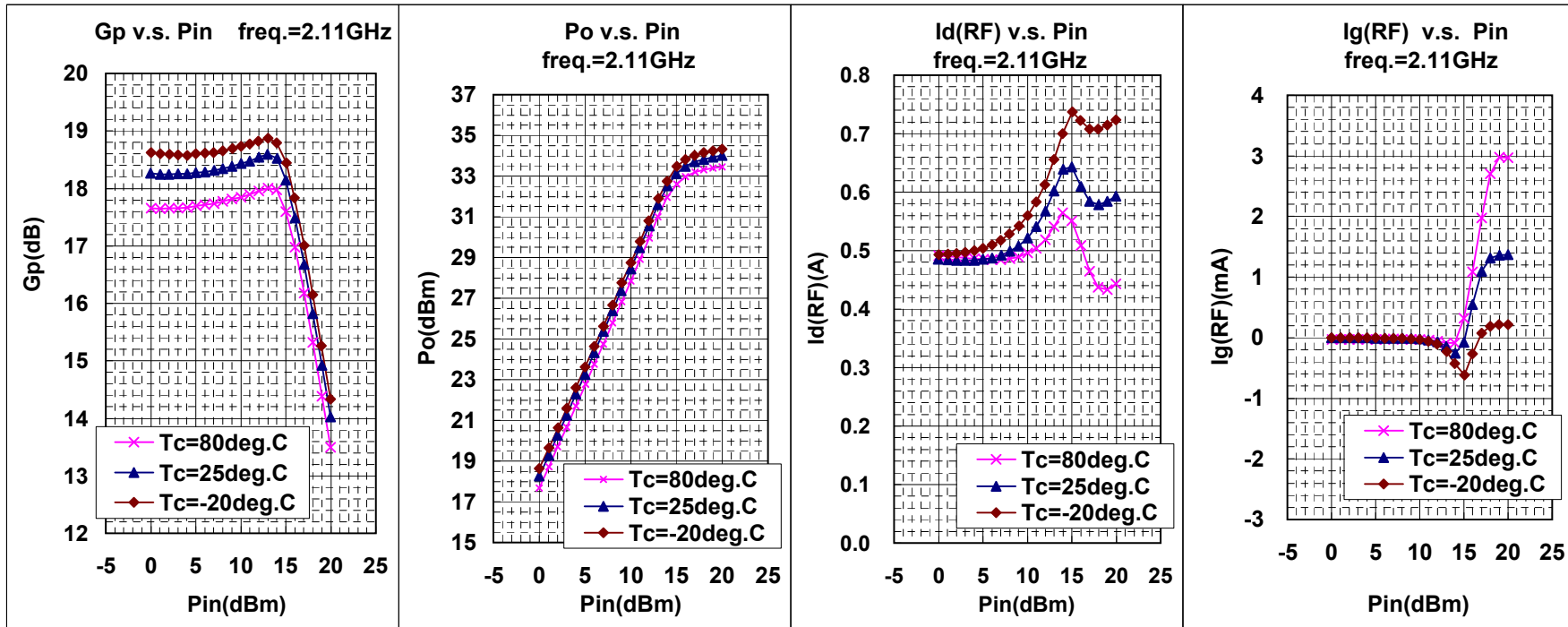
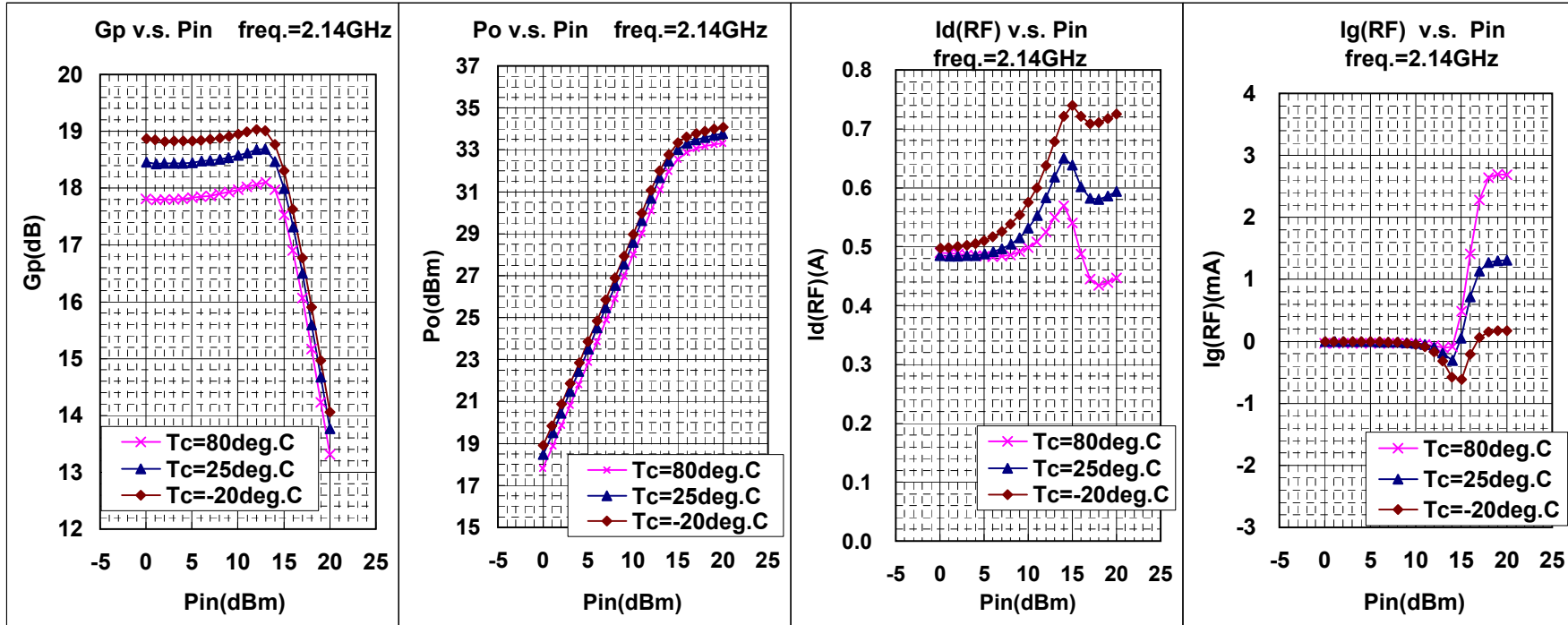

Fig.1 OUTLINE DRAWING

MGF0921A RF TEST DATA(CW) VD=10V, IDQ=0.5A
 Gp, Po, Id(RF), Ig(RF) v.s. Pin



MGF0921A RF TEST DATA(CW) VD=10V, IDQ=0.5A
Gp, Po, Id(RF), Ig(RF) v.s. Pin



MGF0921A RF TEST DATA(CW) VD=10V, IDQ=0.5A
Gp, Po, Id(RF), Ig(RF) v.s. Pin

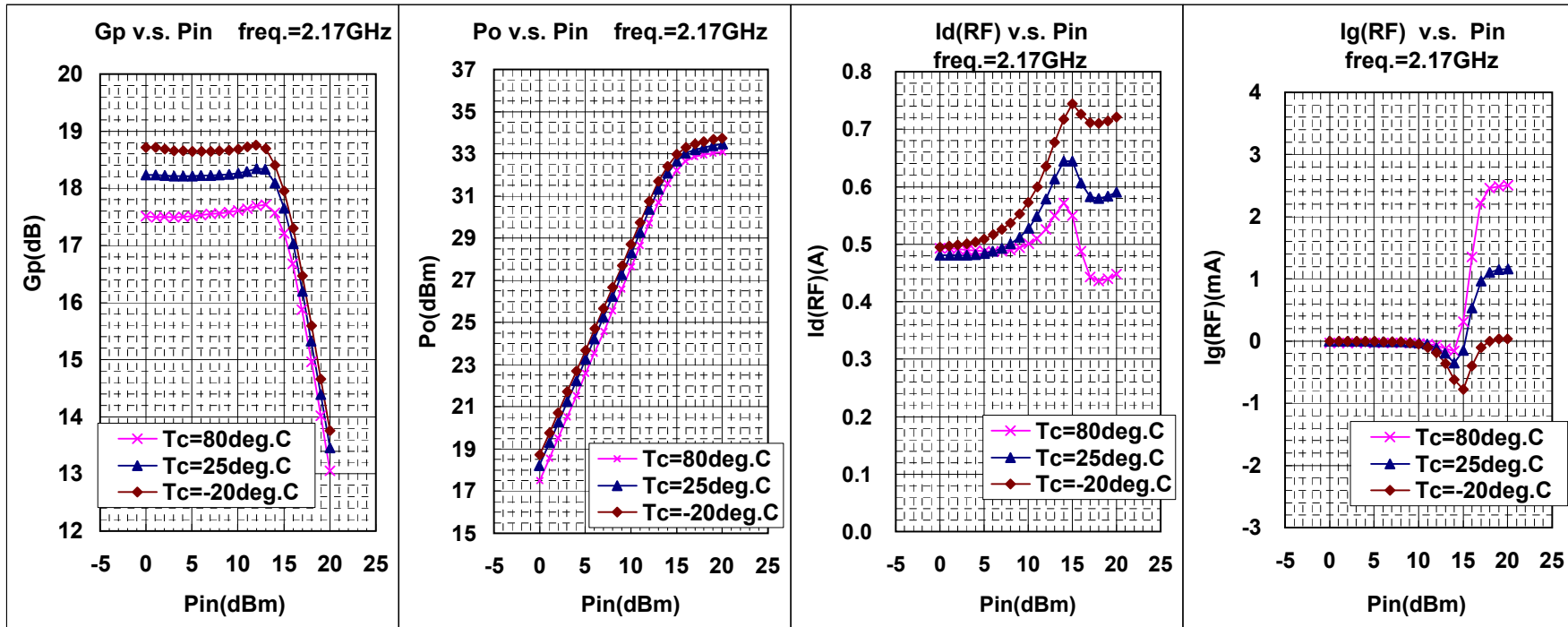

MGF0921A RF TEST DATA(CW)

Gp,Po,Id(RF),Ig(RF) v.s. Pin

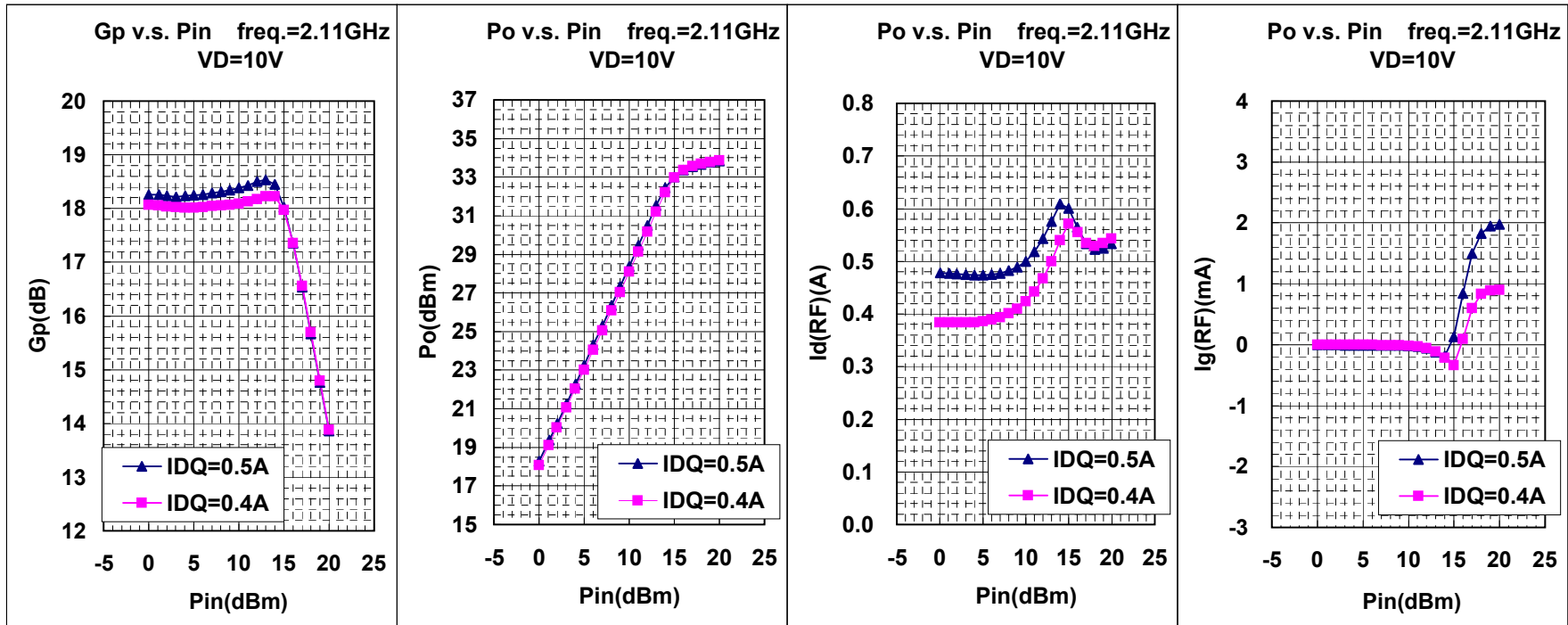

MGF0921A RF TEST DATA(CW)
Gp,Po,Id(RF),Ig(RF) v.s. Pin

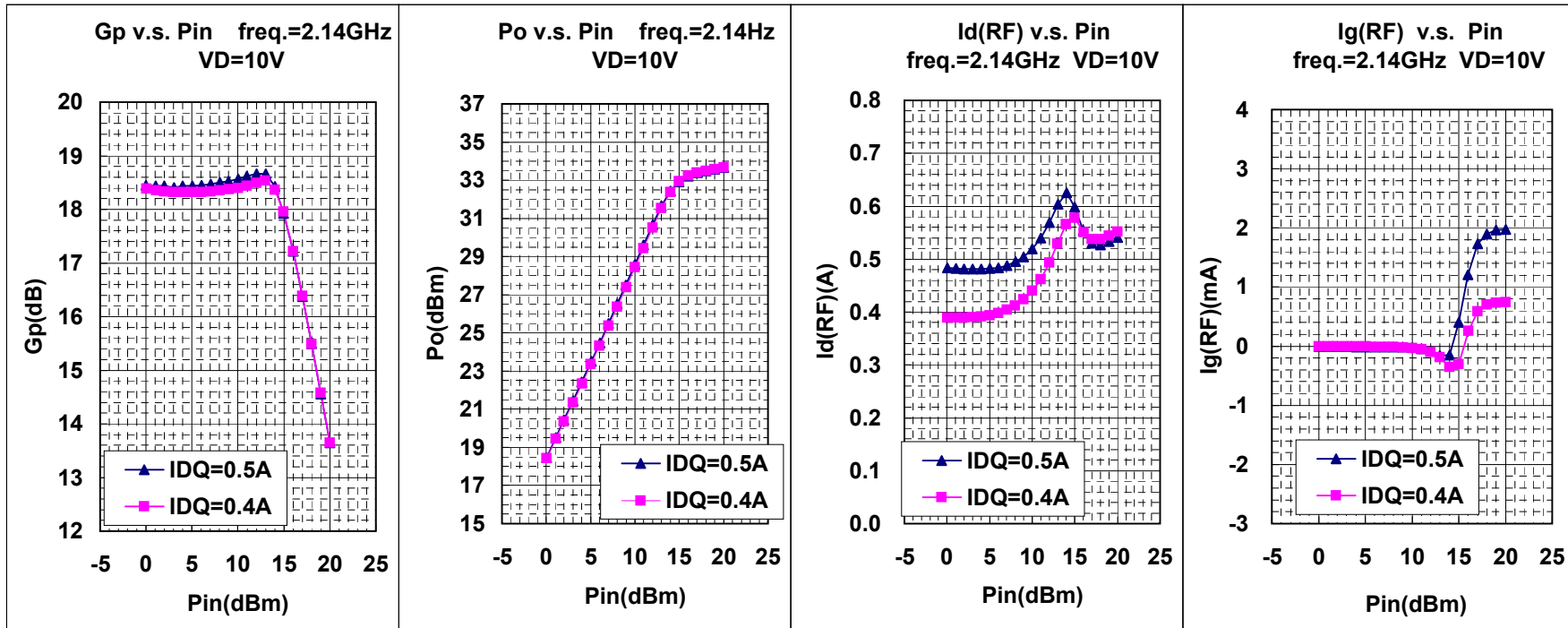

MGF0921A RF TEST DATA(CW)
Gp,Po,Id(RF),Ig(RF) v.s. Pin

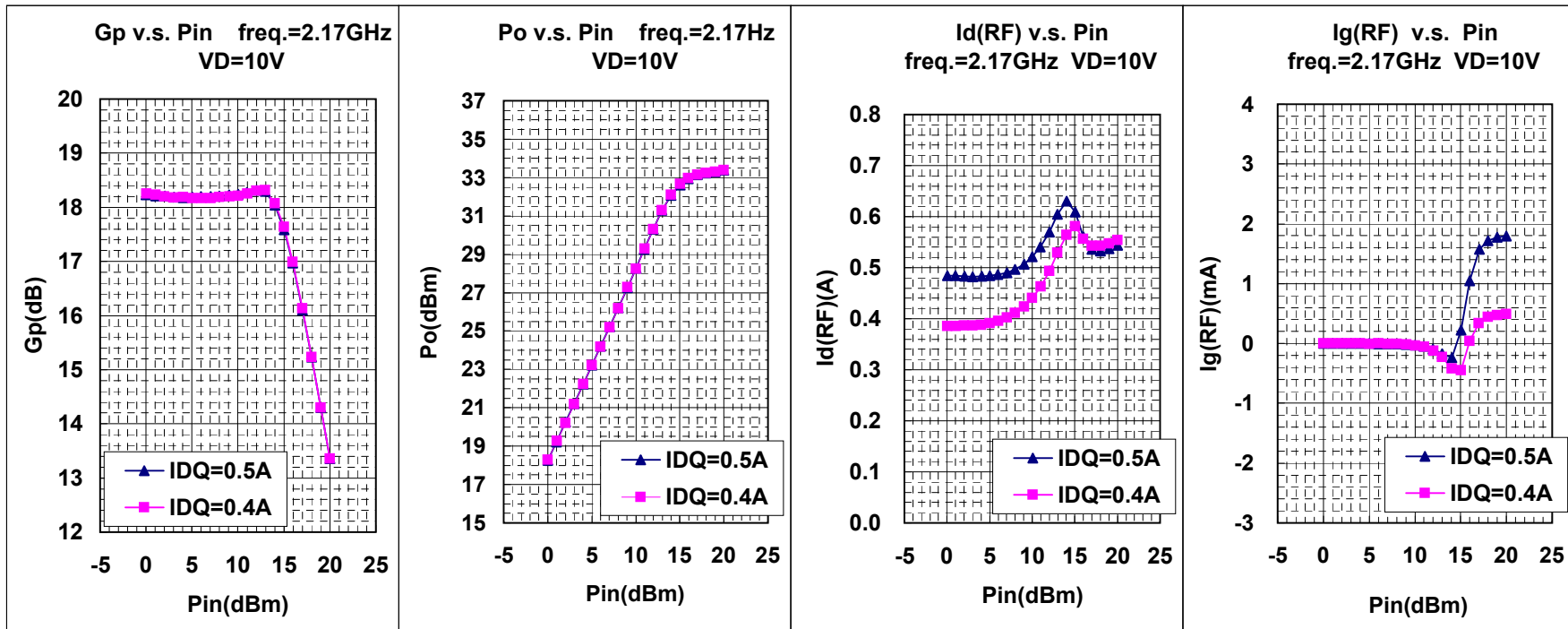

MGF0921A RF TEST DATA(CW)

Gp,Po,Id(RF),I_g(RF) v.s. Pin

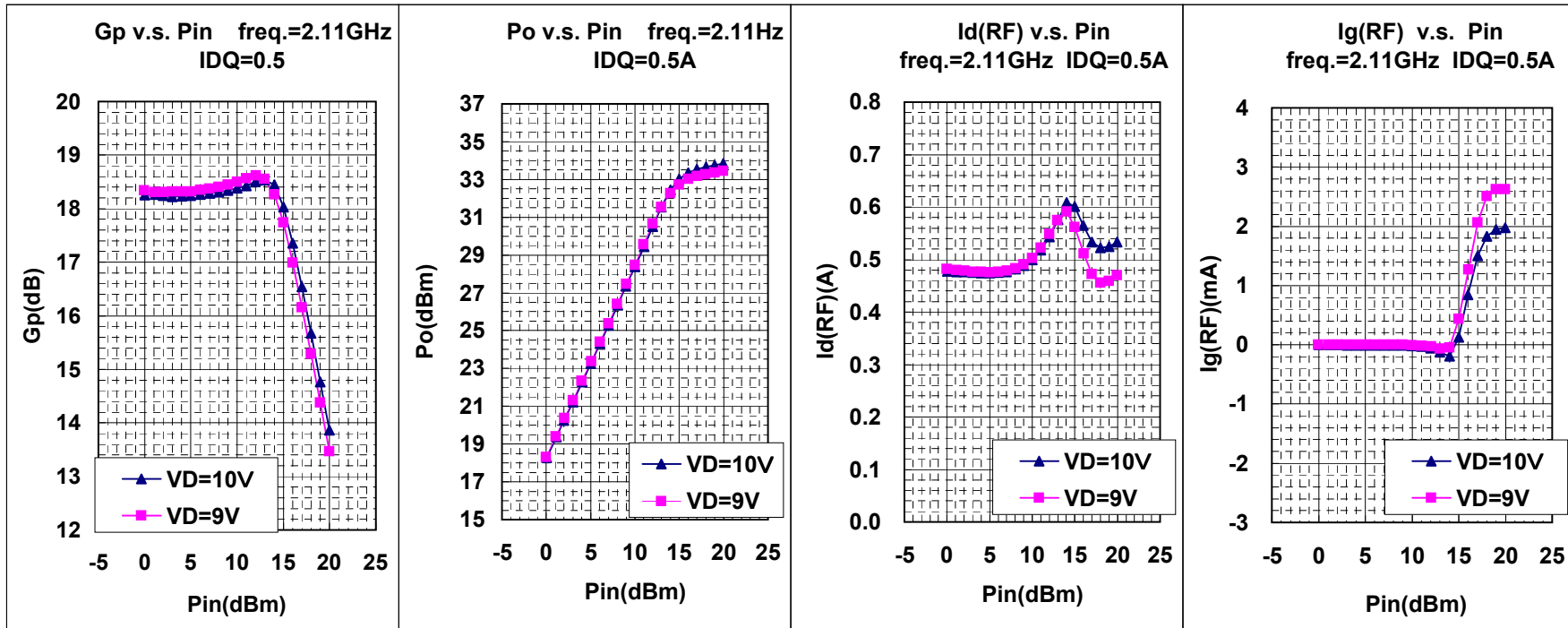

MGF0921A RF TEST DATA(CW)
Gp,Po,Id(RF),Ig(RF) v.s. Pin

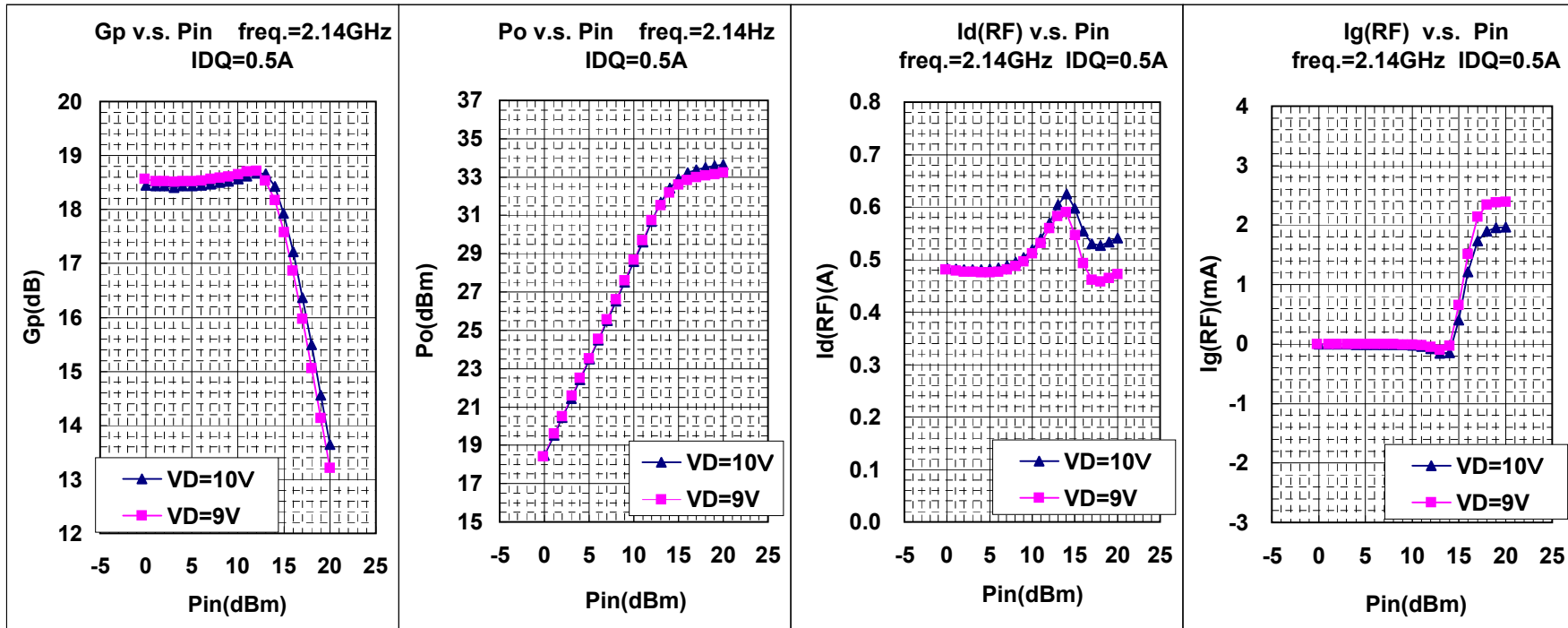

MGF0921A RF TEST DATA(CW)
Gp,Po,Id(RF),Ig(RF) v.s. Pin

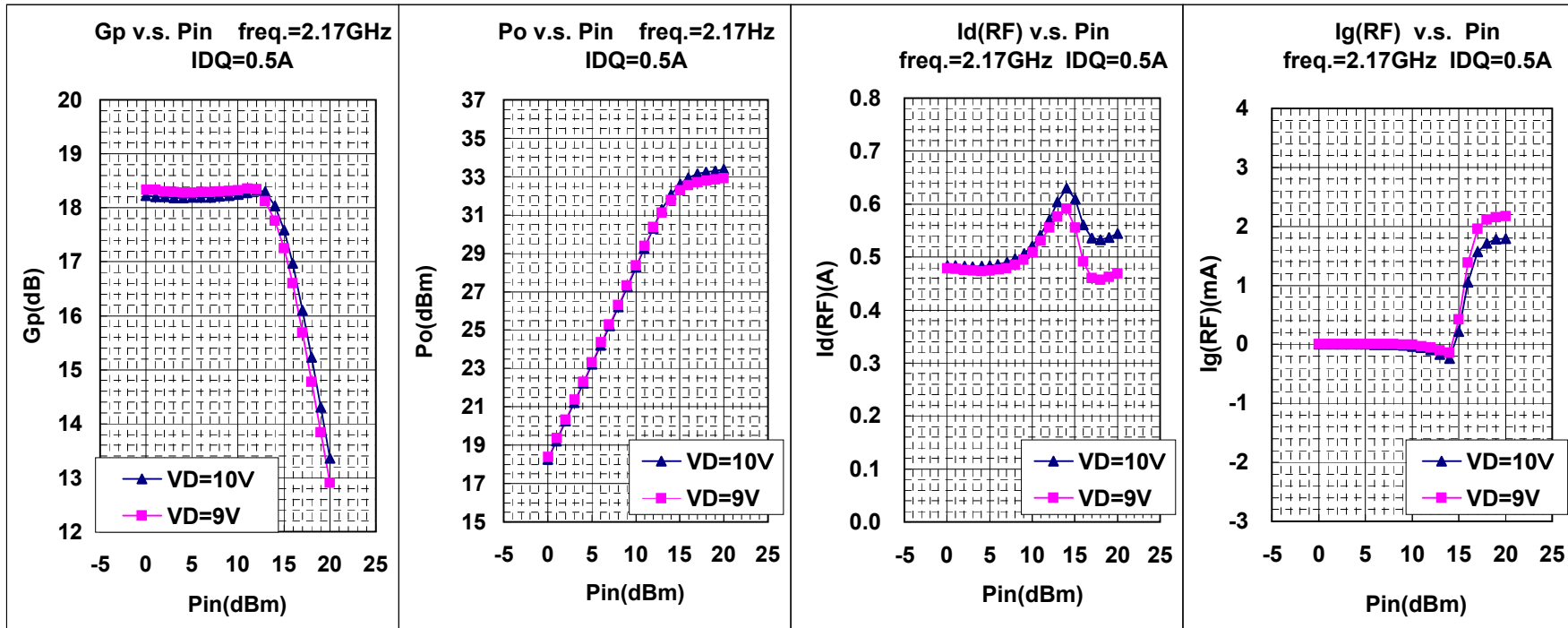

MGF0921A RF TEST DATA(W-CDMA) VD=10V,IDQ=0.5A
ACLR v.s. Po 3GPP TEST MODEL1 64ch's 2carrier Signal

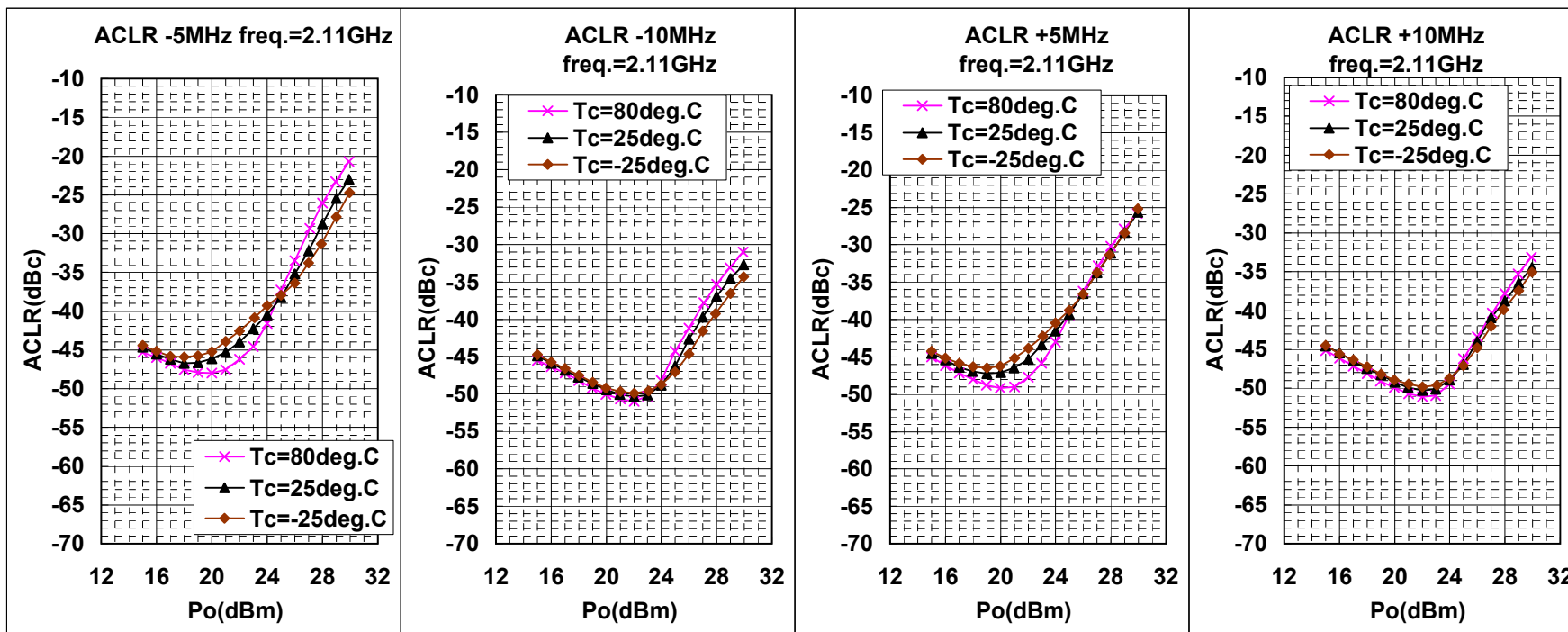

MGF0921A RF TEST DATA(W-CDMA) VD=10V,IDQ=0.5A
ACLR v.s. Po 3GPP TEST MODEL1 64ch's 2carrier Signal

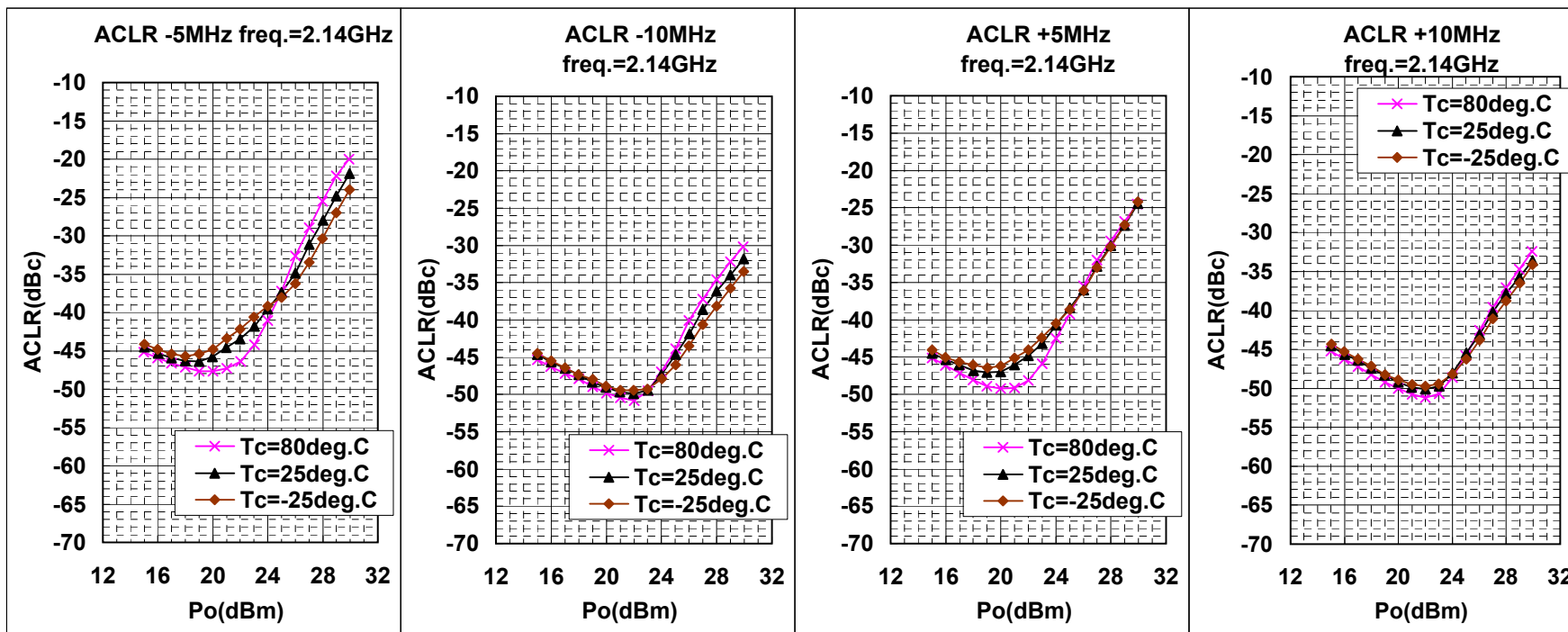

MGF0921A RF TEST DATA(W-CDMA) VD=10V,IDQ=0.5A
ACLR v.s. Po 3GPP TEST MODEL1 64ch's 2carrier Signal

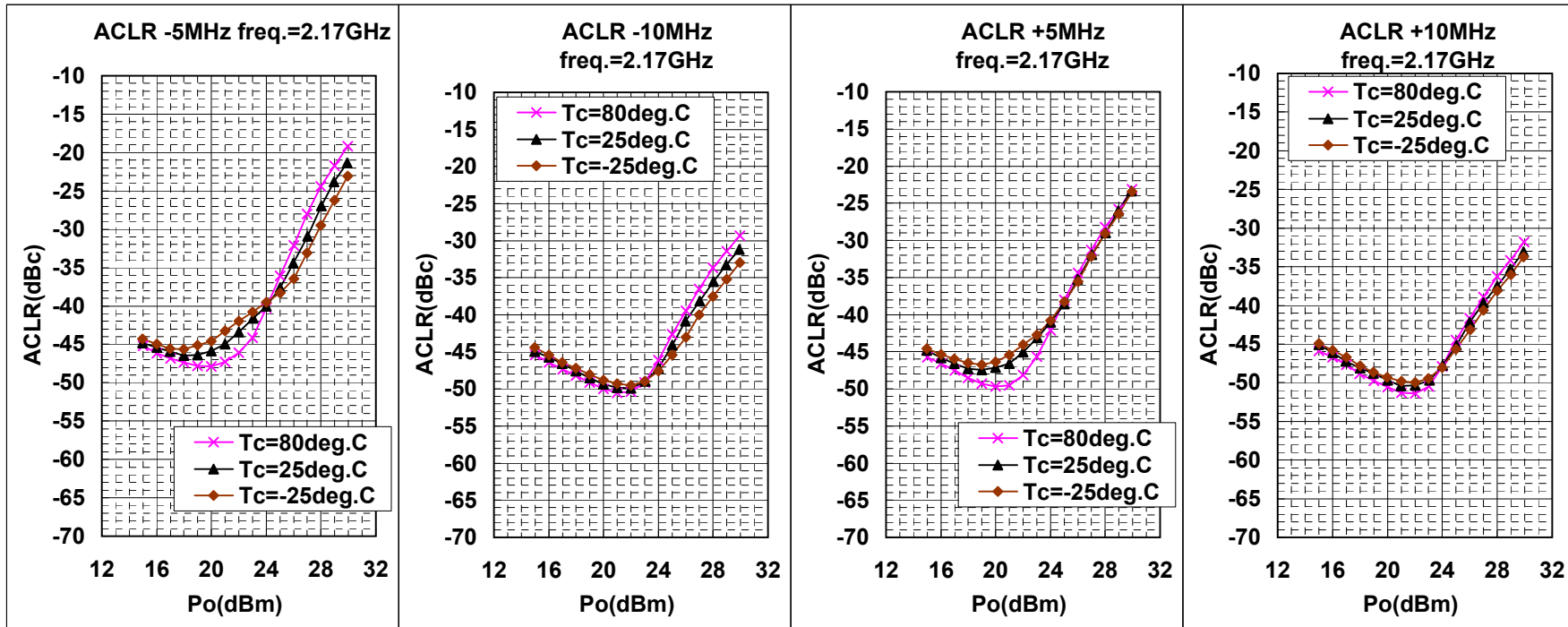

MGF0921A RF TEST DATA(W-CDMA)
ACLR v.s. Po 3GPP TEST MODEL1 64ch's 2carrier Signal

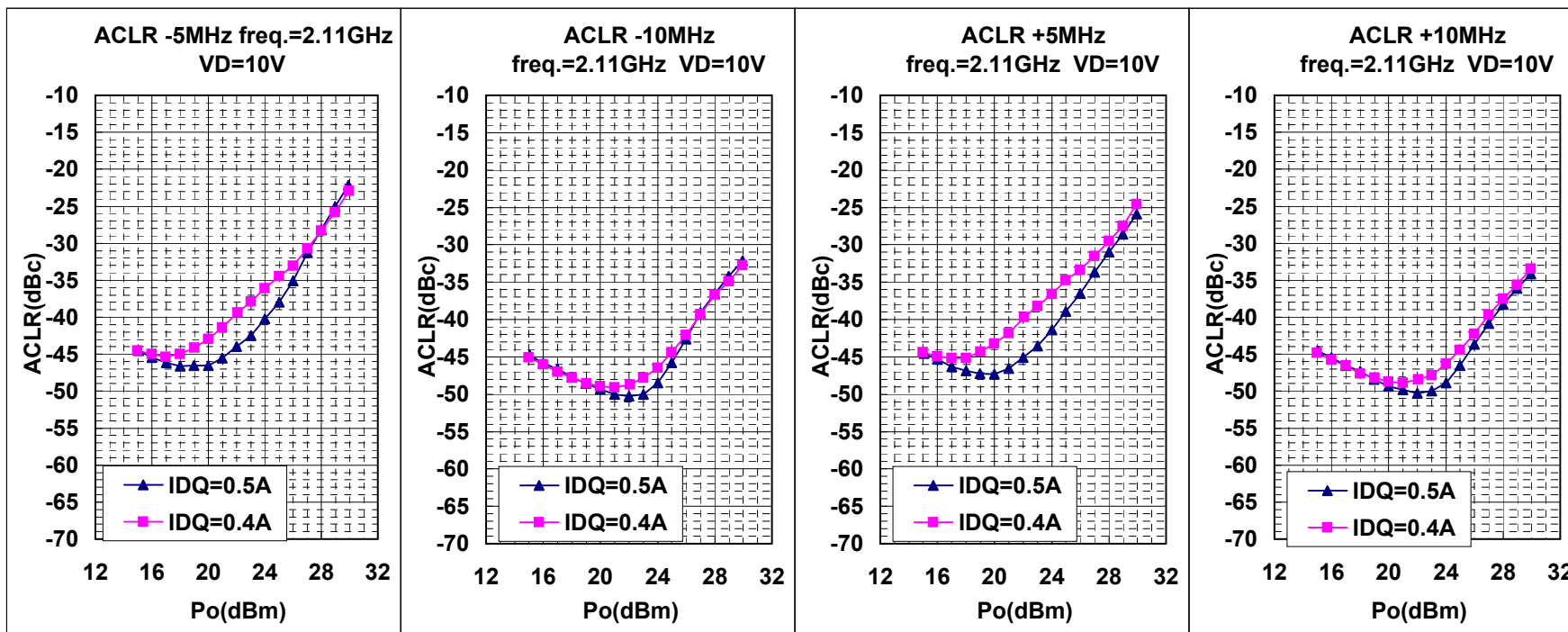

MGF0921A RF TEST DATA(W-CDMA)
ACLR v.s. Po 3GPP TEST MODEL1 64ch's 2carrier Signal

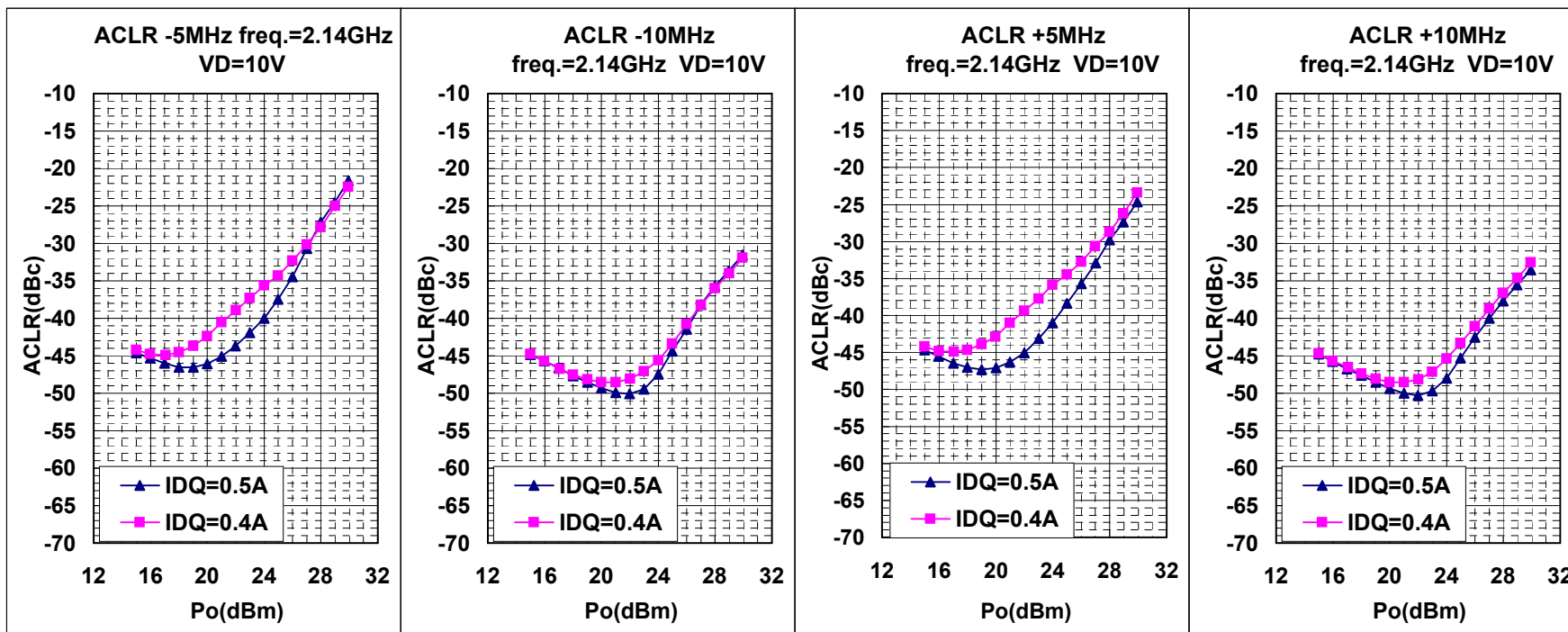

MGF0921A RF TEST DATA(W-CDMA)
ACLR v.s. Po 3GPP TEST MODEL1 64ch's 2carrier Signal

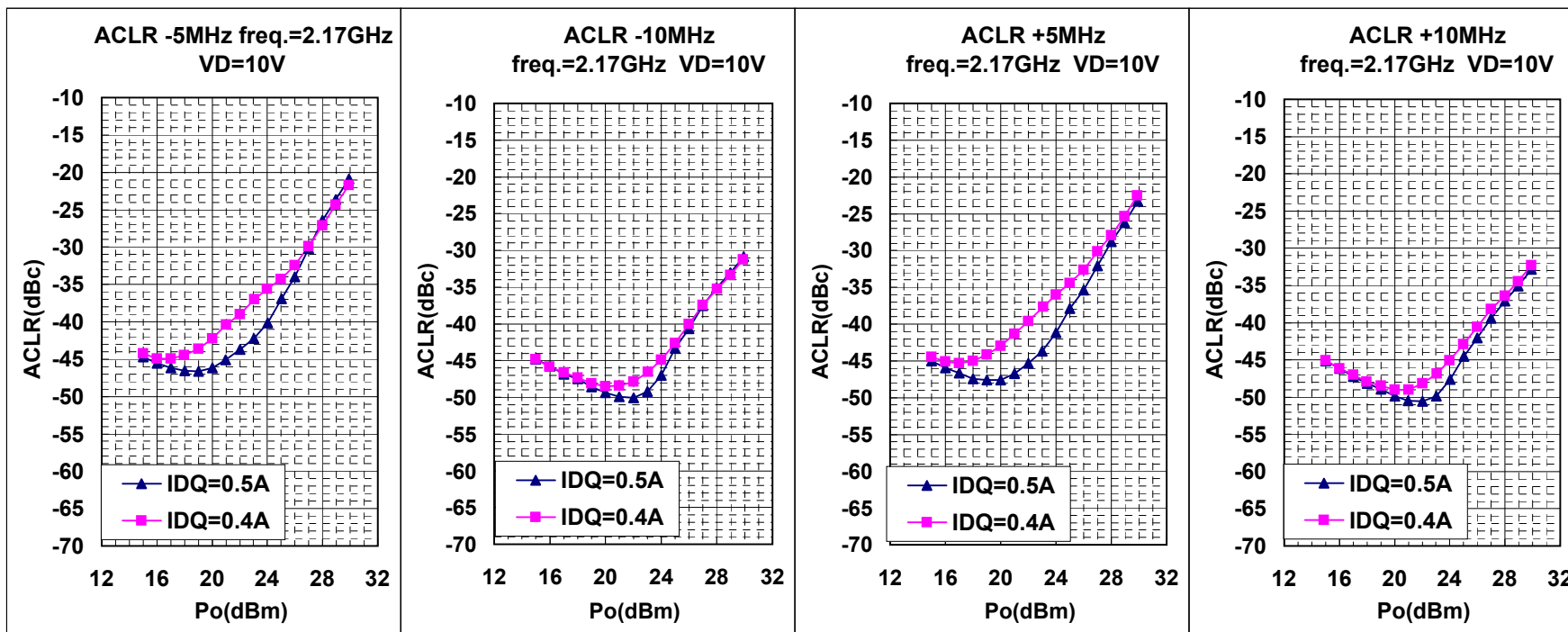

MGF0921A RF TEST DATA(W-CDMA)
ACLR v.s. Po 3GPP TEST MODEL1 64ch's 2carrier Signal

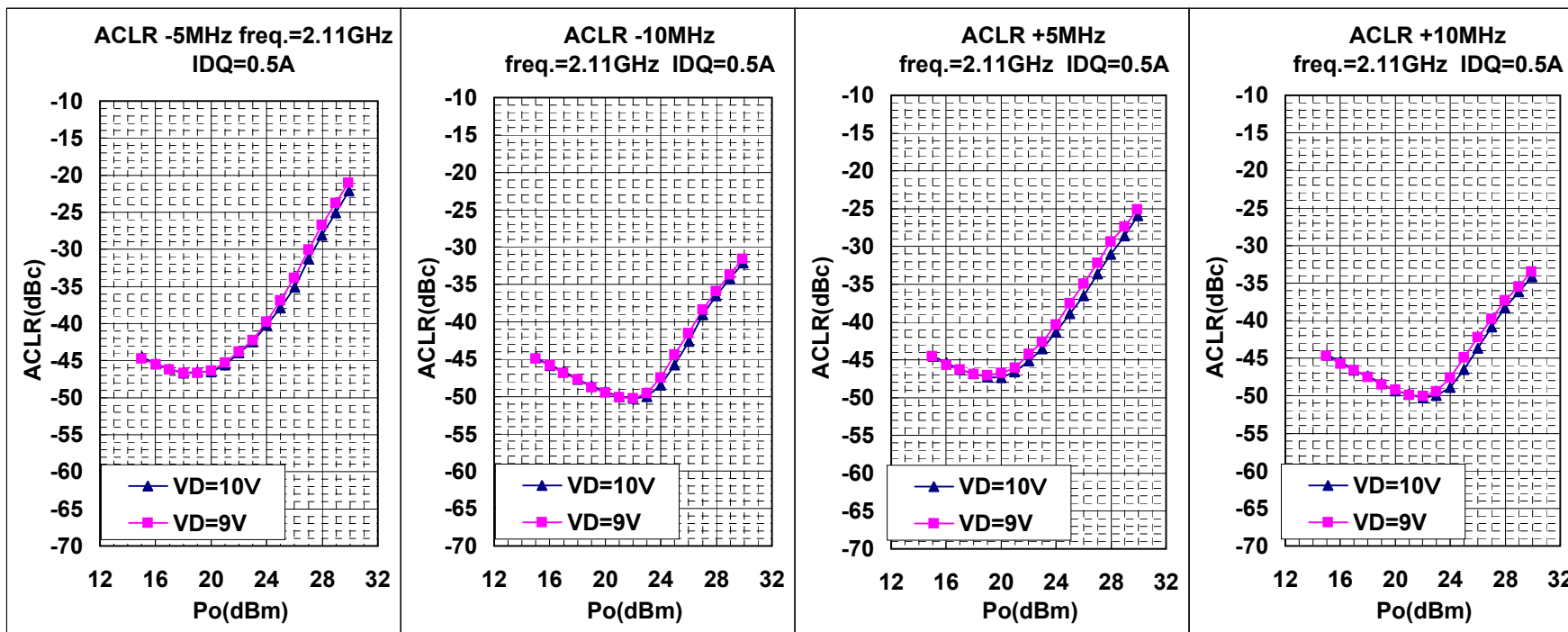

MGF0921A RF TEST DATA(W-CDMA)
ACLR v.s. Po 3GPP TEST MODEL1 64ch's 2carrier Signal

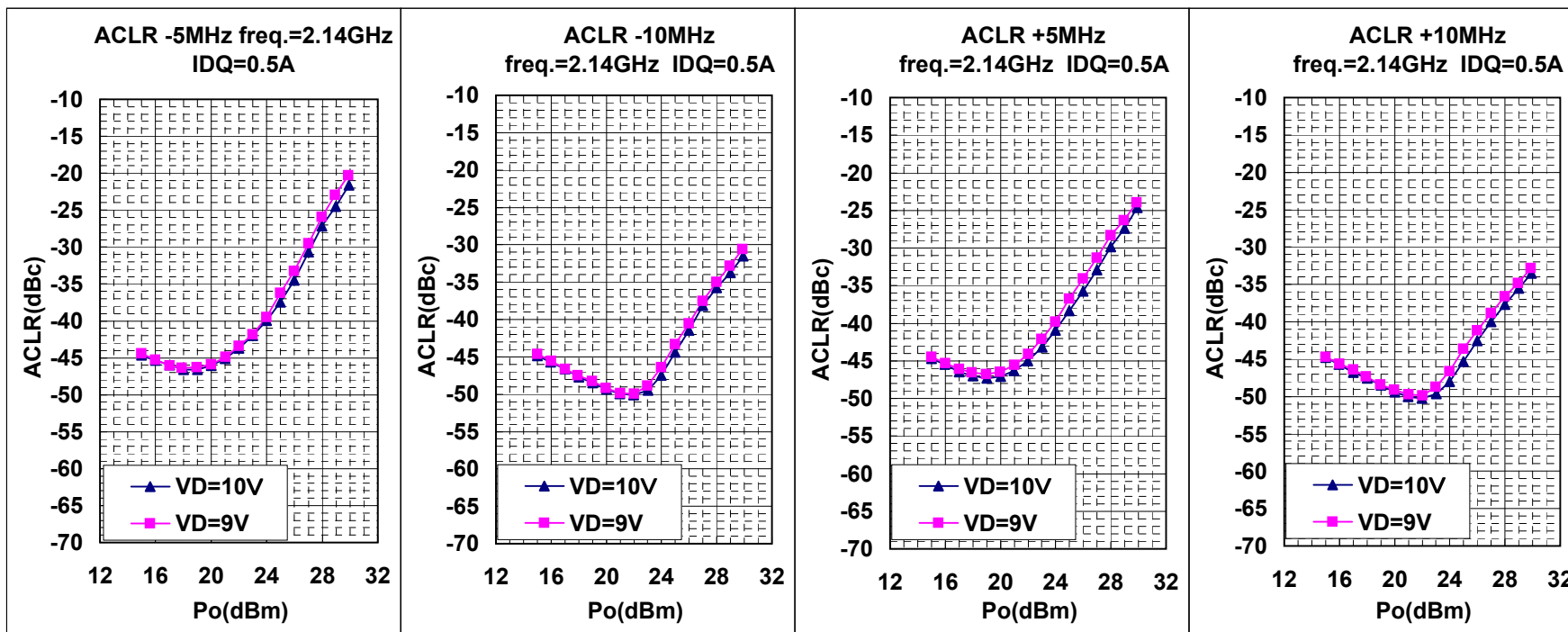

MGF0921A RF TEST DATA(W-CDMA)
ACLR v.s. Po 3GPP TEST MODEL1 64ch's 2carrier Signal

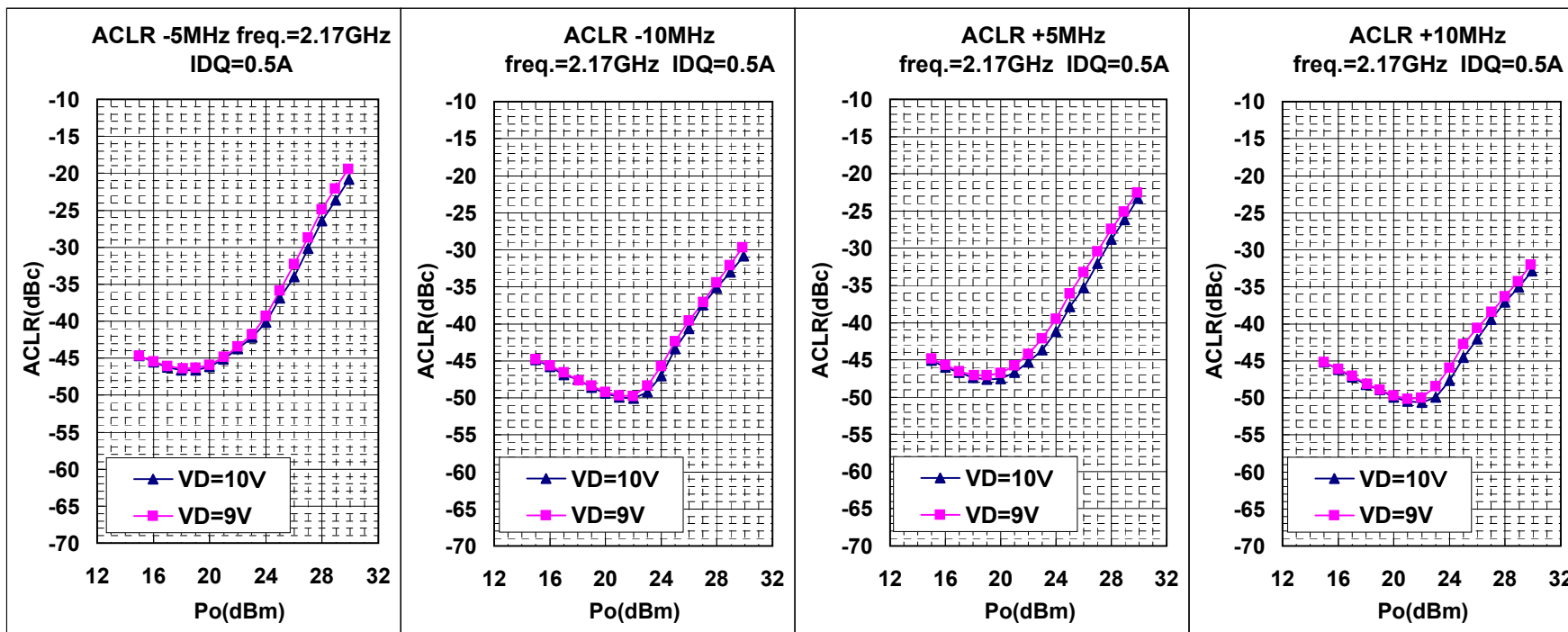

MGF0921A RF TEST DATA VD=10V, IDQ=0.5A
IM3,IM5 v.s. Pin

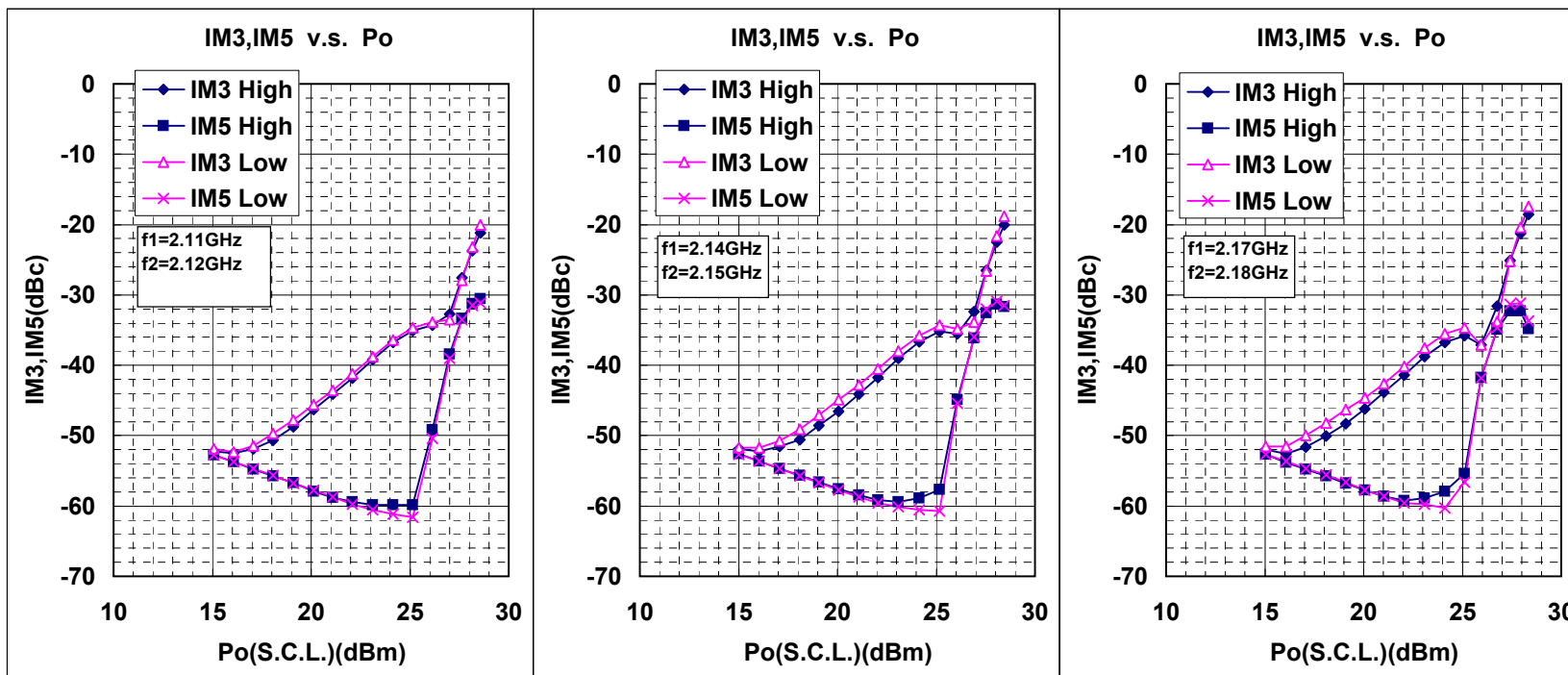

MGF0921A TEST FIXTURE $f=2.11-2.17\text{GHz}$

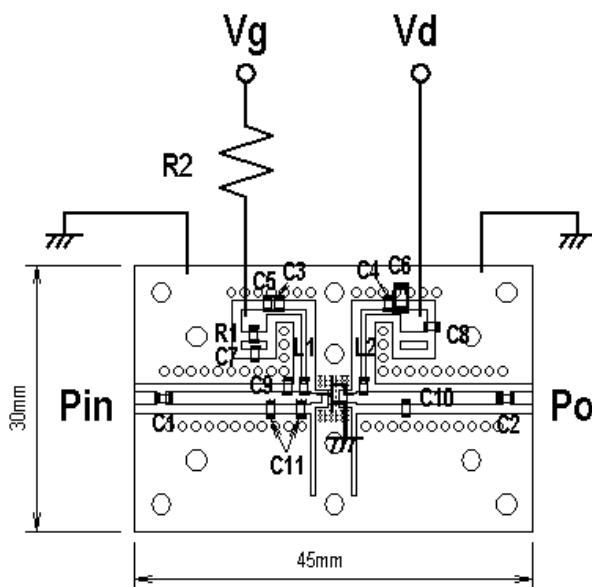

C1, C2, C3, C4=20pF
C5, C7, C8=1000pF
C9, C10, C11=2pF
C6=4.7uF
L1, L2=12nH
R1=51ohm
R2=200ohm

Board material:FR4 Thickness=0.8(mm)
Specific dielectric constant=4.4

L & S BAND GaAs FET [SMD non – matched]**Requests Regarding Safety Designs**

Mitsubishi Electric constantly strives to raise the level of its quality and reliability. Despite these concerted efforts, however, there will be occasions when our semiconductor products suffer breakdowns, malfunctions or other problems. In view of this reality, it is requested that every feasible precaution be taken in the pursuit of redundancy design, malfunction prevention design and other safety-related designs, to prevent breakdowns or malfunctions in our products from resulting in accidents involving people, fires, social losses or other problems, thereby upholding the highest levels of safety in the products when in use by customers.

Matters of Importance when Using these Materials

1. These materials are designed as reference materials to ensure that all customers purchase Mitsubishi Electric semiconductors best suited to their specific use applications. Please be aware, however, that the technical information contained in these materials does not comprise consent for the execution or use of intellectual property rights or other rights owned by Mitsubishi Electric Corporation.
2. Mitsubishi Electric does not assume responsibility for damages resulting from the use of product data, graphs, charts, programs, algorithms or other applied circuit examples described in these materials, or for the infringement of the rights of third-party owners resulting from such use.
3. The data, graphs, charts, programs, algorithms and all other information described in these materials were current at the issue of these materials, with Mitsubishi Electric reserving the right to make any necessary updates or changes in the products or specifications in these materials without prior notice. Before purchasing Mitsubishi Electric semiconductor products, therefore, please obtain the latest available information from Mitsubishi Electric directly or an authorized dealer.
4. Every possible effort has been made to ensure that the information described in these materials is fully accurate. However, Mitsubishi Electric assumes no responsibility for damages resulting from inaccuracies occurring within these materials.
5. When using the product data, technical contents indicated on the graphs, charts, programs or algorithms described in these materials, assessments should not be limited to only the technical contents, programs and algorithm units. Rather, it is requested that ample evaluations be made of each individual system as a whole, with the customer assuming full responsibility for decisions on the propriety of application. Mitsubishi Electric does not accept responsibility for the propriety of application.
6. The products described in these materials, with the exception of special mention concerning use and reliability, have been designed and manufactured with the purpose of use in general electronic machinery. Accordingly these products have not been designed and manufactured with the purpose of application in machinery or systems that will be used under conditions that can affect human life, or in machinery or systems used in social infrastructure that demand a particularly high degree of reliability. When considering the use of the products described in these materials in transportation machinery (automobiles, trains, vessels), for objectives related to medical treatment, aerospace, nuclear power control, submarine repeaters or systems or other specialized applications, please consult with Mitsubishi Electric directly or an authorized dealer.
7. When considering use of products for purposes other than the specific applications described in these materials, please inquire at Mitsubishi Electric or an authorized dealer.
8. The prior consent of Mitsubishi Electric in writing is required for any reprinting or reproduction of these materials.
9. Please direct any inquiries regarding further details of these materials, or any other comments or matters of attention, to Mitsubishi Electric or an authorized dealer.