

Direct Rambus DRAM SO-RIMM™ Module
128M-BYTE (64M-WORD x 18-BIT)**Description**

The Direct Rambus SO-RIMM module is a general-purpose high-performance memory module subsystem suitable for use in a broad range of applications including computer memory, mobile personal computers, networking systems, and other applications where high bandwidth and low latency are required.

MC-4R128FKE8S modules consists of four 288M Direct Rambus DRAM (Direct RDRAM) devices (μ PD488588). These are extremely high-speed CMOS DRAMs organized as 16M words by 18 bits. The use of Rambus Signaling Level (RSL) technology permits 800MHz transfer rates while using conventional system and board design technologies.

Direct RDRAM devices are capable of sustained data transfers at 1.25 ns per two bytes (10 ns per 16 bytes).

The architecture of the Direct RDRAM enables the highest sustained bandwidth for multiple, simultaneous, randomly addressed memory transactions. The separate control and data buses with independent row and column control yield high bus efficiency. The Direct RDRAM's multi-bank architecture supports up to four simultaneous transactions per device.

Features

- 160 edge connector pads with 0.65mm pad spacing
- 128 MB Direct RDRAM storage
- Each RDRAM® has 32 banks, for 128 banks total on module
- Gold plated contacts
- RDRAMs use Chip Scale Package (CSP)
- Serial Presence Detect support
- Operates from a 2.5 V supply
- Powerdown self refresh modes
- Separate Row and Column buses for higher efficiency

**The information in this document is subject to change without notice. Before using this document, please confirm that this is the latest version.
Not all devices/types available in every country. Please check with local Elpida Memory, Inc. for availability and additional information.**

Order information

Part number	Organization	I/O Freq. MHz	RAS access time ns	Package	Mounted devices
MC-4R128FKE8S - 840	64M x 18	800	40	160 edge connector pads SO-RIMM with heat spreader Edge connector: Gold plated	4 pieces of μ PD488588FF FBGA (μ BGA [®]) package

Module Pad Names

Pad	Signal Name	Pad	Signal Name
A1	GND	B1	GND
A2	LDQA8	B2	LDQA7
A3	GND	B3	GND
A4	LDQA6	B4	LDQA5
A5	GND	B5	GND
A6	LDQA4	B6	LDQA3
A7	GND	B7	GND
A8	LDQA2	B8	LDQA1
A9	GND	B9	GND
A10	LDQA0	B10	LCFM
A11	GND	B11	GND
A12	LCTM	B12	LCFMN
A13	GND	B13	GND
A14	LCTMN	B14	LROW2
A15	GND	B15	GND
A16	LROW1	B16	LROW0
A17	GND	B17	GND
A18	LCOL4	B18	LCOL3
A19	GND	B19	GND
A20	LCOL2	B20	LCOL1
A21	GND	B21	GND
A22	LCOL0	B22	LDQB1
A23	GND	B23	GND
A24	LDQB0	B24	LDQB3
A25	GND	B25	GND
A26	LDQB2	B26	LDQB5
A27	GND	B27	GND
A28	LDQB4	B28	LDQB7
A29	GND	B29	GND
A30	LDQB6	B30	LDQB8
A31	GND	B31	GND
A32	LSCK	B32	LCMD
A33	GND	B33	GND
A34	SOUT	B34	SIN
A35	V _{DD}	B35	V _{DD}
A36	NC	B36	NC
A37	GND	B37	GND
A38	NC	B38	NC
A39	V _{CMOS}	B39	V _{CMOS}
A40	NC	B40	NC

Pad	Signal Name	Pad	Signal Name
A41	NC	B41	NC
A42	V _{REF}	B42	V _{REF}
A43	SCL	B43	SA0
A44	V _{DD}	B44	V _{DD}
A45	SDA	B45	SA1
A46	V _{DD}	B46	V _{DD}
A47	SV _{DD}	B47	SWP
A48	GND	B48	GND
A49	RSCK	B49	RCMD
A50	GND	B50	GND
A51	RDQB8	B51	RDQB6
A52	GND	B52	GND
A53	RDQB7	B53	RDQB4
A54	GND	B54	GND
A55	RDQB5	B55	RDQB2
A56	GND	B56	GND
A57	RDQB3	B57	RDQB0
A58	GND	B58	GND
A59	RDQB1	B59	RCOL0
A60	GND	B60	GND
A61	RCOL1	B61	RCOL2
A62	GND	B62	GND
A63	RCOL3	B63	RCOL4
A64	GND	B64	GND
A65	RROW0	B65	RROW1
A66	GND	B66	GND
A67	RROW2	B67	RCTMN
A68	GND	B68	GND
A69	RCFMN	B69	RCTM
A70	GND	B70	GND
A71	RCFM	B71	RDQA0
A72	GND	B72	GND
A73	RDQA1	B73	RDQA2
A74	GND	B74	GND
A75	RDQA3	B75	RDQA4
A76	GND	B76	GND
A77	RDQA5	B77	RDQA6
A78	GND	B78	GND
A79	RDQA7	B79	RDQA8
A80	GND	B80	GND

Module Connector Pad Description

(1/2)

Signal	I/O	Type	Description
GND	–	–	Ground reference for RDRAM core and interface.
LCFM	I	RSL	Clock from master. Interface clock used for receiving RSL signals from the Channel. Positive polarity.
LCFMN	I	RSL	Clock from master. Interface clock used for receiving RSL signals from the Channel. Negative polarity.
LCMD	I	V _{CMOS}	Serial Command used to read from and write to the control registers. Also used for power management.
LCOL4..LCOLO	I	RSL	Column bus. 5-bit bus containing control and address information for column accesses.
LCTM	I	RSL	Clock to master. Interface clock used for transmitting RSL signals to the Channel. Positive polarity.
LCTMN	I	RSL	Clock to master. Interface clock used for transmitting RSL signals to the Channel. Negative polarity.
LDQA8..LDQA0	I/O	RSL	Data bus A. A 9-bit bus carrying a byte of read or write data between the Channel and the RDRAM. LDQA8 is non-functional on modules with x16 RDRAM devices.
LDQB8..LDQB0	I/O	RSL	Data bus B. A 9-bit bus carrying a byte of read or write data between the Channel and the RDRAM. LDQB8 is non-functional on modules with x16 RDRAM devices.
LROW2..LROW0	I	RSL	Row bus. 3-bit bus containing control and address information for row accesses.
LSCK	I	V _{CMOS}	Serial clock input. Clock source used to read from and write to the RDRAM control registers.
NC	–	–	These pads are not connected. These 8 connector pads are reserved for future use.
RCFM	I	RSL	Clock from master. Interface clock used for receiving RSL signals from the Channel. Positive polarity.
RCFMN	I	RSL	Clock from master. Interface clock used for receiving RSL signals from the Channel. Negative polarity.
RCMD	I	V _{CMOS}	Serial Command Input used to read from and write to the control registers. Also used for power management.
RCOL4..RCOLO	I	RSL	Column bus. 5-bit bus containing control and address information for column accesses.
RCTM	I	RSL	Clock to master. Interface clock used for transmitting RSL signals to the Channel. Positive polarity.
RCTMN	I	RSL	Clock to master. Interface clock used for transmitting RSL signals to the Channel. Negative polarity.
RDQA8..RDQA0	I/O	RSL	Data bus A. A 9-bit bus carrying a byte of read or write data between the Channel and the RDRAM. RDQA8 is non-functional on modules with x16 RDRAM devices.
RDQB8..RDQB0	I/O	RSL	Data bus B. A 9-bit bus carrying a byte of read or write data between the Channel and the RDRAM. RDQB8 is non-functional on modules with x16 RDRAM devices.
RROW2..RROW0	I	RSL	Row bus. 3-bit bus containing control and address information for row accesses.

(2/2)

Signal	I/O	Type	Description
RCLK	I	V _{CMOS}	Serial clock input. Clock source used to read from and write to the RDRAM control registers.
SA0	I	V _{DD}	Serial Presence Detect Address 0.
SA1	I	V _{DD}	Serial Presence Detect Address 1.
SCL	I	V _{DD}	Serial Presence Detect Clock.
SDA	I/O	V _{DD}	Serial Presence Detect Data (Open Collector I/O).
SIN	I/O	V _{CMOS}	Serial I/O for reading from and writing to the control registers. Attaches to SIO0 of the first RDRAM on the module.
SOUT	I/O	V _{CMOS}	Serial I/O for reading from and writing to the control registers. Attaches to SIO1 of the last RDRAM on the module.
V _{DD}	—	—	SPD Voltage. Used for signals SCL, SDA, SWP, SA0, SA1 and SA2.
SWP	I	V _{DD}	Serial Presence Detect Write Protect (active high). When low, the SPD can be written as well as read.
V _{CMOS}	—	—	CMOS I/O Voltage. Used for signals CMD, SCK, SIN, SOUT.
V _{DD}	—	—	Supply voltage for the RDRAM core and interface logic.
V _{REF}	—	—	Logic threshold reference voltage for RSL signals.

Block Diagram

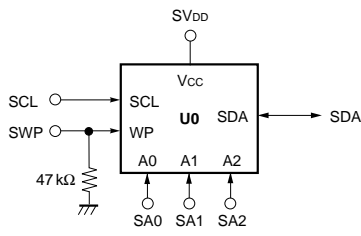
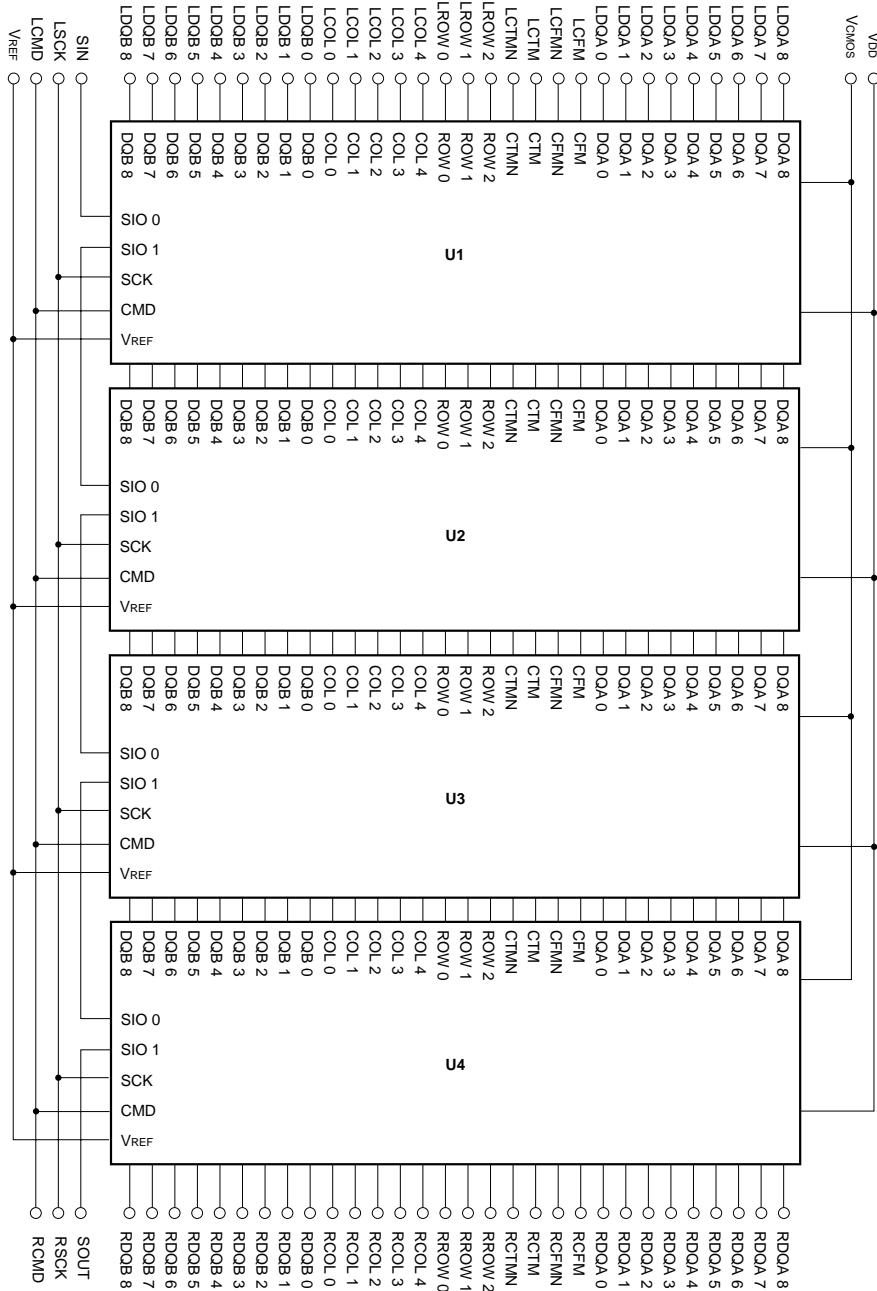

SERIAL PD

- Remarks**
1. Rambus Channel signals form a loop through the SO-RIMM module, with the exception of the SIO chain.
 2. See Serial Presence Detection Specification for information on the SPD device and its contents.

Electrical Specification

Absolute Maximum Ratings

Symbol	Parameter	MIN.	MAX.	Unit
$V_{I,ABS}$	Voltage applied to any RSL or CMOS signal pad with respect to GND	-0.3	$V_{DD} + 0.3$	V
$V_{DD,ABS}$	Voltage on V_{DD} with respect to GND	-0.5	$V_{DD} + 1.0$	V
T_{STORE}	Storage temperature	-50	+100	°C

Caution Exposing the device to stress above those listed in Absolute Maximum Ratings could cause permanent damage. The device is not meant to be operated under conditions outside the limits described in the operational section of this specification. Exposure to Absolute Maximum Rating conditions for extended periods may affect device reliability.

DC Recommended Electrical Conditions

Symbol	Parameter and conditions	MIN.	MAX.	Unit
V_{DD}	Supply voltage	2.50 - 0.13	2.50 + 0.13	V
V_{CMOS}	CMOS I/O power supply at pad	2.5V controllers	V_{DD}	V_{DD}
		1.8V controllers	1.8 - 0.1	1.8 + 0.2
V_{REF}	Reference voltage	1.4 - 0.2	1.4 + 0.2	V
V_{SPD}	Serial presence detector-positive power supply	2.2	3.6	V
V_{IL}	RSL input low voltage	$V_{REF} - 0.5$	$V_{REF} - 0.2$	V
V_{IH}	RSL input high voltage	$V_{REF} + 0.2$	$V_{REF} + 0.5$	V
$V_{IL,CMOS}$	CMOS input low voltage	-0.3	$0.5V_{CMOS} - 0.25$	V
$V_{IH,CMOS}$	CMOS input high voltage	$0.5V_{CMOS} + 0.25$	$V_{CMOS} + 0.3$	V
$V_{OL,CMOS}$	CMOS output low voltage, $I_{OL,CMOS} = 1\text{ mA}$	—	0.3	V
$V_{OH,CMOS}$	CMOS output high voltage, $I_{OH,CMOS} = -0.25\text{ mA}$	$V_{CMOS} - 0.3$	—	V
I_{REF}	V_{REF} current, $V_{REF,MAX}$	-40.0	+40.0	μA
$I_{SCK,CMD}$	CMOS input leakage current, ($0 \leq V_{CMOS} \leq V_{DD}$)	-40.0	+40.0	μA
$I_{SIN,SOUT}$	CMOS input leakage current, ($0 \leq V_{CMOS} \leq V_{DD}$)	-10.0	+10.0	μA

AC Electrical Specifications

Symbol	Parameter and Conditions	MIN.	TYP.	MAX.	Unit
Z	Module Impedance of RSL signals	25.2	28.0	30.8	Ω
	Module Impedance of SCK and CMD signals	23.8	28.0	32.2	
T _{PD}	Average clock delay from finger to finger of all RSL clock nets (CTM, CTMN,CFM, and CFMN)			1.06	ns
ΔT _{PD}	Propagation delay variation of RSL signals with respect to T _{PD} ^{Note1,2}	-21		+21	ps
ΔT _{PD-CMOS}	Propagation delay variation of SCK signal with respect to an average clock delay ^{Note1}	-250		+250	ps
ΔT _{PD-SCK,CMD}	Propagation delay variation of CMD signal with respect to SCK signal	-200		+200	ps
V _ω /V _{IN}	Attenuation Limit	-840		12.0	%
V _{XF} /V _{IN}	Forward crosstalk coefficient	-840		2.0	%
V _{XB} /V _{IN}	Backward crosstalk coefficient	-840		1.5	%
R _{DC}	DC Resistance Limit	-840		0.9	Ω

- Notes 1.** T_{PD} or Average clock delay is defined as the average delay from finger to finger of all RSL clock nets (CTM, CTMN, CFM, and CFMN).
- 2.** If the SO-RIMM module meets the following specification, then it is compliant to the specification.
If the SO-RIMM module does not meet these specifications, then the specification can be adjusted by the “Adjusted ΔT_{PD} Specification” table.

Adjusted ΔT_{PD} Specification

Symbol	Parameter and conditions	Adjusted MIN./MAX.	Absolute		Unit
			MIN.	MAX.	
ΔT _{PD}	Propagation delay variation of RSL signals with respect to T _{PD}	+/- [17+(18*N*ΔZ0)] ^{Note}	-30	+30	ps

Note N = Number of RDRAM devices installed on the SO-RIMM module.
 $\Delta Z0 = \text{delta } Z0\% = (\text{MAX. } Z0 - \text{MIN. } Z0) / (\text{MIN. } Z0)$
 (MAX. Z0 and MIN. Z0 are obtained from the loaded (high impedance) impedance coupons of all RSL layers on the module.)

SO-RIMM Module Current Profile

I _{DD}	RIMM module power conditions ^{Note1}		MAX.	Unit
I _{DD1}	One RDRAM in Read ^{Note2} , balance in NAP mode	-840	717.6	mA
I _{DD2}	One RDRAM in Read ^{Note2} , balance in Standby mode	-840	975	mA
I _{DD3}	One RDRAM in Read ^{Note2} , balance in Active mode	-840	1110	mA
I _{DD4}	One RDRAM in Write, balance in NAP mode	-840	777.6	mA
I _{DD5}	One RDRAM in Write, balance in Standby mode	-840	1035	mA
I _{DD6}	One RDRAM in Write, balance in Active mode	-840	1170	mA

Notes 1. Actual power will depend on individual RDRAM component specifications, memory controller and usage patterns. Power does not include Refresh Current.

2. I/O current is a function of the % of 1's, to add I/O power for 50 % 1's for a x16 need to add 257 mA or 290 mA for x18 ECC module for the following : V_{DD} = 2.5 V, V_{TERM} = 1.8 V, V_{REF} = 1.4 V and V_{DIL} = V_{REF} – 0.5 V.

Package Drawings

160 EDGE CONNECTOR PADS RIMM (SOCKET TYPE) (1/2)

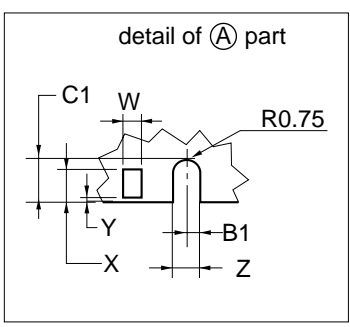
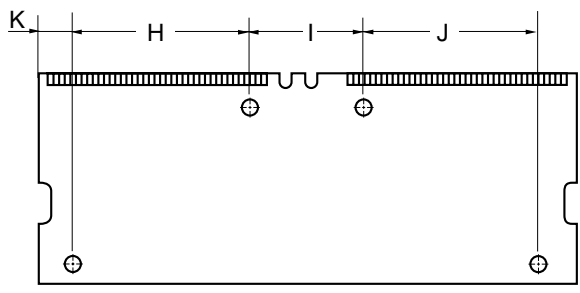
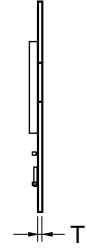
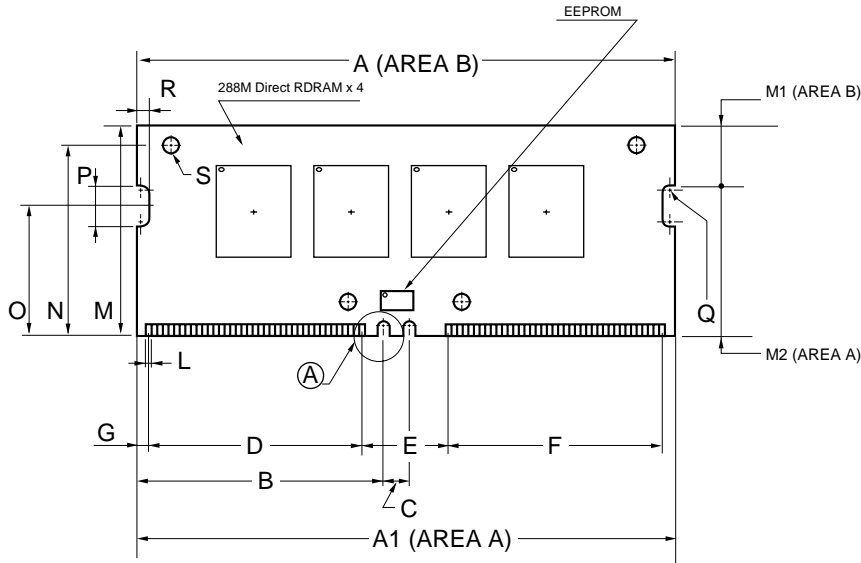

ITEM	MILLIMETERS
A	67.60 TYP.
A1	67.60 ± 0.15
B	30.00
B1	0.75 ± 0.10
C	4.00
C1	4.00 ± 0.10
D	25.35
E	13.60
F	25.35
G	1.65
H	21.00
I	17.00
J	21.00
K	4.30
L	0.65 TYP.
M	31.25 ± 0.15
M1	8.75
M2	22.50
N	29.25
O	20.00
P	5.00 ± 0.10
Q	R1.00
R	1.00 ± 0.10
S	φ2.00
T	1.0 ± 0.10
W	0.43 ± 0.03
X	2.55 MIN.
Y	0.25 MAX.
Z	1.50 ± 0.10

ECA-TS2-0034-02

160 EDGE CONNECTOR PADS RIMM (SOCKET TYPE) (2/2)

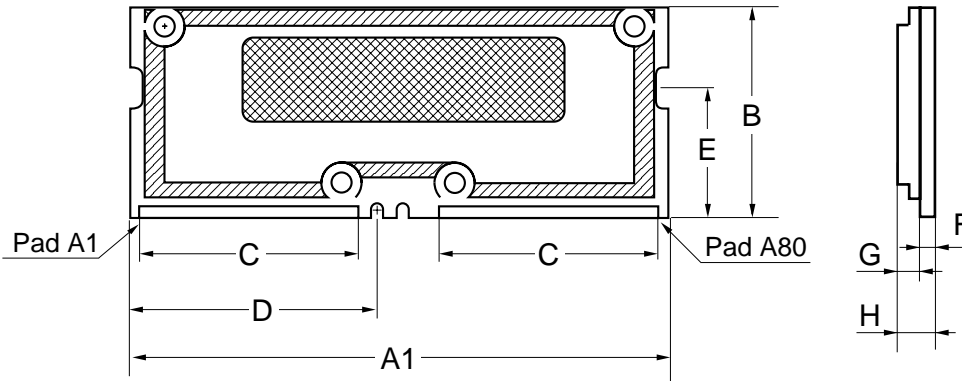

ITEM	DESCRIPTION	MIN.	TYP.	MAX.	UNIT
A1	PCB length	67.45	67.60	67.75	mm
B	PCB height	31.10	31.25	31.40	mm
C	Center-center pad width from pad A1 to A40, A41 to A80, B1 to B40 or B41 to B80	-	25.35	-	mm
D	Spacing from PCB left edge to connector key notch	-	30.00	-	mm
E	Spacing from contact pad PCB edge to side edge retainer notch	-	20.00	-	mm
F	PCB thickness	0.90	1.00	1.10	mm
G	Heat spreader thickness from PCB surface (one side) to heat spreader top surface	-	1.35	-	mm
H	RIMM thickness	-	2.35	-	mm

ECA-TS2-0034-02

CAUTION FOR HANDLING MEMORY MODULES

When handling or inserting memory modules, be sure not to touch any components on the modules, such as the memory ICs, chip capacitors and chip resistors. It is necessary to avoid undue mechanical stress on these components to prevent damaging them.

In particular, do not push module cover or drop the modules in order to protect from mechanical defects, which would be electrical defects.

When re-packing memory modules, be sure the modules are not touching each other.

Modules in contact with other modules may cause excessive mechanical stress, which may damage the modules.

MDE0202

NOTES FOR CMOS DEVICES**① PRECAUTION AGAINST ESD FOR MOS DEVICES**

Exposing the MOS devices to a strong electric field can cause destruction of the gate oxide and ultimately degrade the MOS devices operation. Steps must be taken to stop generation of static electricity as much as possible, and quickly dissipate it, when once it has occurred. Environmental control must be adequate. When it is dry, humidifier should be used. It is recommended to avoid using insulators that easily build static electricity. MOS devices must be stored and transported in an anti-static container, static shielding bag or conductive material. All test and measurement tools including work bench and floor should be grounded. The operator should be grounded using wrist strap. MOS devices must not be touched with bare hands. Similar precautions need to be taken for PW boards with semiconductor MOS devices on it.

② HANDLING OF UNUSED INPUT PINS FOR CMOS DEVICES

No connection for CMOS devices input pins can be a cause of malfunction. If no connection is provided to the input pins, it is possible that an internal input level may be generated due to noise, etc., hence causing malfunction. CMOS devices behave differently than Bipolar or NMOS devices. Input levels of CMOS devices must be fixed high or low by using a pull-up or pull-down circuitry. Each unused pin should be connected to V_{DD} or GND with a resistor, if it is considered to have a possibility of being an output pin. The unused pins must be handled in accordance with the related specifications.

③ STATUS BEFORE INITIALIZATION OF MOS DEVICES

Power-on does not necessarily define initial status of MOS devices. Production process of MOS does not define the initial operation status of the device. Immediately after the power source is turned ON, the MOS devices with reset function have not yet been initialized. Hence, power-on does not guarantee output pin levels, I/O settings or contents of registers. MOS devices are not initialized until the reset signal is received. Reset operation must be executed immediately after power-on for MOS devices having reset function.

CME0107

Rambus, RDRAM and the Rambus logo are registered trademarks of Rambus Inc.

RIMM, SO-RIMM, RaSer and QRSL are trademarks of Rambus Inc.

μBGA is a registered trademark of Tessera, Inc.

The information in this document is subject to change without notice. Before using this document, confirm that this is the latest version.

No part of this document may be copied or reproduced in any form or by any means without the prior written consent of Elpida Memory, Inc.

Elpida Memory, Inc. does not assume any liability for infringement of any intellectual property rights (including but not limited to patents, copyrights, and circuit layout licenses) of Elpida Memory, Inc. or third parties by or arising from the use of the products or information listed in this document. No license, express, implied or otherwise, is granted under any patents, copyrights or other intellectual property rights of Elpida Memory, Inc. or others.

Descriptions of circuits, software and other related information in this document are provided for illustrative purposes in semiconductor product operation and application examples. The incorporation of these circuits, software and information in the design of the customer's equipment shall be done under the full responsibility of the customer. Elpida Memory, Inc. assumes no responsibility for any losses incurred by customers or third parties arising from the use of these circuits, software and information.

[Product applications]

Elpida Memory, Inc. makes every attempt to ensure that its products are of high quality and reliability. However, users are instructed to contact Elpida Memory's sales office before using the product in aerospace, aeronautics, nuclear power, combustion control, transportation, traffic, safety equipment, medical equipment for life support, or other such application in which especially high quality and reliability is demanded or where its failure or malfunction may directly threaten human life or cause risk of bodily injury.

[Product usage]

Design your application so that the product is used within the ranges and conditions guaranteed by Elpida Memory, Inc., including the maximum ratings, operating supply voltage range, heat radiation characteristics, installation conditions and other related characteristics. Elpida Memory, Inc. bears no responsibility for failure or damage when the product is used beyond the guaranteed ranges and conditions. Even within the guaranteed ranges and conditions, consider normally foreseeable failure rates or failure modes in semiconductor devices and employ systemic measures such as fail-safes, so that the equipment incorporating Elpida Memory, Inc. products does not cause bodily injury, fire or other consequential damage due to the operation of the Elpida Memory, Inc. product.

[Usage environment]

This product is not designed to be resistant to electromagnetic waves or radiation. This product must be used in a non-condensing environment.

If you export the products or technology described in this document that are controlled by the Foreign Exchange and Foreign Trade Law of Japan, you must follow the necessary procedures in accordance with the relevant laws and regulations of Japan. Also, if you export products/technology controlled by U.S. export control regulations, or another country's export control laws or regulations, you must follow the necessary procedures in accordance with such laws or regulations.

If these products/technology are sold, leased, or transferred to a third party, or a third party is granted license to use these products, that third party must be made aware that they are responsible for compliance with the relevant laws and regulations.

M01E0107