

$$I_{F(AV)} = 40\text{Amp}$$

$$V_R = 15\text{V}$$

**Major Ratings and Characteristics**

Characteristics	Value	Units
$I_{F(AV)}$ Rectangular waveform	40	A
$V_{RRM}$	15	V
$I_{FSM}$ @tp = 5 $\mu$ s sine	700	A
$V_F$ @20Apk, $T_J=125^\circ\text{C}$ (per leg, Typical)	0.26	V
$T_J$	-55 to 125	$^\circ\text{C}$

**Description/ Features**

The MBR40L15CW center tap Schottky rectifier module has been optimized for ultra low forward voltage drop specifically for the OR-ing of parallel power supplies. The proprietary barrier technology allows for reliable operation up to 125  $^\circ\text{C}$  junction temperature. Typical applications are in parallel switching power supplies, converters, reverse battery protection, and redundant power subsystems.

- 125 $^\circ\text{C}$   $T_J$  operation ( $V_R < 5\text{V}$ )
- Center tap module
- Optimized for OR-ing applications
- Ultra low forward voltage drop
- High frequency operation
- Guard ring for enhanced ruggedness and long term reliability
- High purity, high temperature epoxy encapsulation for enhanced mechanical strength and moisture resistance

**Case Styles**



TO-247AC

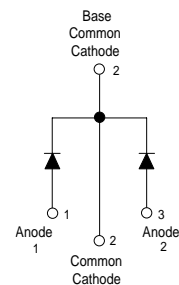

# MBR40L15CW

Bulletin PD-20623 rev. B 10/06



## Voltage Ratings

Part number	MBR40L15CW	
$V_R$ Max. DC Reverse Voltage (V) @ $T_J = 100^\circ\text{C}$	15	
$V_{RWM}$ Max. Working Peak Reverse Voltage (V) @ $T_J = 100^\circ\text{C}$	15	

## Absolute Maximum Ratings

Parameters	Value	Units	Conditions
$I_{F(AV)}$ Max. Average Forward Current (Per Leg) * See Fig. 5 (Per Device)	20	A	50% duty cycle @ $T_C = 86^\circ\text{C}$ , rectangular wave form
	40		
$I_{FSM}$ Max. Peak One Cycle Non-Repetitive Surge Current (Per Leg) * See Fig. 7	700	A	5 $\mu\text{s}$ Sine or 3 $\mu\text{s}$ Rect. pulse
	330		10ms Sine or 6ms Rect. pulse
$E_{AS}$ Non-Repetitive Avalanche Energy (Per Leg)	5	mJ	$T_J = 25^\circ\text{C}$ , $I_{AS} = 2$ Amps, $L = 6$ mH
$I_{AR}$ Repetitive Avalanche Current (Per Leg)	2	A	Current decaying linearly to zero in 1 $\mu\text{sec}$ Frequency limited by $T_J$ max. $V_A = 1.5 \times V_R$ typical

## Electrical Specifications

Parameters	Value		Units	Conditions		
	Typ.	Max.				
$V_{FM}$ Forward Voltage Drop (Per Leg) * See Fig. 1 (1)		0.42	V	@ 20A	$T_J = 25^\circ\text{C}$	
		0.52	V	@ 40A		
		0.26	0.34	V	@ 20A	$T_J = 125^\circ\text{C}$
		0.37	0.50	V	@ 40A	
$I_{RM}$ Reverse Leakage Current (Per Leg) * See Fig. 2 (1)	-	10	mA	$T_J = 25^\circ\text{C}$	$V_R = \text{rated } V_R$	
	-	600	mA	$T_J = 100^\circ\text{C}$		
$V_{F(TO)}$ Threshold Voltage	0.182		V	$T_J = T_J \text{ max.}$		
$r_t$ Forward Slope Resistance	7.6		m $\Omega$			
$C_T$ Max. Junction Capacitance(Per Leg)	-	2000	pF	$V_R = 5V_{DC}$ , (test signal range 100Khz to 1Mhz) $25^\circ\text{C}$		
$L_S$ Typical Series Inductance (Per Leg)	8	-	nH	Measured lead to lead 5mm from package body		
dv/dt Max. Voltage Rate of Change (Rated $V_R$ )	10000		V/ $\mu\text{s}$			

(1) Pulse Width < 300 $\mu\text{s}$ , Duty Cycle <2%

## Thermal-Mechanical Specifications

Parameters	Value	Units	Conditions
$T_J$ Max. Junction Temperature Range	-55 to 125	$^\circ\text{C}$	
$T_{stg}$ Max. Storage Temperature Range	-55 to 150	$^\circ\text{C}$	
$R_{thJC}$ Max. Thermal Resistance Junction to Case (Per Leg)	1.4	$^\circ\text{C/W}$	DC operation * See Fig. 4
$R_{thJC}$ Max. Thermal Resistance Junction to Case (Per Package)	0.7	$^\circ\text{C/W}$	DC operation
$R_{thCS}$ Typical Thermal Resistance, Case to Heatsink	0.24	$^\circ\text{C/W}$	Mounting surface, smooth and greased
wt Approximate Weight	6 (0.21)	g (oz.)	
T Mounting Torque	Min.	6 (5)	Non-lubricated threads
	Max.	12 (10)	
Case Style	TO-247AC (TO-3P)	JEDEC	

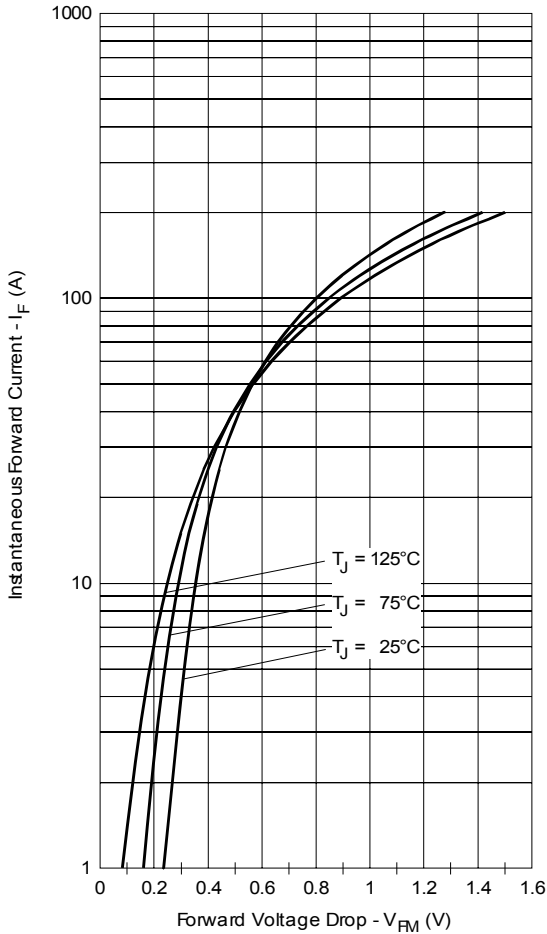

Fig. 1 - Maximum Forward Voltage Drop Characteristics

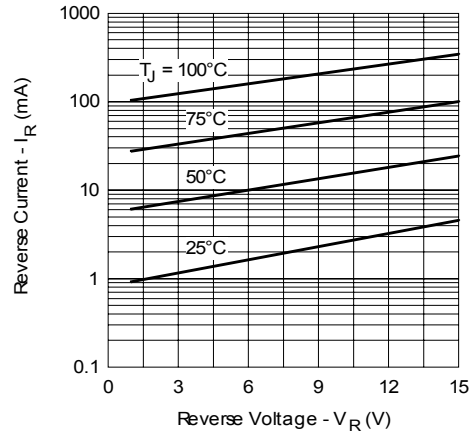

Fig. 2 - Typical Values of Reverse Current Vs. Reverse Voltage

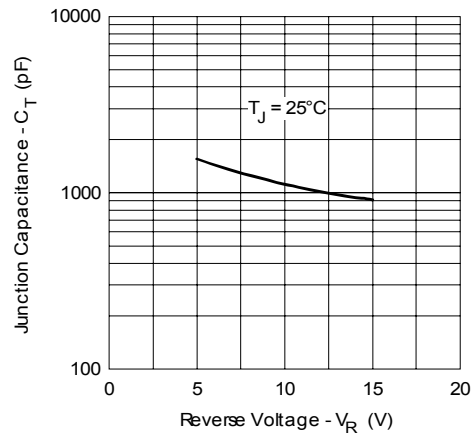

Fig. 3 - Typical Junction Capacitance Vs. Reverse Voltage

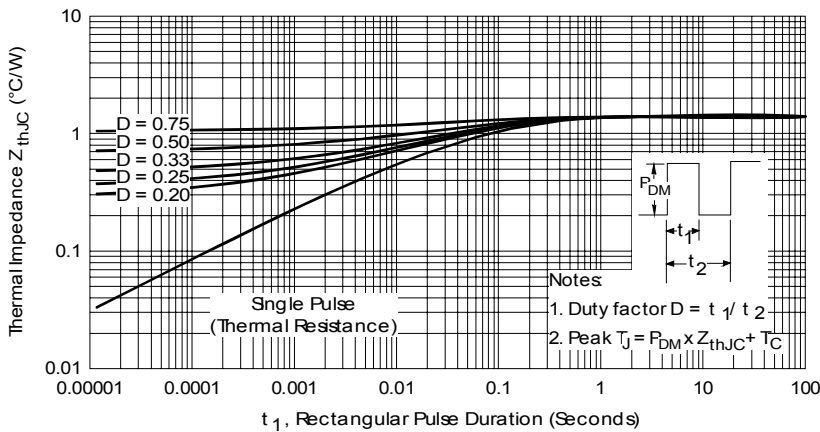

Fig. 4 - Maximum Thermal Impedance  $Z_{thJC}$  Characteristics

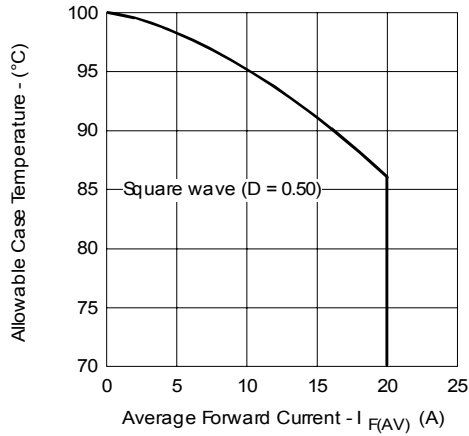

Fig. 5 - Maximum Allowable Case Temperature Vs. Average Forward Current

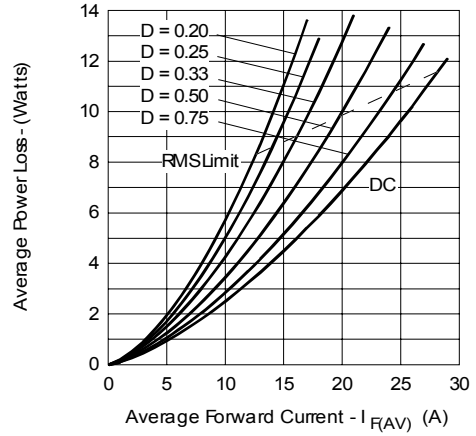

Fig. 6 - Forward Power Loss Characteristics

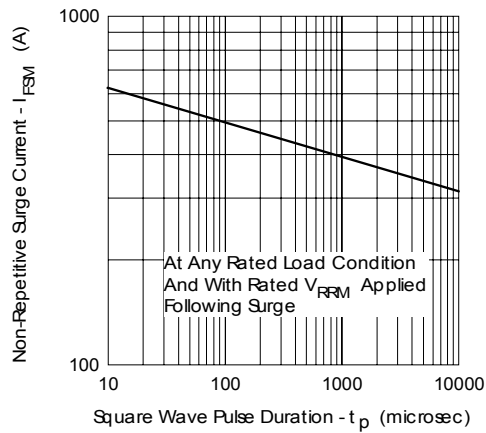

Fig. 7 - Maximum Non-Repetitive Surge Current

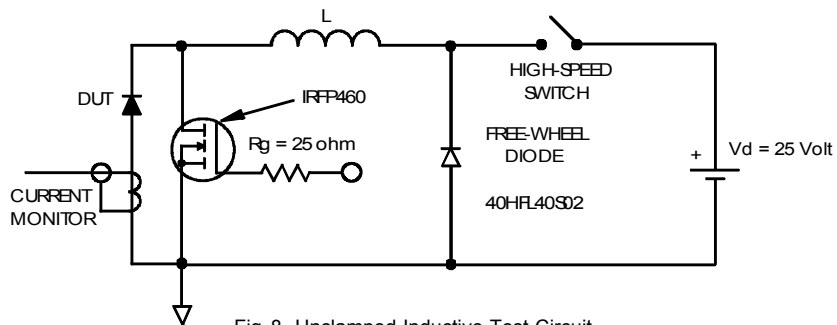
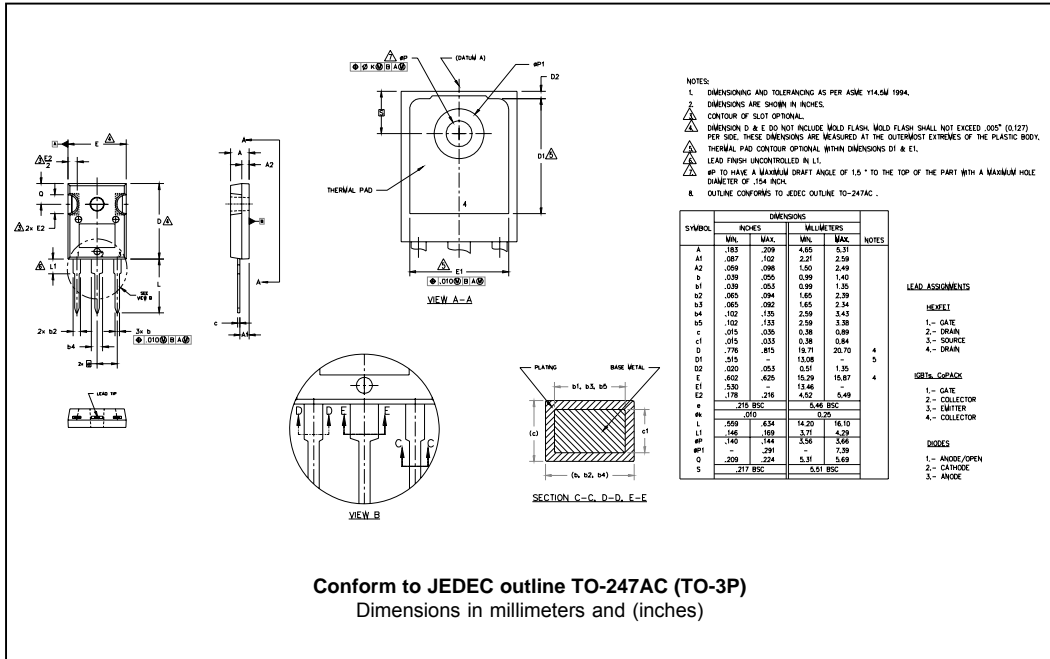
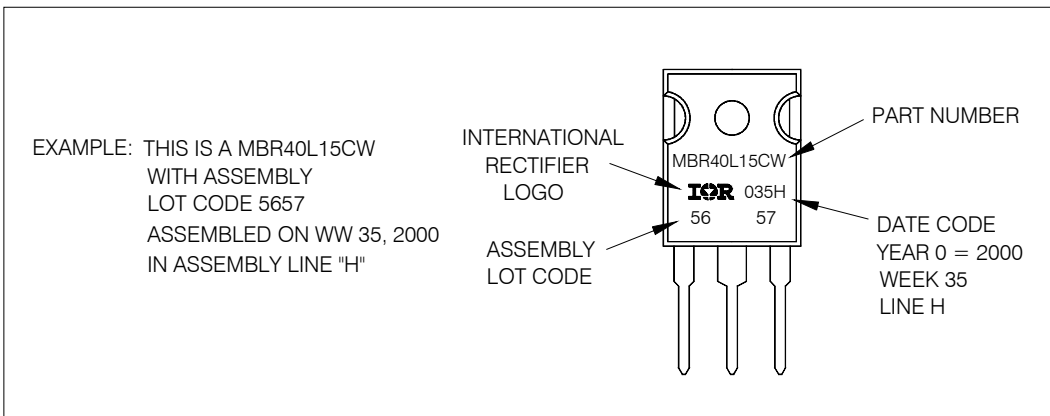

Fig. 8 - Unclamped Inductive Test Circuit

Outline Table



Marking Information



Ordering Information Table

Device Code						
<b>MBR</b>	<b>40</b>	<b>L</b>	<b>15</b>	<b>CW</b>	<b>-</b>	
①	②	③	④	⑤	⑥	
<b>1</b>	-	Schottky MBR Series				
<b>2</b>	-	Current Rating (40 = 40A)				
<b>3</b>	-	L = Low Forward Voltage				
<b>4</b>	-	Voltage Rating (15 = 15V)				
<b>5</b>	-	Circuit Configuration : Center Tap TO-247				
<b>6</b>	-	<ul style="list-style-type: none"> <li>• none = Standard Production</li> <li>• PbF = Lead-Free</li> </ul>				
Tube Standard Pack Quantity : 25 pieces						

Data and specifications subject to change without notice.  
This product has been designed and qualified for Industrial Level.  
Qualification Standards can be found on IR's Web site.