

# MBR20S100CT

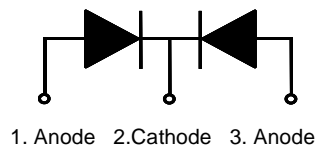
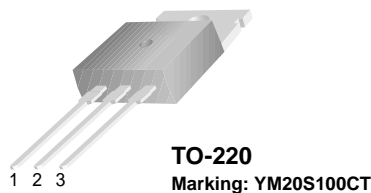
## Schottky Barrier Rectifier

### Features

- Low forward voltage drop
- High frequency properties and switching speed
- Guard ring for over-voltage protection

### Applications

- Switched mode power supply
- Freewheeling diodes



### Absolute Maximum Ratings T<sub>a</sub> = 25°C unless otherwise noted

Symbol	Parameter	Value	Units
V <sub>RRM</sub>	Maximum Repetitive Reverse Voltage	100	V
V <sub>R</sub>	Maximum DC Reverse Voltage	100	V
I <sub>F(AV)</sub>	Average Rectified Forward Current @T <sub>C</sub> = 135°C	20	A
I <sub>FSM</sub>	Non-Repetitive Peak Surge Current (per diode) 60Hz Single Half-Sine Wave	200	A
T <sub>J</sub> , T <sub>STG</sub>	Operating Junction and Storage Temperature	-65 to +150	°C

### Thermal Characteristics

Symbol	Parameter	Value	Units
R <sub>θJC</sub>	Maximum Thermal Resistance, Junction to Case (per diode)	1.54	°C/W

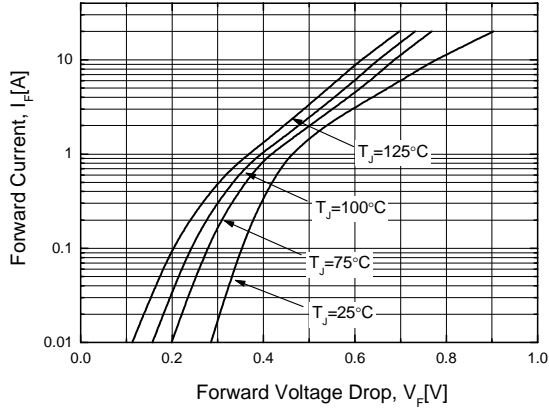
### Electrical Characteristics T<sub>C</sub> = 25°C unless otherwise noted

Symbol	Parameter	Value	Units	
V <sub>FM</sub> *	Maximum Instantaneous Forward Voltage I <sub>F</sub> = 10A I <sub>F</sub> = 10A I <sub>F</sub> = 20A I <sub>F</sub> = 20A	T <sub>C</sub> = 25°C	-	V
		T <sub>C</sub> = 125°C	0.70	V
		T <sub>C</sub> = 25°C	0.95	V
		T <sub>C</sub> = 125°C	0.85	V
I <sub>RM</sub> *	Maximum Instantaneous Reverse Current @ rated V <sub>R</sub>	T <sub>C</sub> = 25°C	0.1	mA
		T <sub>C</sub> = 125°C	20	mA

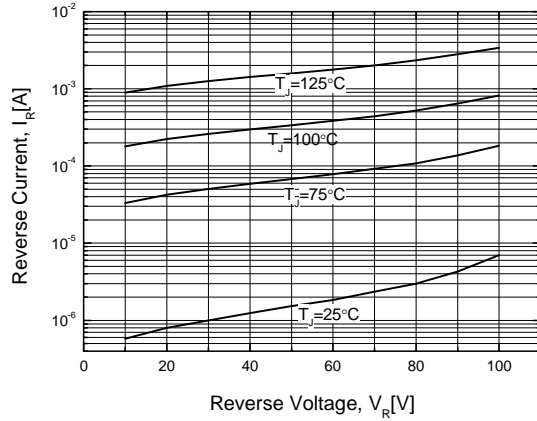
\* Pulse Test: Width = 300μs, Duty Cycle = 2%

## Typical Performance Characteristics

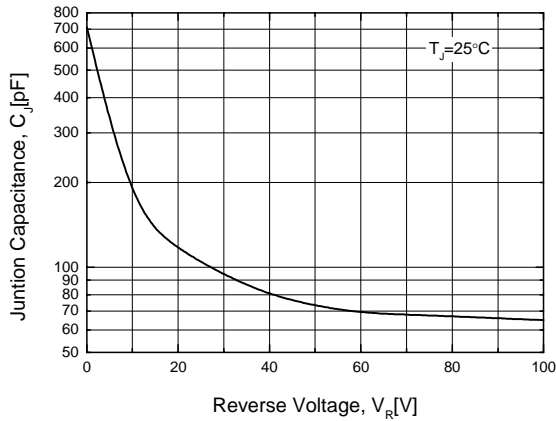
**Figure 1. Typical Forward Voltage Characteristics (per diode)**



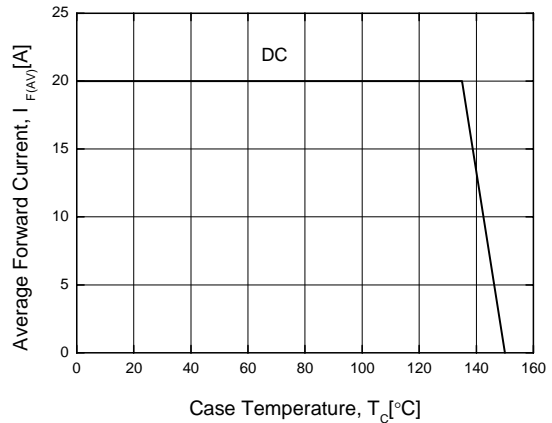
**Figure 2. Typical Reverse Current vs. Reverse Voltage (per diode)**



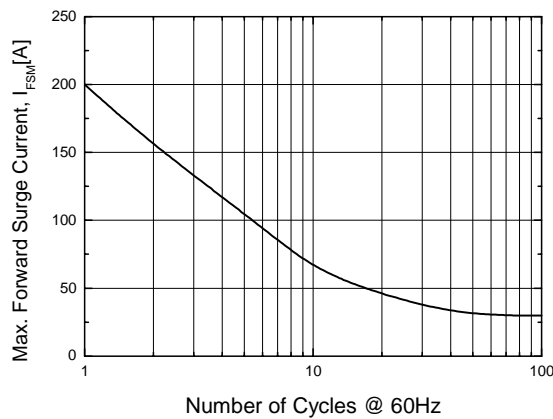
**Figure 3. Typical Junction Capacitance (per diode)**



**Figure 4. Forward Current Derating Curve**

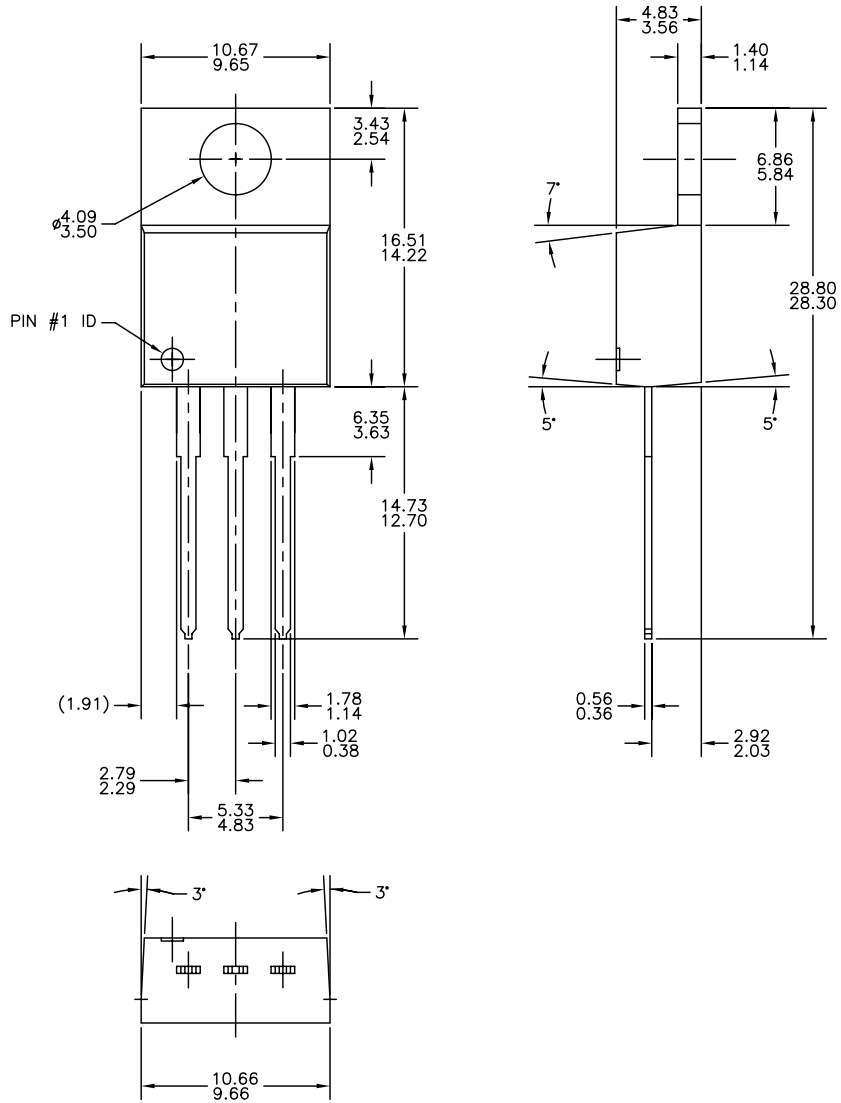


**Figure 5. Non-Repetitive Surge Current (per diode)**



Mechanical Dimensions

TO-220



- NOTES: UNLESS OTHERWISE SPECIFIED
- A) STANDARD LEAD FINISH: 200 MICRINCHES / 5.08 MICROMETERS MIN. LEAD/TIN 15/85 ON COPPER.
  - B) REFERENCE JEDEC, TO-220, ISSUE J, VARIATION AB, DATED MARCH 24, 1987.
  - C) ALL DIMENSIONS ARE IN MILLIMETERS.
  - D) DIMENSIONING AND TOLERANCING PER ANSI Y14.5 - 1973

Dimensions in Millimeters

## TRADEMARKS

The following are registered and unregistered trademarks Fairchild Semiconductor owns or is authorized to use and is not intended to be an exhaustive list of all such trademarks.

ACE <sup>x</sup> ™	FAST <sup>®</sup>	ISOPLANAR™	PowerSaver™	SuperSOT™-8
ActiveArray™	FASTr™	LittleFET™	PowerTrench <sup>®</sup>	SyncFET™
Bottomless™	FPS™	MICROCOUPLER™	QFET <sup>®</sup>	TinyLogic <sup>®</sup>
Build it Now™	FRFET™	MicroFET™	QS™	TINYOPTO™
CoolFET™	GlobalOptoisolator™	MicroPak™	QT Optoelectronics™	TruTranslation™
CROSSVOLT™	GTO™	MICROWIRE™	Quiet Series™	UHC™
DOME™	HiSeC™	MSX™	RapidConfigure™	UltraFET <sup>®</sup>
EcoSPARK™	I <sup>2</sup> C™	MSXPro™	RapidConnect™	UniFET™
E <sup>2</sup> CMOST™	i-Lo™	OCX™	μSerDes™	VCX™
EnSigna™	ImpliedDisconnect™	OCXPro™	SILENT SWITCHER <sup>®</sup>	Wire™
FACT™	IntelliMAX™	OPTOLOGIC <sup>®</sup>	SMART START™	
FACT Quiet Series™		OPTOPLANAR™	SPM™	
Across the board. Around the world.™		PACMAN™	Stealth™	
The Power Franchise <sup>®</sup>		POP™	SuperFET™	
Programmable Active Droop™		Power247™	SuperSOT™-3	
		PowerEdge™	SuperSOT™-6	

## DISCLAIMER

FAIRCHILD SEMICONDUCTOR RESERVES THE RIGHT TO MAKE CHANGES WITHOUT FURTHER NOTICE TO ANY PRODUCTS HEREIN TO IMPROVE RELIABILITY, FUNCTION OR DESIGN. FAIRCHILD DOES NOT ASSUME ANY LIABILITY ARISING OUT OF THE APPLICATION OR USE OF ANY PRODUCT OR CIRCUIT DESCRIBED HEREIN; NEITHER DOES IT CONVEY ANY LICENSE UNDER ITS PATENT RIGHTS, NOR THE RIGHTS OF OTHERS.

## LIFE SUPPORT POLICY

FAIRCHILD'S PRODUCTS ARE NOT AUTHORIZED FOR USE AS CRITICAL COMPONENTS IN LIFE SUPPORT DEVICES OR SYSTEMS WITHOUT THE EXPRESS WRITTEN APPROVAL OF FAIRCHILD SEMICONDUCTOR CORPORATION.

As used herein:

1. Life support devices or systems are devices or systems which, (a) are intended for surgical implant into the body, or (b) support or sustain life, or (c) whose failure to perform when properly used in accordance with instructions for use provided in the labeling, can be reasonably expected to result in significant injury to the user.
2. A critical component is any component of a life support device or system whose failure to perform can be reasonably expected to cause the failure of the life support device or system, or to affect its safety or effectiveness.

## PRODUCT STATUS DEFINITIONS

### Definition of Terms

Datasheet Identification	Product Status	Definition
Advance Information	Formative or In Design	This datasheet contains the design specifications for product development. Specifications may change in any manner without notice.
Preliminary	First Production	This datasheet contains preliminary data, and supplementary data will be published at a later date. Fairchild Semiconductor reserves the right to make changes at any time without notice in order to improve design.
No Identification Needed	Full Production	This datasheet contains final specifications. Fairchild Semiconductor reserves the right to make changes at any time without notice in order to improve design.
Obsolete	Not In Production	This datasheet contains specifications on a product that has been discontinued by Fairchild semiconductor. The datasheet is printed for reference information only.

Rev. I16