



Low-Voltage 3.5Ω, SPDT, CMOS Analog Switches

MAX4729/MAX4730

General Description

The MAX4729/MAX4730 single-pole/double-throw (SPDT) switches operate from a single supply ranging from +1.8V to +5.5V. These switches provide low 3.5Ω on-resistance (RON), as well as 0.45Ω RON flatness with a +2.7V supply. These devices typically consume only 1nA of supply current, making them ideal for use in low-power, portable applications. The MAX4729/MAX4730 feature low-leakage currents over the extended temperature range, TTL/CMOS-compatible digital logic, and excellent AC characteristics.

The MAX4729/MAX4730 are available in small 6-pin SC70 and 6-pin μDFN packages. The MAX4729/MAX4730 are offered in three pinout configurations to ease design. The MAX4729/MAX4730 are specified over the extended -40°C to +85°C temperature range.

Features

- ◆ Low 3.5Ω RON (+2.7V Supply)
- ◆ 0.45Ω RON Flatness (+2.7V Supply)
- ◆ 0.05Ω RON Match Between Channels (+2.7V Supply)
- ◆ Tiny SC70 and μDFN Packages
- ◆ -3dB Bandwidth: 300MHz
- ◆ Low On-Capacitance: 19.5pF
- ◆ 0.036% Total Harmonic Distortion
- ◆ Low Supply Current: 1nA
- ◆ +1.8V to +5.5V Single-Supply Operation

Applications

- Battery-Operated Equipment
- Audio and Video-Signal Routing
- Low-Voltage Data-Acquisition Systems
- Sample-and-Hold Circuits
- Communications Circuits
- Relay Replacement

Ordering Information

PART	TEMP RANGE	PIN-PACKAGE	TOP MARK
MAX4729EXT-T	-40°C to +85°C	6 SC70-6	ABU
MAX4729ELT-T*	-40°C to +85°C	6 μDFN-6	—
MAX4730EXT-T	-40°C to +85°C	6 SC70-6	ABV
MAX4730ELT-T*	-40°C to +85°C	6 μDFN-6	—

*Future product—contact factory for availability.

Pin Configurations/Functional Diagrams/Truth Table

TOP VIEW

MAX4729
SC70

MAX4729
μDFN

MAX4730
SC70
μDFN

MAX4729/ MAX4730		
IN	NC	NO
0	ON	OFF
1	OFF	ON

SWITCHES SHOWN FOR LOGIC 0 INPUT.

Low-Voltage 3.5Ω, SPDT, CMOS Analog Switches

ABSOLUTE MAXIMUM RATINGS

(All voltages referenced to ground)

V+, IN	-0.3V to +6V
COM, NO, NC (Note 1)	-0.3V to (V+ +0.3V)
Continuous Current (IN, V+, GND)	±30mA
Continuous Current (COM, NO, NC)	±80mA
Peak Current COM, NO, NC (Pulsed at 1ms, 10% Duty Cycle)	±150mA

Continuous Power Dissipation (T_A = +70°C)

6-Pin μDFN (derate 2.1mW/°C above +70°C)	168mW
6-Pin SC70 (derate 3.1mW/°C above +70°C)	245mW
Operating Temperature Range	-40°C to +85°C
Maximum Junction Temperature	+150°C
Storage Temperature Range	-65°C to +150°C
Lead Temperature (soldering, 10s)	+300°C

Note 1: Signals on NO, NC, or COM exceeding V+ or GND are clamped by internal diodes. Signals on IN exceeding GND are clamped by an internal diode. Limit forward-diode current to maximum current rating.

Stresses beyond those listed under "Absolute Maximum Ratings" may cause permanent damage to the device. These are stress ratings only, and functional operation of the device at these or any other conditions beyond those indicated in the operational sections of the specifications is not implied. Exposure to absolute maximum rating conditions for extended periods may affect device reliability.

ELECTRICAL CHARACTERISTICS

(V+ = +2.7V to +3.6V, V_{IH} = +2.0V, V_{IL} = +0.4V, T_A = T_{MIN} to T_{MAX}, unless otherwise noted. Typical values are at T_A = +25°C.) (Note 2)

PARAMETER	SYMBOL	CONDITIONS	T _A	MIN	TYP	MAX	UNITS
ANALOG SWITCH							
Analog Signal Range	V _{COM} , V _{NO} , V _{NC}			0		V+	V
On-Resistance (Note 6)	R _{ON}	V+ = 2.7V, I _{COM} = 10mA, V _{NO} or V _{NC} = 0V to V+	+25°C T _{MIN} to T _{MAX}		3.5	5.5 5.7	Ω
On-Resistance Match Between Channels (Notes 3, 6)	ΔR _{ON}	V+ = 2.7V, I _{COM} = 10mA, V _{NO} or V _{NC} = 0.7V, 1.2V, 2V (MAX4729) V+ = 2.7V, I _{COM} = 10mA, V _{NO} or V _{NC} = 0.7V, 1.2V, 2V (MAX4730)	+25°C T _{MIN} to T _{MAX} +25°C T _{MIN} to T _{MAX}		0.05 0.2 0.2	0.15 0.2 0.34	Ω
On-Resistance Flatness (Note 4)	R _{FLAT(ON)}	V+ = 2.7V, I _{COM} = 10mA, V _{NO} or V _{NC} = 0.7V, 1.2V, 2V (MAX4729) V+ = 2.7V, I _{COM} = 10mA, V _{NO} or V _{NC} = 0.7V, 1.2V, 2V (MAX4730)	+25°C T _{MIN} to T _{MAX} +25°C T _{MIN} to T _{MAX}		0.8 0.45	1.5 0.95 1.3	Ω
NO, NC Off-Leakage Current	I _{NO} (OFF), I _{NC} (OFF)	V+ = 3.3V, V _{COM} = 1V, 3V, V _{NO} or V _{NC} = 3V, 1V	+25°C T _{MIN} to T _{MAX}	-2 -3	+0.01	+2 +3	nA
COM On-Leakage Current	I _{COM} (ON)	V+ = 3.3V, V _{COM} = 1V or 3V, V _{NO} or V _{NC} = 1V, 3V, or float	+25°C T _{MIN} to T _{MAX}	-3 -4	+0.01	+3 +4	nA
DIGITAL INPUTS							
Input Logic High	V _{IH}		T _{MIN} to T _{MAX}	2.0			V
Input Logic Low	V _{IL}		T _{MIN} to T _{MAX}			0.4	V
Input Leakage Current	I _{IN}	V _{IN} = 0V or 3.6V	T _{MIN} to T _{MAX}	-1	+0.005	+1	μA

Low-Voltage 3.5Ω, SPDT, CMOS Analog Switches

MAX4729/MAX4730

ELECTRICAL CHARACTERISTICS (continued)

(V+ = +2.7V to +3.6V, V_{IH} = +2.0V, V_{IL} = +0.4V, T_A = T_{MIN} to T_{MAX}, unless otherwise noted. Typical values are at T_A = +25°C.) (Note 2)

PARAMETER	SYMBOL	CONDITIONS	T _A	MIN	TYP	MAX	UNITS
DYNAMIC							
Turn-On Time (Note 5)	t _{ON}	V _{NO} , V _{NC} = 2V, R _L = 300Ω, C _L = 35pF, Figure 1	+25°C	18	45	45	ns
			T _{MIN} to T _{MAX}				
Turn-Off Time (Note 5)	t _{OFF}	V _{NO} , V _{NC} = 2V, R _L = 300Ω, C _L = 35pF, Figure 1	+25°C	10	26	26	ns
			T _{MIN} to T _{MAX}				
Break-Before-Make (Note 5)		V _{NO} , V _{NC} = 2V, R _L = 300Ω, C _L = 35pF, Figure 1	+25°C	5		1	ns
			T _{MIN} to T _{MAX}				
Charge Injection	Q	V _{GEN} = 0V, R _{GEN} = 0, C _L = 1.0nF, Figure 3		3			pC
NO, NC Off-Capacitance	C _{NO(OFF)} , C _{NC(OFF)}	f = 1MHz, Figure 4		6.5			pF
Switch On-Capacitance	C _{ON}	f = 1MHz, Figure 4		19.5			pF
Off-Isolation (Note 7)	V _{ISO}	V _{NO} = V _{NC} = 1V _{RMS} , R _L = 50Ω, C _L = 5pF, Figure 2	f = 1MHz	-67			dB
			f = 10MHz	-45			
On-Channel Bandwidth -3dB	BW	Signal = 0dBm, 50Ω in and out, Figure 2		300			MHz
Crosstalk (Note 8)	V _{CT}	NO or NC = 1V _{RMS} , C _L = 5pF, R _L = 50Ω, Figure 2	f = 1MHz	-67			dB
			f = 10MHz	-52			
Total Harmonic Distortion	THD	R _L = 600Ω, V _{NC} or V _{NO} = 2V _{P-P} , f = 20Hz to 20kHz	+25°C	0.035			%
POWER SUPPLY							
Power-Supply Range	V+			1.8		5.5	V
Positive Supply Current	I+	V+ = 5.5V, V _{IN} = 0V or 5.5V	+25°C	0.001		1	μA
			T _{MIN} to T _{MAX}				

Note 2: SC70 and μDFN parts are 100% tested at T_A = +25°C. Limits across the full-temperature range are guaranteed by design and correlation.

Note 3: ΔR_{ON} = R_{ON(MAX)} - R_{ON(MIN)}.

Note 4: R_{ON} flatness is defined as the difference between the maximum and minimum value of on-resistance as measured over the specified analog signal ranges.

Note 5: Guaranteed by design.

Note 6: μDFN is guaranteed by design.

Note 7: Off-Isolation = 20log₁₀ (V_O / V_I), where V_O is V_{COM} and V_I is either V_{NC} or V_{NO} from the network analyzer.

Note 8: Crosstalk is measured between the two switches.

Low-Voltage 3.5Ω, SPDT, CMOS Analog Switches

Typical Operating Characteristics

(T_A = +25°C, unless otherwise noted.)

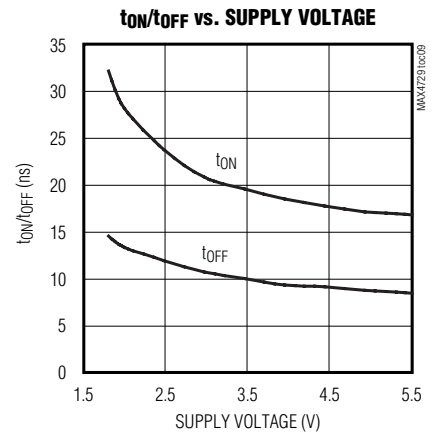
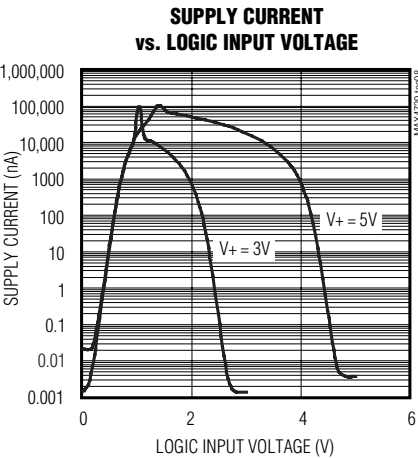
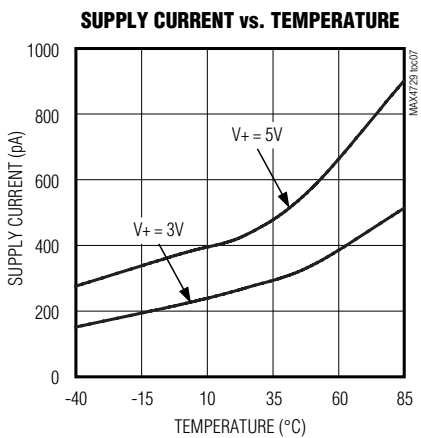
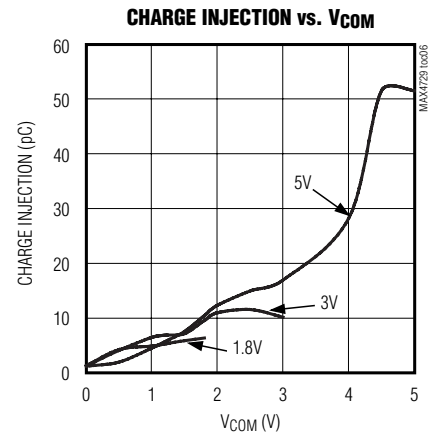
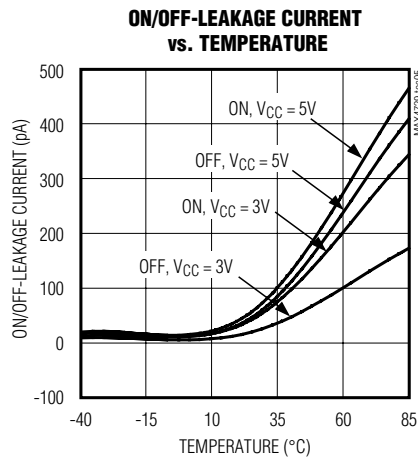
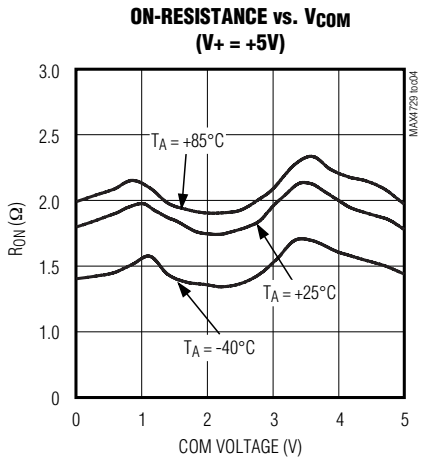
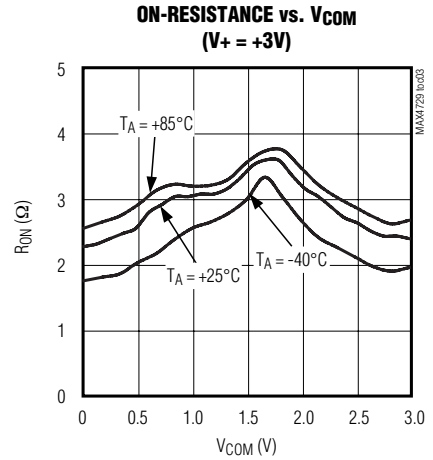
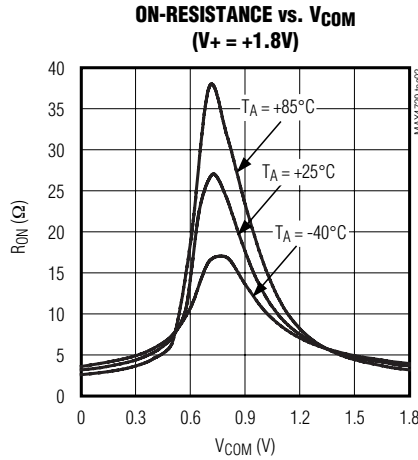
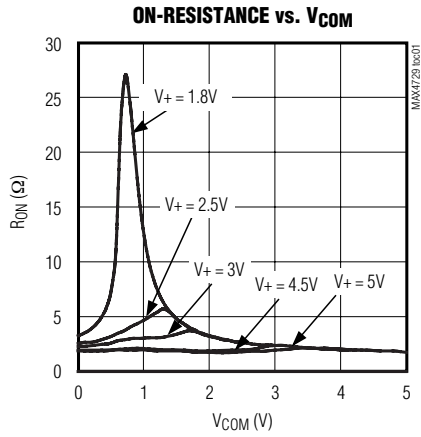

Low-Voltage 3.5Ω, SPDT, CMOS Analog Switches

Typical Operating Characteristics (continued)

(T_A = +25°C, unless otherwise noted.)

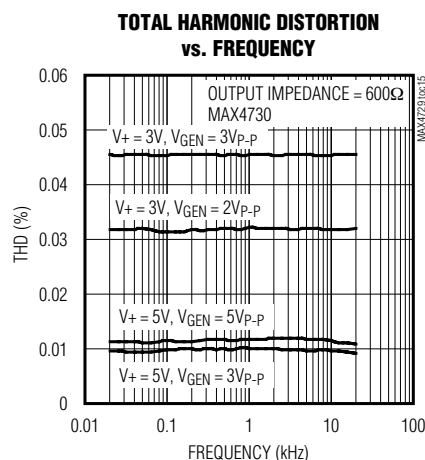
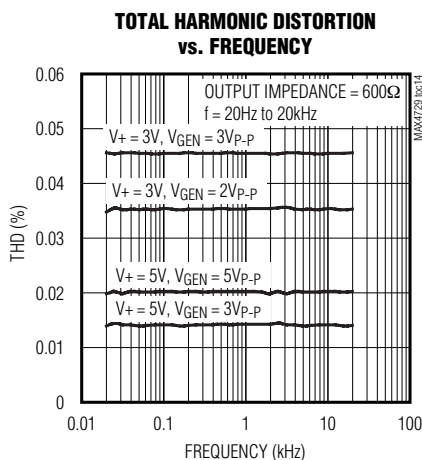
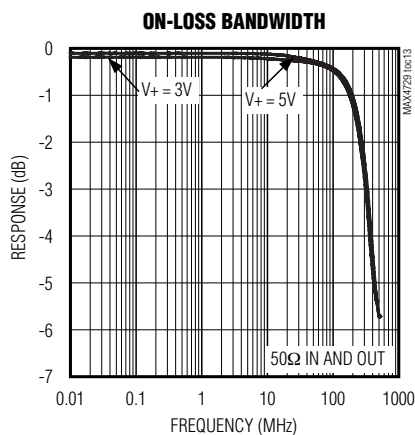
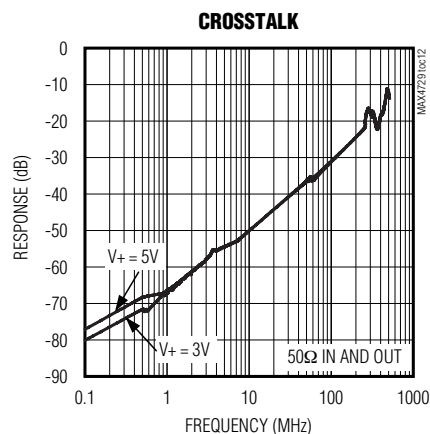
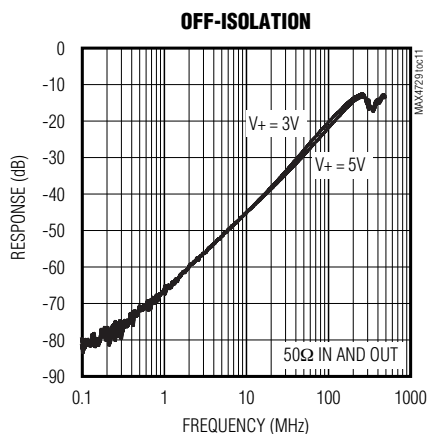
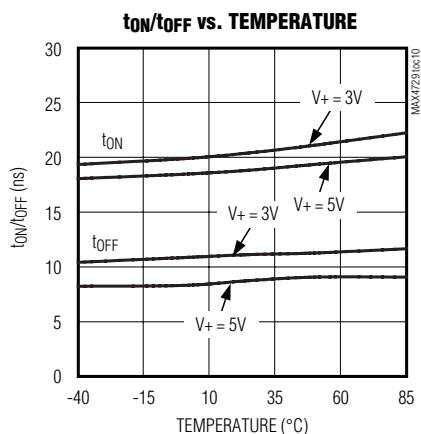

MAX4729/MAX4730

Pin Description

PIN			NAME	FUNCTION
MAX4729	MAX4730			
SC70	μDFN	SC70/μDFN		
1	3	6	IN	Logic-Control Input
2	2	5	V+	Positive Supply Voltage
3	4	2	GND	Ground
4	6	3	NC	Analog Switch Normally Closed Terminal
5	5	4	COM	Analog Switch Common Terminal
6	1	1	NO	Analog Switch Normally Open Terminal

Low-Voltage 3.5Ω, SPDT, CMOS Analog Switches

Detailed Description

The MAX4729/MAX4730 single-pole/double-throw (SPDT) switches operate from a single supply ranging from +1.8V to +5.5V. These switches provide low 3.5Ω on-resistance (R_{ON}), as well as 0.45Ω R_{ON} flatness with a 2.7V supply. These devices typically consume only 1nA of supply current, making them suitable for use in low-power, portable applications. The MAX4729/MAX4730 feature low-leakage currents over the entire temperature range, TTL/CMOS-compatible digital logic, and excellent AC characteristics.

Applications Information

Digital Control Inputs

The MAX4729/MAX4730 logic inputs accept up to +5.5V, regardless of supply voltage. For example, with a +3.3V

supply, IN can be driven low to GND and high to +5.5V, allowing for mixing of logic levels in a system. With a 2.7V to 3.6V power-supply voltage range, the logic thresholds are set so $V_{IL} = 0.4V$ (max) and $V_{IH} = 2V$ (min).

Power-Supply Sequencing and Overtolerance Protection

Caution: Do not exceed the absolute maximum ratings because stresses beyond the listed ratings can cause permanent damage to the device. Proper power-supply sequencing is recommended for all CMOS devices. Always apply $V+$ before applying analog signals, especially if the analog signal is not current limited.

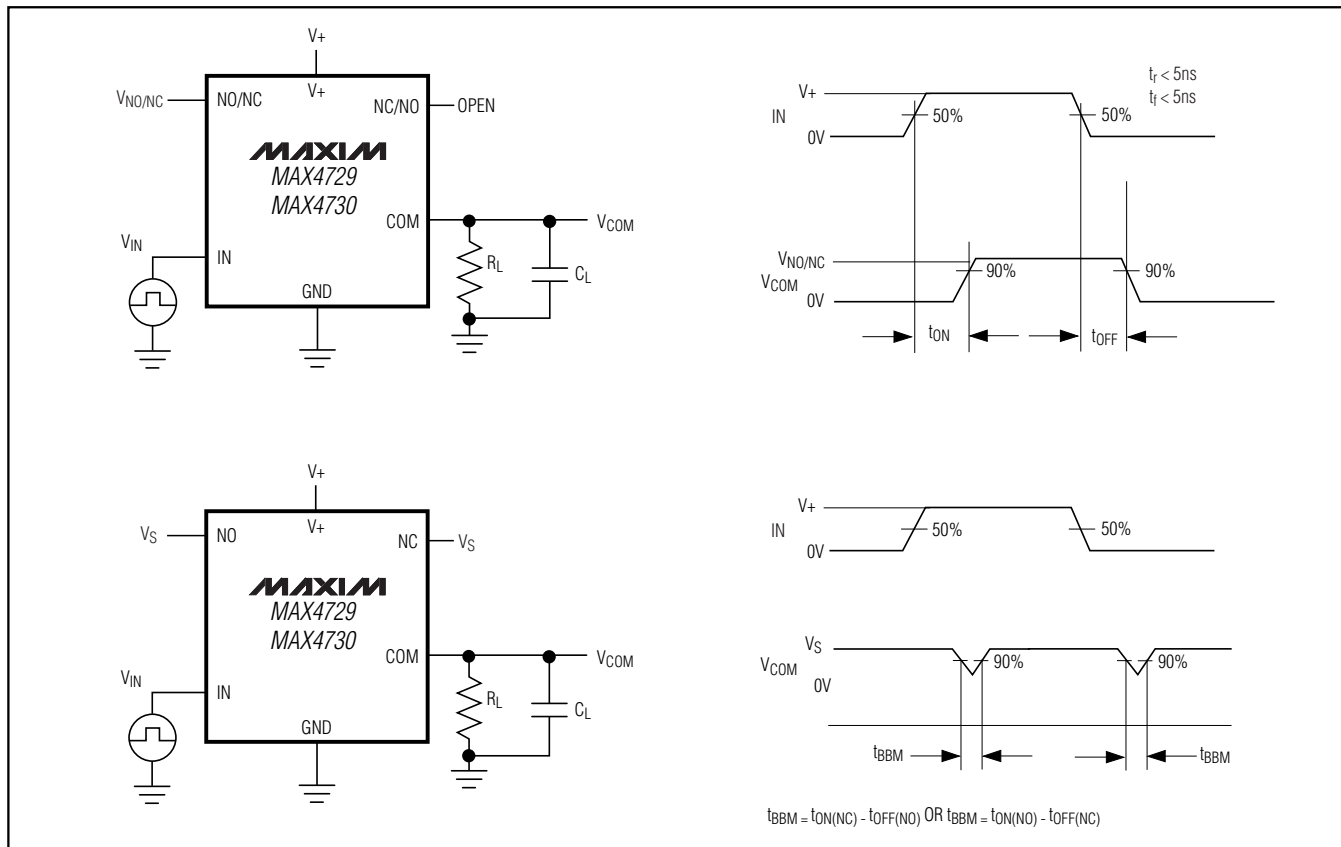
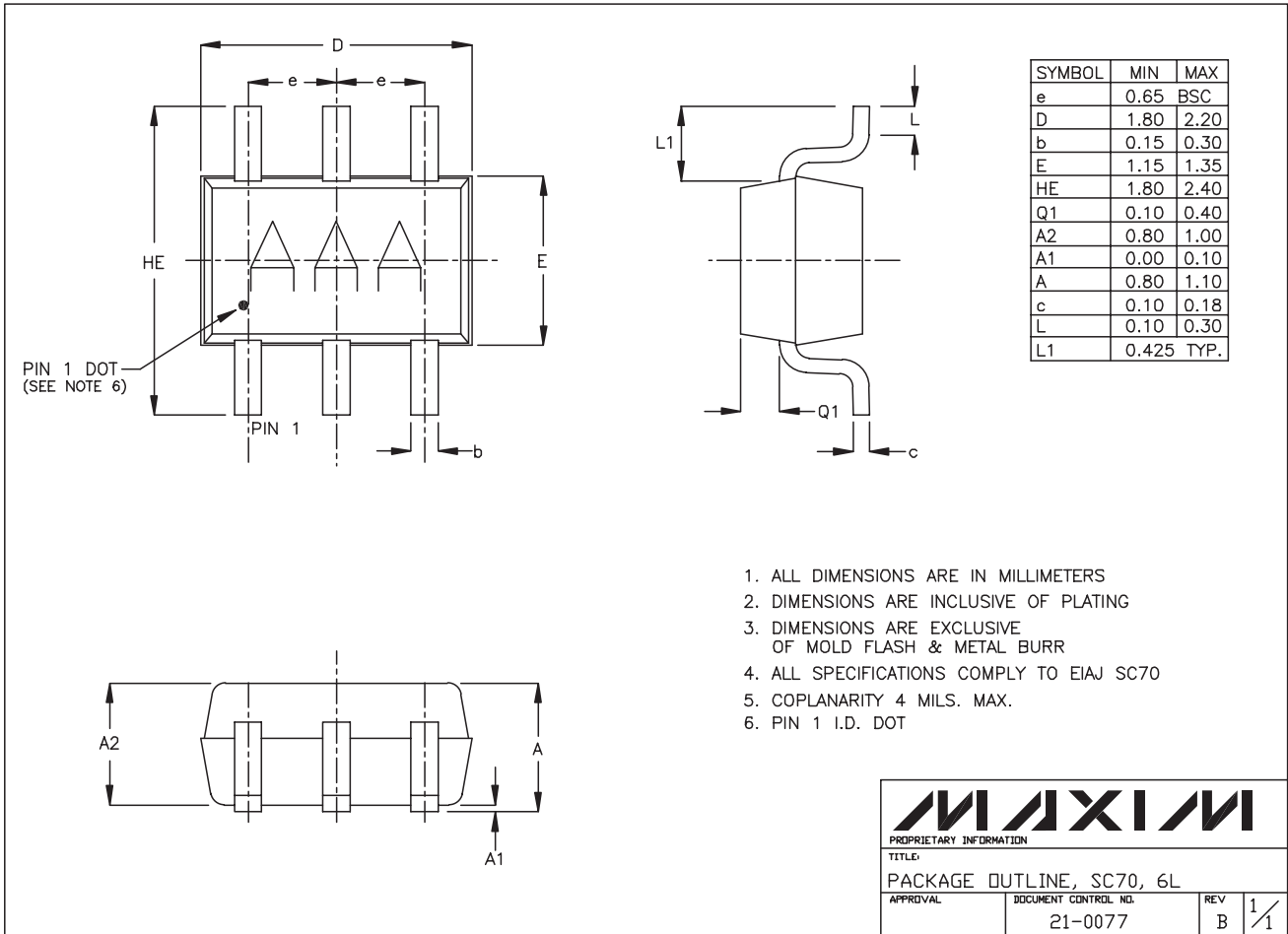

Figure 1. Switching Times

Low-Voltage 3.5Ω, SPDT, CMOS Analog Switches

Package Information

(The package drawing(s) in this data sheet may not reflect the most current specifications. For the latest package outline information, go to www.maxim-ic.com/packages.)



SC70, 6L-EPS

MAXIM

PROPRIETARY INFORMATION

TITLE:
PACKAGE OUTLINE, SC70, 6L

APPROVAL	DOCUMENT CONTROL NO. 21-0077	REV B	1/1
----------	---------------------------------	----------	-----

Low-Voltage 3.5Ω, SPDT, CMOS Analog Switches

Package Information (continued)

(The package drawing(s) in this data sheet may not reflect the most current specifications. For the latest package outline information, go to www.maxim-ic.com/packages.)

MAX4729/MAX4730

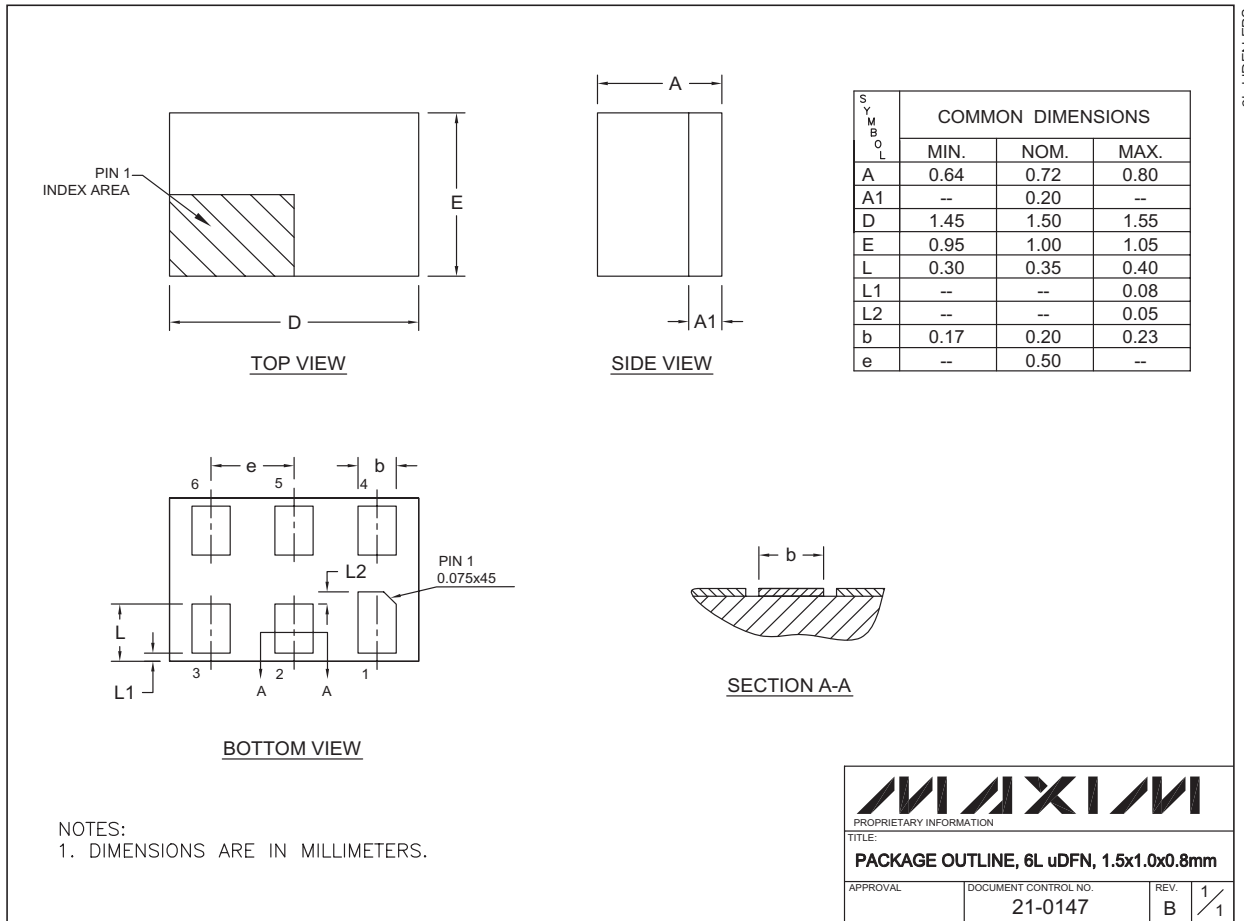

Maxim cannot assume responsibility for use of any circuitry other than circuitry entirely embodied in a Maxim product. No circuit patent licenses are implied. Maxim reserves the right to change the circuitry and specifications without notice at any time.

Maxim Integrated Products, 120 San Gabriel Drive, Sunnyvale, CA 94086 408-737-7600 9