



MAX2335 Evaluation Kit

General Description

The MAX2335 evaluation kit (EV kit) simplifies evaluation of the MAX2335 450MHz, CDMA/OFDM LNA/mixer. This kit allows evaluation of the device's low-noise amplifier (LNA), downconverter, and buffer. Figure 1 shows the MAX2335 EV kit schematic. The EV kit provides 50Ω SMA connectors for all RF and IF input and output signals.

Features

- ◆ Easy Evaluation of the MAX2335
- ◆ +2.9V to +3.3V Single-Supply Operation
- ◆ All Critical Matching Components Included
- ◆ CDMA-Band RF Ports Matched to 450MHz
- ◆ SMA Connectors for All RF and IF Signal Ports
- ◆ Easy Configuration of Operating Modes

Ordering Information

| PART | TEMP RANGE | IC PACKAGE |
|--------------|----------------|-----------------|
| MAX2335EVKIT | -40°C to +85°C | 28 Thin QFN-EP* |

*EP = Exposed paddle.

Component List

| DESIGNATION | QTY | DESCRIPTION |
|--|-----|--|
| C1, C9 | 2 | 0.01μF ±10% capacitors GRM155R71C103K |
| C2, C22, C24, C27 | 4 | 100pF ±5% capacitors TDK C1005C0G1H101J |
| C3–C6, C8, C10, C12, C14, C17, C21, C30, C31, C33 | 0 | Open |
| C7 | 1 | 3.9pF ±5% capacitor EMK105SJ3R9JW-B |
| C11, C18, C19, C20, C26, C28 | 6 | 1000pF ±10% capacitors TDK C1005X7R1H102K |
| C16 | 1 | 6800pF capacitor TDK C1005X7R1E682K |
| C23, C25 | 2 | 6.8pF ±5% capacitors EMK105RH6R8JW-B |
| C29 | 1 | 22μF ±5% capacitor TAJC226K010 |
| J1–J5 | 5 | Open |
| JU1, JU3, JU4, JU5, JU7 | 5 | 1 x 3 headers Sullins PTC36SAAN |
| JU1–JU8, JU10 | 9 | Shunts Sullins STC02SYAN |
| JU2, JU6, JU8, JU10 | 4 | 1 x 2 headers Sullins PTC36SAAN |
| L1 | 1 | 18nH ±5% inductor (0402) TOKO LL1608-FH18NJ |
| L3, L10, L11, L12 | 4 | Open |

| DESIGNATION | QTY | DESCRIPTION |
|-------------------------------|-----|---|
| L5 | 1 | 22nH ±5% inductor (0402) TOKO LL1608-FH22NJ |
| L6 | 1 | 47nH ±5% inductor (0603) Coilcraft CS-47NXJBC |
| L7, L8 | 2 | 270nH ±5% inductors (0805) TOKO LL2012-FHLR27J |
| L9 | 1 | 1nH ±5% inductor (0402) Coilcraft CS-1N0XJBW |
| L13 | 1 | 47nH ±2% inductor (0402) Coilcraft CS-47NXGBW |
| LNAOUT, IFOUT, LNAIN, LOIN | 4 | SMA connectors Johnson 142-0701-801 |
| MIXIN, LOOUT | 2 | SMA connectors Johnson 142-0701-201 |
| R1, R4, R5, R6, R8 | 5 | 1kΩ ±5% resistors (0402) |
| R2, R9, R12, R13 | 4 | Open |
| R3 | 1 | 18.2kΩ ±1% resistor (0402) |
| R7 | 1 | 1kΩ ±1% resistor (0402) |
| R10 | 1 | 24.3kΩ ±1% resistor (0603) |
| R11, R16, L2 | 3 | 0Ω ±5% resistors (0402) |
| R14 | 1 | 20Ω ±1% resistor (0402) |
| R15 | 1 | 475Ω ±1% resistor (0603) |
| T1 | 1 | Balun transformer TOKO B5F 458DB-1011 |
| U1 | 1 | MAX2335ETI 28-pin TQFN-EP |
| VCC, GND | 2 | Test points Digi-Key 5000K-ND |

Evaluates: MAX2335

MAX2335 Evaluation Kit

Component Suppliers

| SUPPLIER | PHONE | FAX | WEBSITE |
|------------|--------------|--------------|-------------------|
| AVX | 803-946-0690 | 803-626-2123 | www.avx-corp.com |
| EF Johnson | 402-474-4800 | 402-474-4858 | www.efjohnson.com |
| Kamaya | 219-489-1533 | 219-489-2261 | www.kamaya.com |
| Murata | 949-852-2001 | 949-852-2002 | www.murata.com |
| TOKO | 708-297-0070 | 708-699-1194 | www.toko.com |

Note: Indicate that you are using the MAX2335 when contacting these suppliers.

Recommended Test Equipment

- Power supply capable of providing 100mA at +2.9V to +3.3V
- Two RF signal generators capable of delivering -70dBm to -10dBm of output power from 450MHz to 1200MHz (HP 8658C or equivalent)
- Network analyzer covering the MAX2335 operating frequency range (HP 8753 or equivalent)
- Spectrum analyzer covering the MAX2335 operating frequency range (HP 8561E or equivalent)
- Ammeter (optional) for measuring supply current
- Noise figure meter (optional) for measuring the noise figure of the LNA and downconverters (HP 8970B or equivalent)

Quick Start

The MAX2335 EV kit is fully assembled and factory tested. Follow the instructions in the *Connections and Setup* section for proper device evaluation.

Connections and Setup

This section provides a step-by-step guide to setting up the MAX2335 EV kit and testing the LNA and downconverters. **Do not turn on the DC power or RF signal generators until all connections are made.**

Low-Noise Amplifier, High-Gain High-Linearity Mode

- 1) Set Mode 0 (JU1), Mode 1 (JU3), and Mode 2 (JU4) on the EV kit to VCC (high). This enables the LNA to operate in the high-gain and high-linearity mode.
- 2) Connect a DC supply preset to +3V (through an ammeter, if desired) to the EV kit's VCC and GND terminals. Do not turn on the supply.
- 3) Perform a full two-port calibration on a network analyzer at a -30dBm power level over a 400MHz to 500MHz frequency range.

- 4) Connect port 1 and port 2 of the network analyzer to LNAIN and LNAOUT, respectively, to measure the gain at 465MHz.
- 5) The network-analyzer display should indicate a typical gain of 16dB at 465MHz after accounting for board losses. The input and output board losses are 0.3dB at the 465MHz band. These losses are to be added to the measurements to obtain the performance of the LNA.

Downconverter, High-Gain High-Linearity Mode

- 1) Turn off the DC supply.
- 2) Remove the network analyzer from the LNA input and output connections. The DC supply connections for testing the downconverter mixer are the same as the LNA section.
- 3) Set the LO/2 jumper (JU5) to VCC to enable the LO divider circuit.
- 4) The mode setting for testing the downconverter mixer is the same as the LNA section.
- 5) Connect an RF signal generator (with output disabled) to the LOIN connector. Set the frequency to 1150MHz and the output power to -7dBm.
- 6) Connect another RF signal generator (with output disabled) to the MIXIN SMA connector. Set the frequency to 465MHz and the output power to -40dBm.
- 7) Connect the spectrum analyzer to the IFOUT SMA connector. Set the spectrum-analyzer center frequency to 110MHz.
- 8) Turn on the DC supply. Enable the LO signal generator and RF input signal generator outputs.
- 9) Measure the peak of the 110MHz IF signal on the spectrum analyzer. Compensate the IF signal conversion gain of the balun and the board losses. The balun loss is approximately 0.3dB and the input and output board losses are 0.1dB each.
- 10) The conversation gain is approximately 13dB after corrections from step 9 are applied.

MAX2335 Evaluation Kit

Evaluates: MAX2335

Checking Noise Figure

Noise figure measurements are sensitive to board and lab setup losses and parasitics. There are many techniques and precautions for measuring a low noise figure. Detailed explanation of these items goes beyond the scope of this document. For more information on how to perform this level of noise figure measurement, refer to the noise figure meter operating manual, as well as to the Hewlett Packard Application Note #57-2, *Noise Figure Measurement Accuracy*.

PC Board Layout Considerations

The MAX2335 EV kit can serve as a board layout guide. Keep PC board trace lengths as short as possible to minimize parasitics. Keep decoupling capacitors close to the device, with a low-inductance connection to the ground plane.

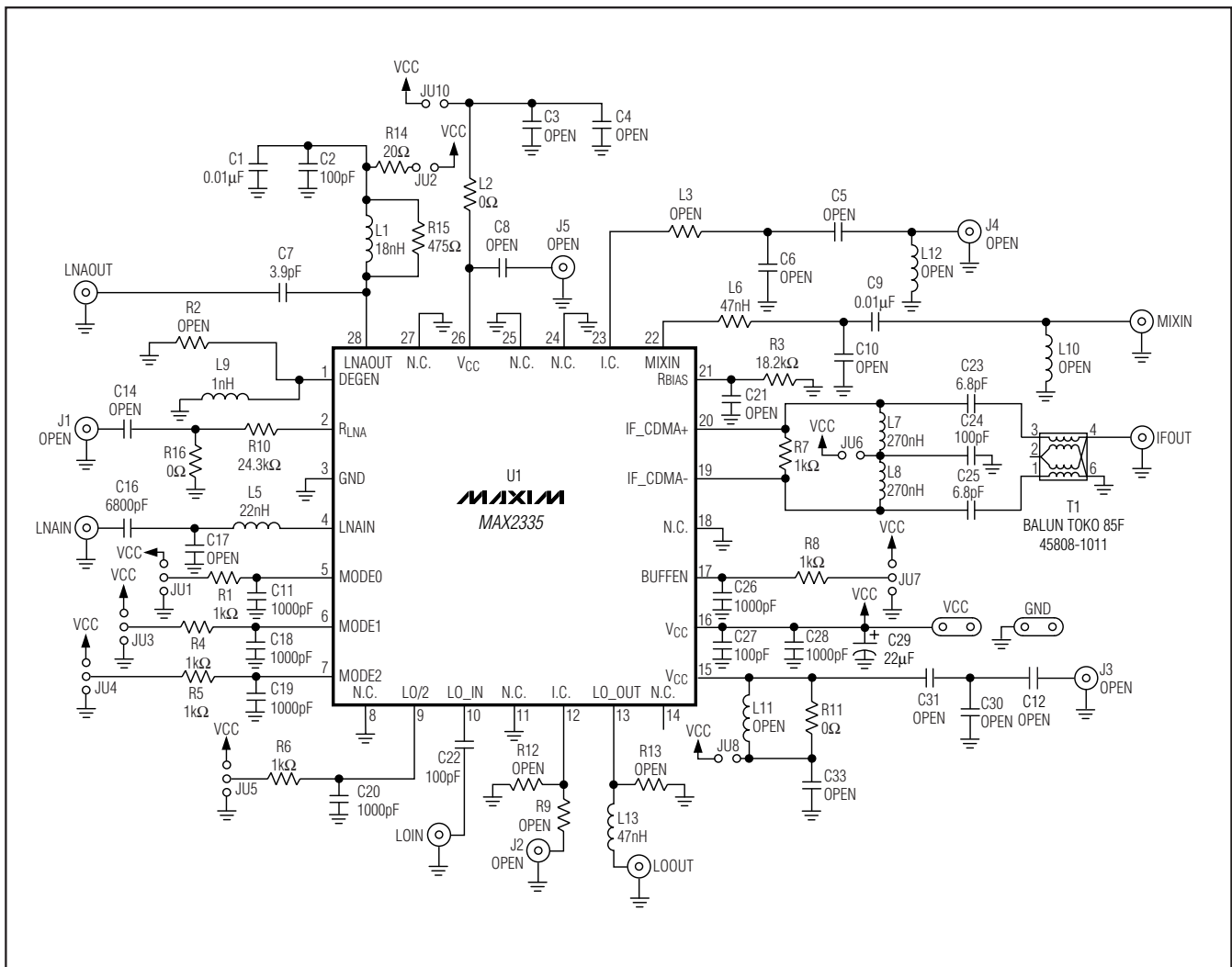

Figure 1. MAX2335 EV Kit Schematic

MAX2335 Evaluation Kit

Evaluates: MAX2335

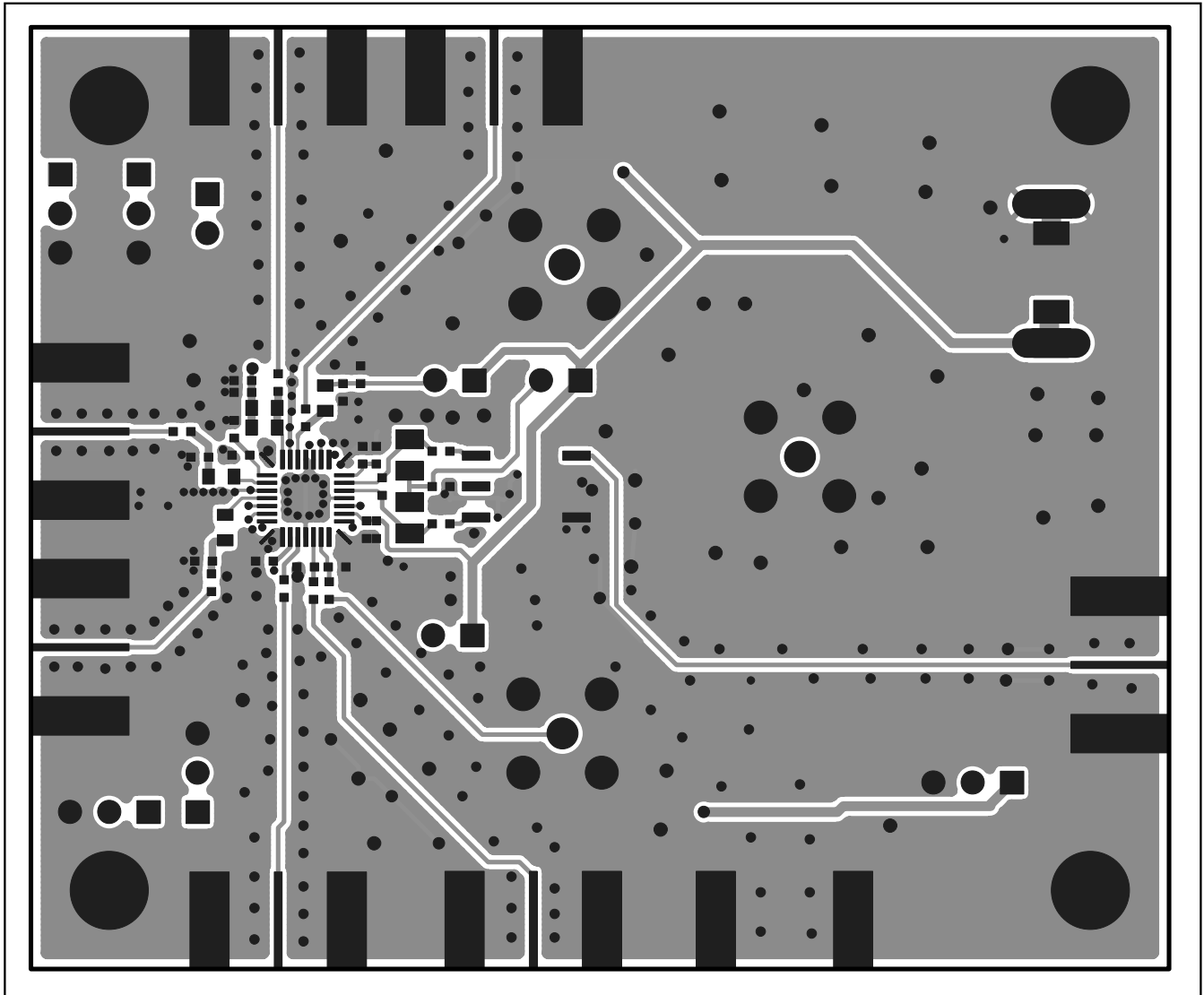

Figure 2. MAX2335 EV Kit PC Board Layout—Front Side

MAX2335 Evaluation Kit

Evaluates: MAX2335

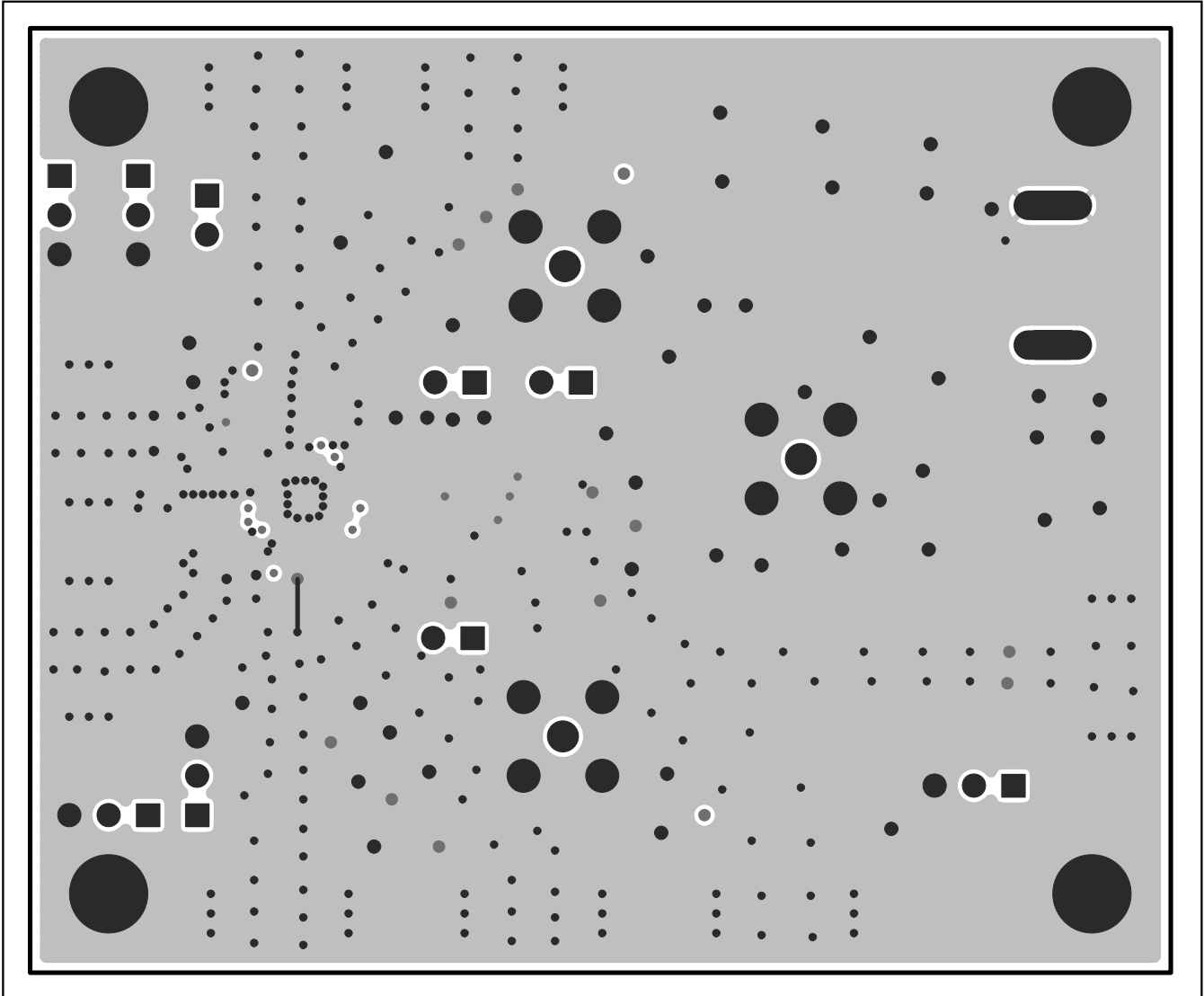

Figure 3. MAX2335 EV Kit PC Board Layout—Ground Layer 2

MAX2335 Evaluation Kit

Evaluates: MAX2335

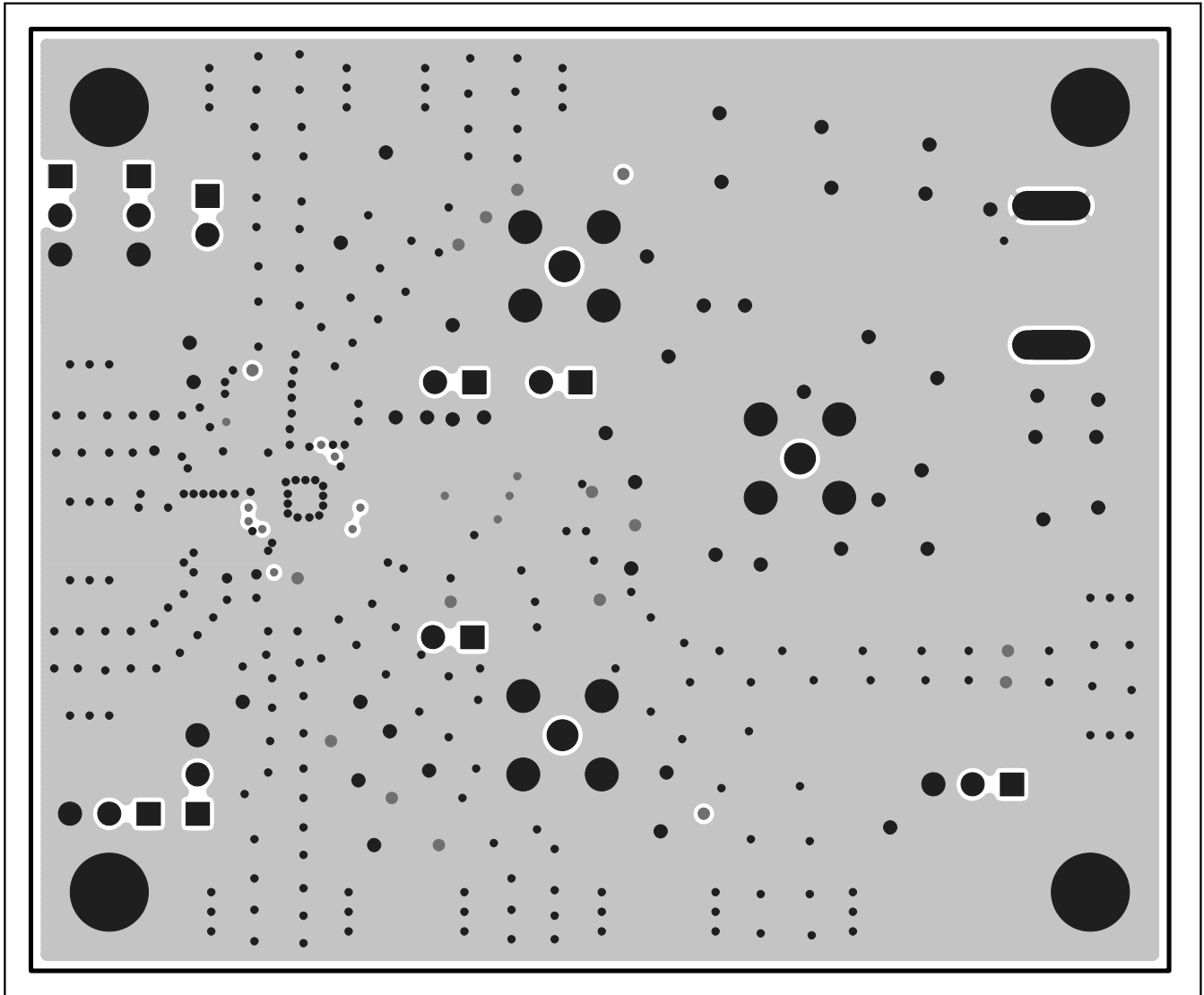

Figure 4. MAX2335 EV Kit PC Board Layout—Ground Layer 3

MAX2335 Evaluation Kit

Evaluates: MAX2335

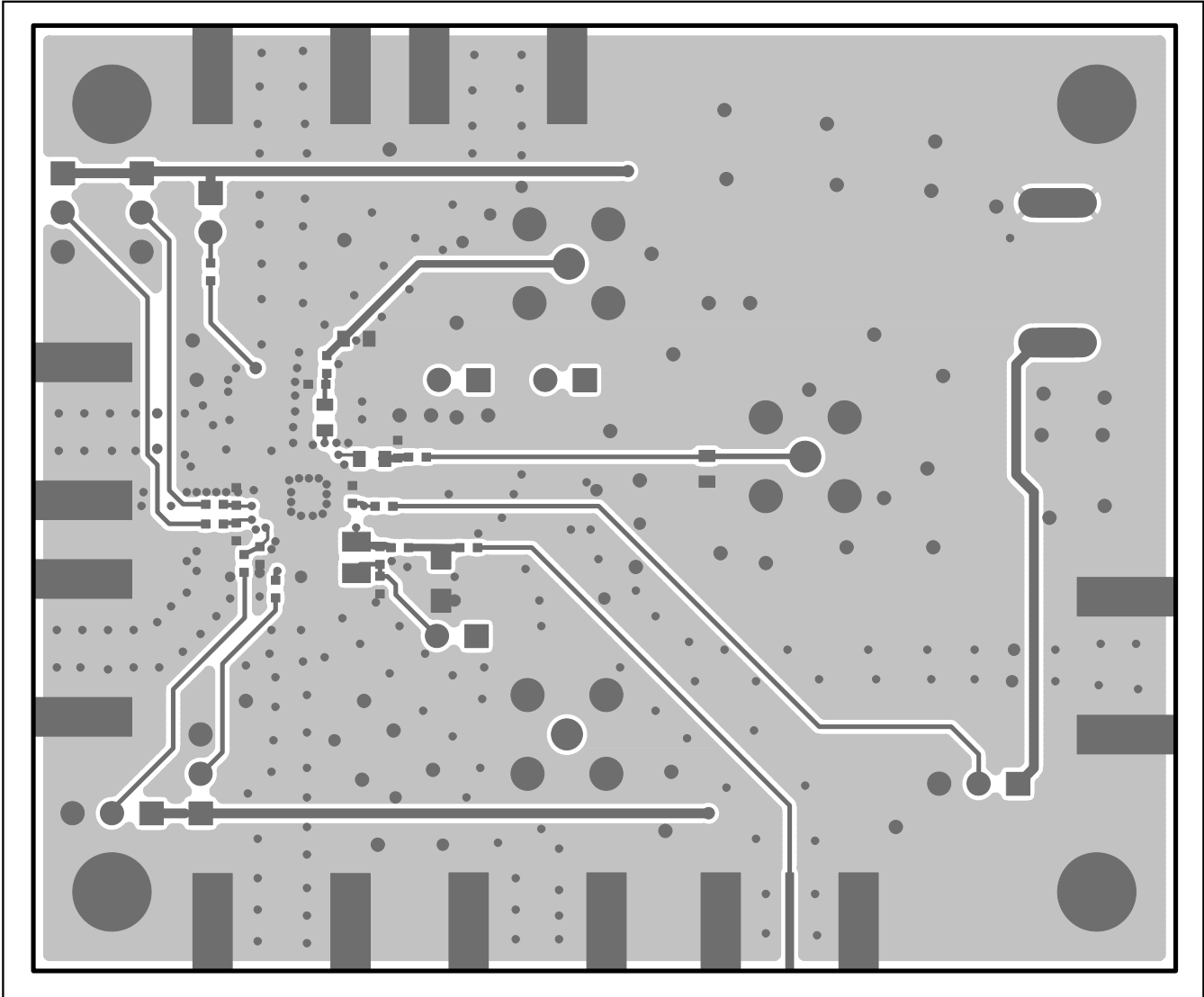

Figure 5. MAX2335 EV Kit PC Board Layout—Back Side

MAX2335 Evaluation Kit

Evaluates: MAX2335

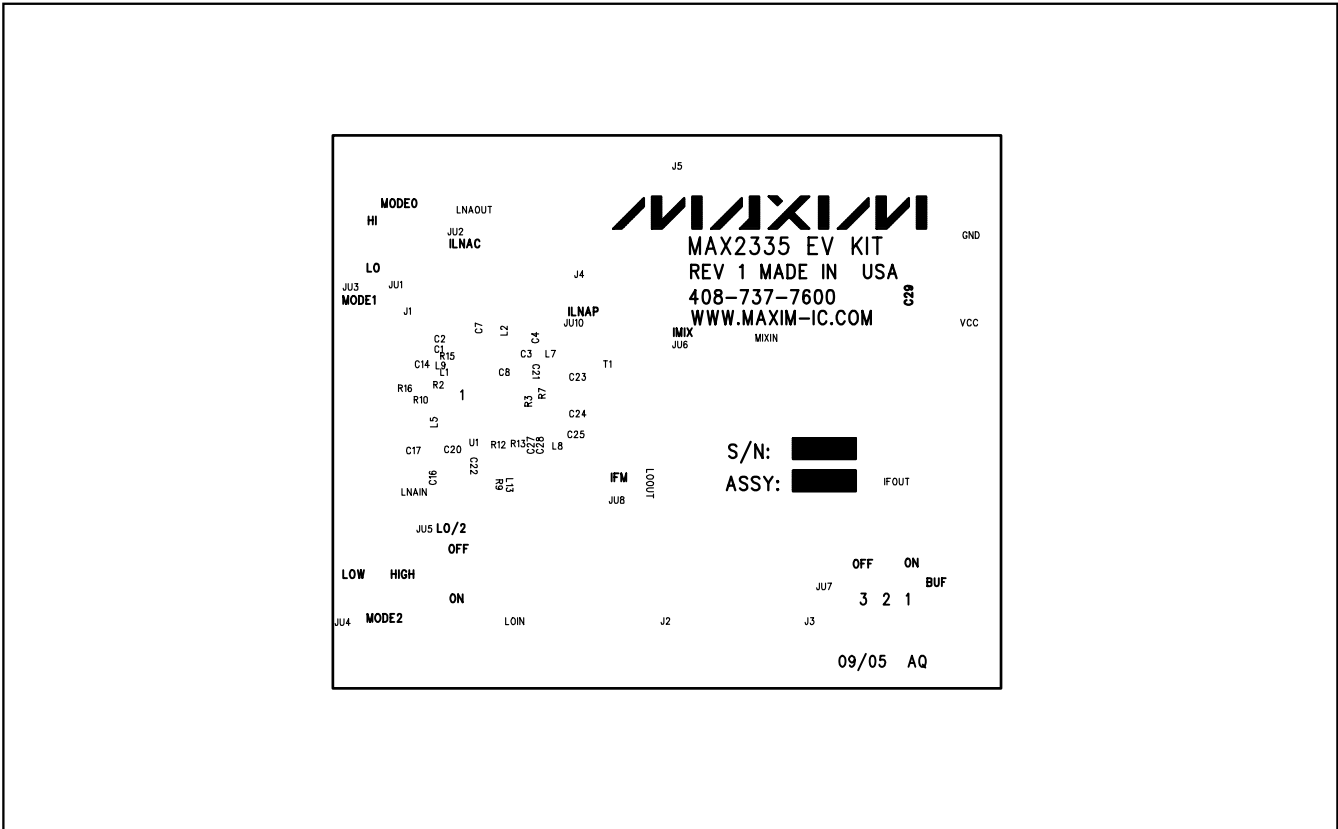

Figure 6. MAX2335 EV Kit Component Placement Guide—Top Silk

MAX2335 Evaluation Kit

Evaluates: MAX2335

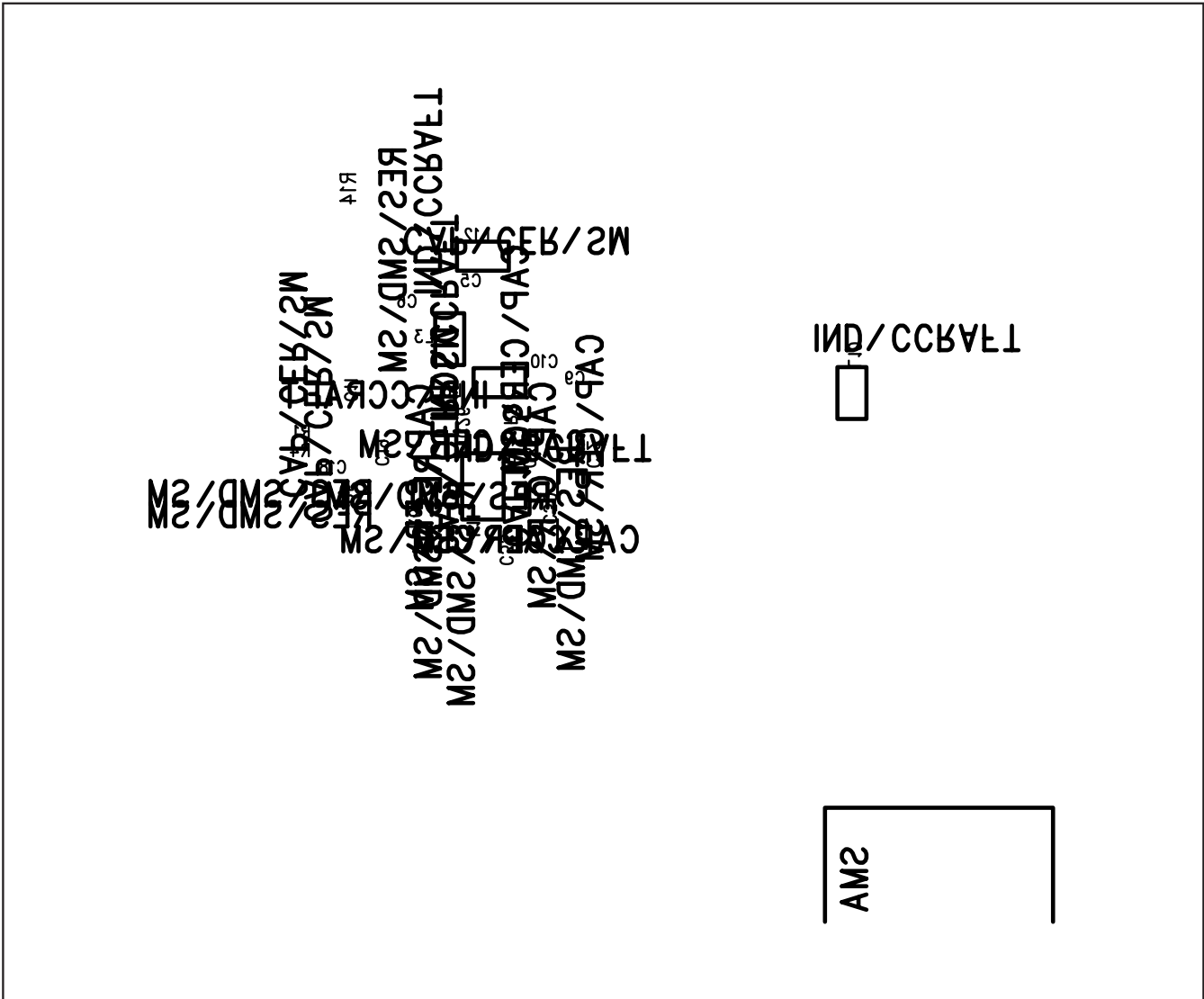

Figure 7. MAX2335 EV Kit Component Placement Guide—Bottom Silk

Maxim cannot assume responsibility for use of any circuitry other than circuitry entirely embodied in a Maxim product. No circuit patent licenses are implied. Maxim reserves the right to change the circuitry and specifications without notice at any time.

Maxim Integrated Products, 120 San Gabriel Drive, Sunnyvale, CA 94086 408-737-7600 _____ 9