

High IIP3 PIN Diode Variable Attenuator
1.70-2.00 GHz

MA4VAT2004-1061T
V2

Features

- RoHs and ELV compliant
- 1.4 dB Insertion Loss, Typical
- 1.4:1 VSWR, Typical
- 21 dB Attenuation, Typical
- 45 dBm IIP3, Typical
(1 MHz Offset, @ + 0 dBm Pinc)
- 0 – 1.66 Volts Control Voltage @ 1.50 mA Typical

Extra Features

- Covers the following Bands:
 - DCS
 - PCS
 - UMTS/WCDMA/CDMA
 - TD-S_CDMA
 - SCDMA
- Usable Bandwidth: 1.50 GHz to 2.50 GHz
- 1.8 dB Insertion Loss, Typical
- 2:1 VSWR, Typical
- 18.5 dB Attenuation, Typical

Description and Applications

M/A-COM's MA4VAT2004-1061T is a HMIC PIN Diode Variable Attenuator which utilizes an integrated 90 degree 3dB hybrid with a pair of Silicon PIN Diodes to perform the required attenuation function as D.C. Voltage (Current) is applied.

This device operates from 0 to 1.66 Volts at 1.50mA typical control current for maximum attenuation. The user can add external biasing resistors to the bias ports for higher voltage requirements as required.

M/A-COM's MA4VAT2004-1061T PIN Diode Variable Attenuator is designed for AGC Circuit Applications requiring:

- Lower Insertion Loss
- Lower distortion through attenuation
- Large dynamic range for wide spread spectrum applications

PIN Configuration (Topview)

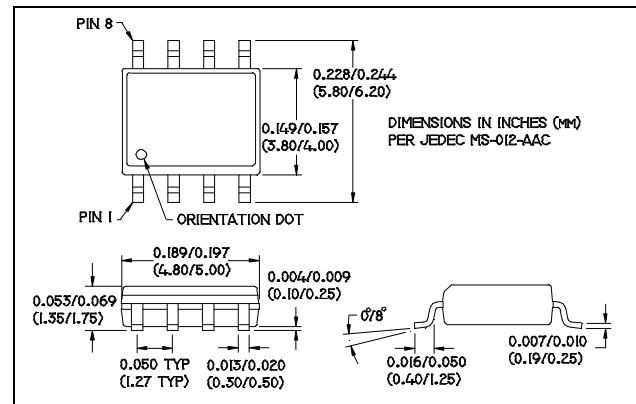

PIN Configuration (Topview)

PIN	Function	Comments
1	DC1	
2	GND	
3	GND	
4	RFin/out	Symetrical as RF Input/Ouput
5	RFout/in	Symetrical as RF Input/Ouput
6	GND	
7	GND	
8	DC2	

Absolute Maximum Ratings^{1,2}
@ T = +25 °C

Parameter	Maximum Ratings
Operating Temperature	-40 °C to +85 °C
Storage Temperature	-65 °C to +150 °C
Junction Temperature	+175 °C
RF C.W. Incident Power	+33 dBm C.W.
Reversed Current @ -30 V	I -50nA I
Control Current	50mA per Diode

1. All the above are at Room Temperature except as noted
2. Exceeding the above Limits may cause permanent damage

**High IIP3 PIN Diode Variable Attenuator
1.70-2.00 GHz**

**MA4VAT2004-1061T
V2**

Electrical Specifications @ +25 °C

Parameter	Frequency Band	Unit	Min	Typ	Max
No DC Bias Low Loss State					
Insertion Loss	1.70 GHz – 2.00 GHz	dB	-	1.4	1.8
Input Return Loss		dB	13	15	-
Output Return Loss		dB	13	15	-
P1dB		dBm	30	-	-
IIP3		dBm	47	49	-
Control Voltage		V	-	0V @ 0uA	-
DC Bias RF Attenuation State					
Maximum Attenuation	1.70 GHz – 2.00 GHz	dB	20	24	-
Input Return Loss @ Max Attenuation		dB	18	21	-
Output Return Loss @ Max Attenuation		dB	18	21	-
IP3		dBm	36	39	-
Control Voltage @ Max Attenuation		V	-	1.66V @ 1.50mA	-

Typical RF Performance Over Industry Designated RF Frequency Bands

Band		Freq	I. Loss	Att.	R. Loss	IIP3	Phase -Relative-
		(MHz)	(dB)	(dB)	(dB)	(dBm)	(Degree)
DCS	RX	1710-1785	1.6	22	13	50	+15°
	TX	1805-1880	1.6	22	13	50	
PCS	RX	1850-1910	1.6	21	13	50	+10°
	TX	1930-1990	1.6	21	13	50	
UMTS	RX	1920-1980	1.6	20	13	50	-5°
WCDMA/CDMA	TX	2110-2170	1.8	20	13	50	
TD-S-CDMA	-	2010-2025	1.7	20	13	50	-2°
SCDMA	-	1800-2200	1.8	20	13	50	-10°

1. All are typical values only.
2. Relative phase is the measured Insertion Phase Difference between Insertion Loss and the 20dB Attenuation State.
(Please refer to the plots below)

**High IIP3 PIN Diode Variable Attenuator
1.70-2.00 GHz**

**MA4VAT2004-1061T
V2**

Plots of Typical RF Characteristics @ + 25 °C

Typical Insertion Loss & Attenuation Plot

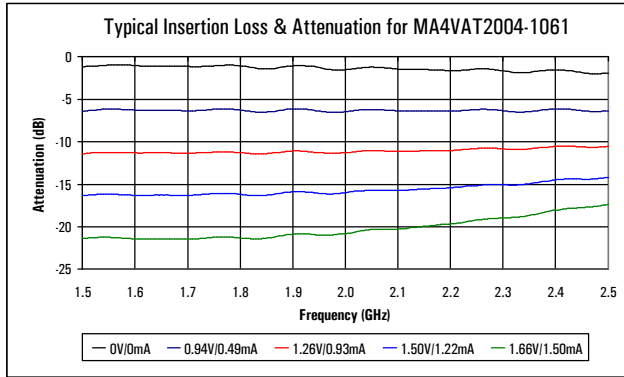

Typical Attenuation Vs Voltage Plot

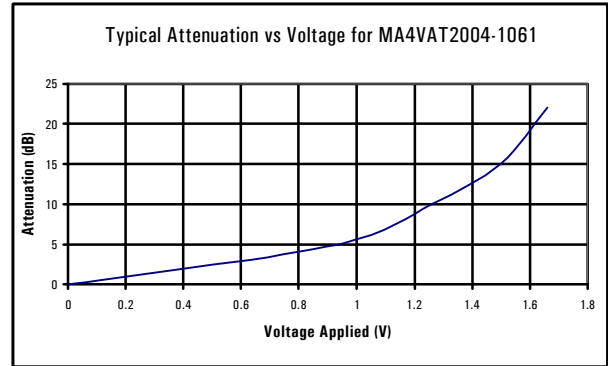

Typical Return Loss @ All Attenuation Levels Plot

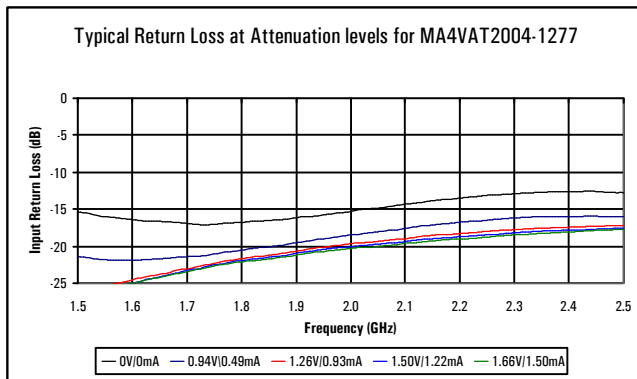

Typical IIP3 Vs Attenuation Plot

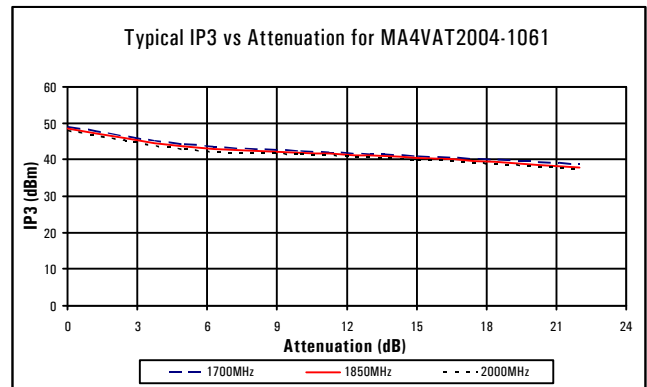

Typical Relative Phase Shift Per Attenuation (Voltage) Plot

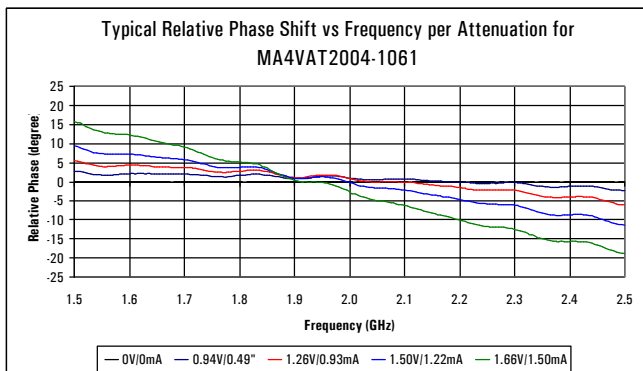

For Reference ONLY:

- Low Loss = 0.00V, @0.00mA
- 5 dB Attenuation = 0.94V, @0.49mA
- 10 dB Attenuation = 1.26V, @0.93mA
- 15 dB Attenuation = 1.50V, @1.22mA
- 20 dB Attenuation = 1.66V, @1.50mA

High IIP3 PIN Diode Variable Attenuator
1.70-2.00 GHz

MA4VAT2004-1061T
V2

Package Pin Designation, External Components, and Equivalent Circuit

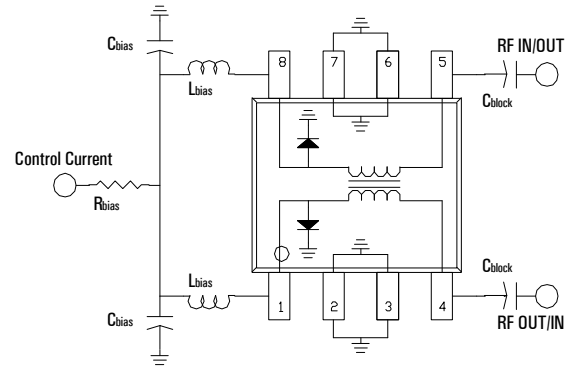
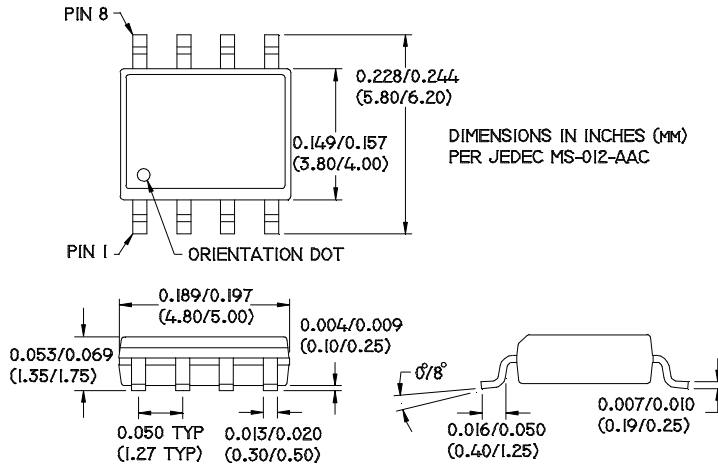

External Bias Components

R_{bias} = 680 Ohms (1.66 V, 1.50 mA)
 L_{bias} = 150 nH
 C_{bias} = 100 pF
 C_{block} = 100 pF

Ordering Information

Part Number	Package
MA4VAT2004-1061T	Tape and Reel