

DESCRIPTION

The LX8820 is an ultra low-dropout single output positive-voltage linear regulator. The regulator has a precise, fixed output capable of delivering 1.2 amps.

The LX8820 output is internally programmed for 3.3V.

Regulator stability is maintained with any capacitor ESR, allowing ceramic, tantalum or electrolytic types. Capacitance range is flexible beginning with 2.2 μ F to large values.

The CMOS wafer process increasing regulator efficiency by minimizing operating ground current (typically <200 μ A) compared to BiPolar technology .

The low $R_{DS(ON)}$ of the PMOS output stage results in ultra low dropout (typically 0.45V @ 1A).

Output voltage overshoot is controlled using slew rate control, as V_{IN} is applied, typically V_{OUT} overshoot < 2% for $V_{IN} \leq 1V/\mu$ S ramp. Transient response to a Step Load is fast and controlled, V_{OUT} overshoot remains within 2% of nominal for 400mA step sizes.

Thermal Shutdown, Current Limit and Short Circuit Current protection are integrated on-chip for survival during fault conditions.

Microsemi's small 3x3mm body size (MO-229) package enables maximum power dissipation with a minimum surface mount area.

KEY FEATURES

- Accurate Output Voltage
- Typical Dropout of 0.7V at 1A and 0.25V at 0.8A
- Independent Thermal and Current Limit Protection
- Low Tolerance Load Regulation (0.4%)
- Wide DC Supply Voltage of 4V to 10V
- Loop Stability Independent of Output Capacitor Type
- JEDEC MO-229 surface mount package / RoHS Compliant

APPLICATIONS/BENEFITS

- 5V to 3.3V Regulators
- Hard Disk Drives, CD-ROMs
- ADSL and Cable Modems
- Battery Charging Circuits
- Instrumentation
- PC Peripherals

IMPORTANT: For the most current data, consult MICROSEMI's website: <http://www.microsemi.com>

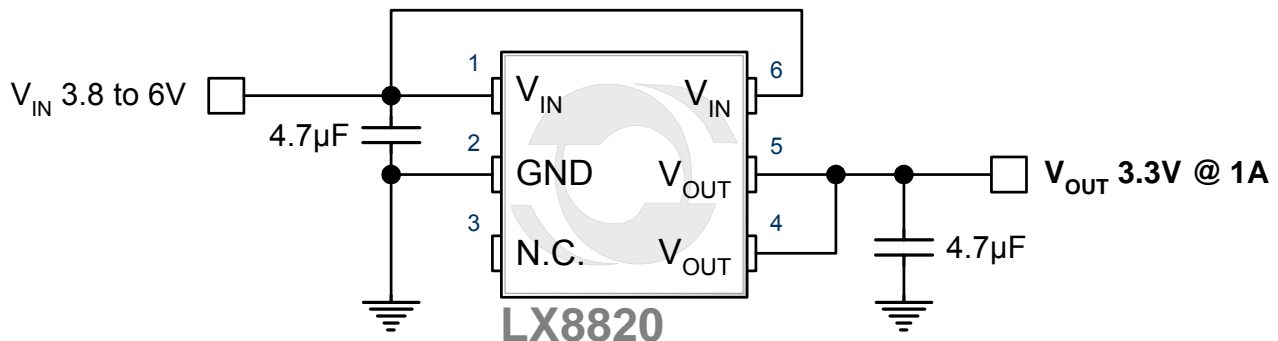
APPLICATION CIRCUITS

PACKAGE ORDER INFO

T_J (°C)	OUTPUT V	LM Plastic MLP 6-PIN RoHS Compliant / Pb-free	Part Marking
0 to 125	3.3V	LX8820-33CLM	882J or 8820

Note: Available in Tape & Reel. Append the letters "TR" to the part number. (i.e. LX8820-33CLM-TR)

ABSOLUTE MAXIMUM RATINGS

Input Voltage (V_{IN}).....	10V
Load Current (Internally Limited).....	2A
Power Dissipation.....	Internally Limited
Short-Circuit Protection.....	Indefinite
Operating Junction Temperature.....	150°C
Storage Temperature Range.....	-65°C to 150°C
RoHS / Pb-free Peak Package Solder Reflow Temperature (40 second maximum exposure).....	260°C (+0,-5)

Note: Exceeding these ratings could cause damage to the device. All voltages are with respect to Ground. Currents are positive into, negative out of specified terminal.

THERMAL DATA
LM Plastic MLP 6-Pin

THERMAL RESISTANCE-JUNCTION TO TAB, θ_{JT}	8°C/W
THERMAL RESISTANCE-JUNCTION TO AMBIENT, θ_{JA} (Typical, depending on mounting/pcb layout)	29-35°C/W

Junction Temperature Calculation: $T_J = T_A + (P_D \times \theta_{JA})$.
 The θ_{JA} numbers are guidelines for the thermal performance of the device/pc-board system. All of the above assume no ambient airflow. θ_{JA} can vary significantly depending on mounting technique. (See Application Notes Section: Thermal considerations)

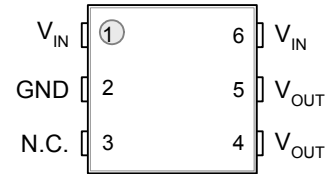
PACKAGE PIN OUT

LM PACKAGE
(Top View)

Heatsink must be connected to GND or left floating (see pg 7 for details)

N/C = Not internally connected, don't care for PCB layout consideration.

RoHS / Pb-free 100% Matte Tin Lead Finish

FUNCTIONAL PIN DESCRIPTION

PIN NAME	DESCRIPTION
V_{IN}	Positive unregulated supply input for the regulator. Bypass to GND with at least 2.2 μ F of low ESR and ESL capacitance.
GND	Common terminal for ground reference. The input and output bypass capacitors should be connected to this pin.
V_{OUT}	Regulator output. It is recommended to bypass to GND with at least 2.2 μ F. Size your output capacitor to meet the transient loading requirement. If you have a very dynamic load, a lower ESR capacitor will improve the response to these load steps.

RECOMMENDED MAX OPERATING CONDITIONS

Parameter	Symbol	LX8820-33			Units
		Min	Typ	Max	
Input Voltage	V_{IN}	4.5		10	V
Load Current (with adequate heat sinking)	I_L			1200	mA
Operating Junction Temperature	T_J			125	°C

ELECTRICAL CHARACTERISTICS

Unless otherwise specified, the following specifications apply over the operating ambient temperature $0^{\circ}\text{C} \leq T_A \leq 125^{\circ}\text{C}$ except where otherwise noted and the following test conditions: $V_{IN} = 5\text{V}$, $I_{OUT} = 10\text{mA}$, $C_1 = 4.7\mu\text{F}$ (ceramic), $C_2 = 4.7\mu\text{F}$ (ceramic), & $T_J = T_A$ using low duty cycling methods.

Parameter	Symbol	Test Conditions	LX8820-33			Units
			Min	Typ	Max	
Fixed Output (3.3V)						
Output Voltage	V_{OUT}	$5\text{mA} < I_{OUT} < 1\text{A}$, $4.75\text{V} < V_{IN} < 5.25\text{V}$	3.234	3.300	3.366	V
Line Regulation	$\Delta V_{OUT}(V_{IN})$	$4.5\text{V} < V_{IN} < 5.5\text{V}$, $5\text{mA} < I_{OUT} < 1\text{A}$		4	9	mV
Load Regulation	$\Delta V_{OUT}(I_{OUT})$	$10\text{mA} < I_{OUT} < 1\text{A}$, $V_{IN} = 4.75\text{V}$		2	15	mV
Dropout Voltage	V_{DO}	$I_{LOAD} = 1\text{A}$, $\Delta V_{OUT} = -1\%$		0.45		V
		$I_{LOAD} = 1\text{A}$, $V_{IN} = 4.0\text{V}$	3.0	3.3	3.383	
Transient Response; V_{OUT} Overshoot at Start-Up	V_{OUT}	V_{IN} step 0V to 5V; $t_r \geq 1\mu\text{s}$; $10\text{mA} < I_{OUT} < 1\text{A}$ Note 2			3.63	V
Transient Response; V_{OUT} Droop to Step Load	V_{OUT}	$V_{IN} = 5\text{V}$; $t_r \geq 1\mu\text{s}$; $10\text{mA} < I_{OUT} < 1\text{A}$ Note 2	3.0			V
Current Limit	$I_{OUT(MAX)}$	$V_{IN} < 5.5\text{V}$	1.0	1.5		A
Minimum Load Current	I_L	Note 1		0	0.1	mA
Quiescent Current	I_Q	$I_{OUT} = 5\text{mA}$		205	300	μA
		$I_{OUT} = 1000\text{mA}$, $V_{IN} < 7\text{V}$		550	650	
Ripple Rejection	PSRR	$f = 120\text{Hz}$, $V_{IN} = 5\text{V}$	50	75		dB
RMS Output Noise (% of V_{OUT})	$V_{OUT(RMS)}$	$10\text{Hz} < f < 10\text{kHz}$		0.003		%/V
Thermal Shutdown	T_{JSD}		140	160		$^{\circ}\text{C}$

Note 1: Minimum load current is defined as the amount of output current required to maintain regulation.

Note 2: Guaranteed by design.

BLOCK DIAGRAM

Figure 1 – Fixed Output

Note: Application Circuit above using ceramic capacitors

CHARACTERISTIC CURVES
LX8820 TEMP STABILITY, $I_{out}=5\text{ma}$

STEP LOAD STABILITY

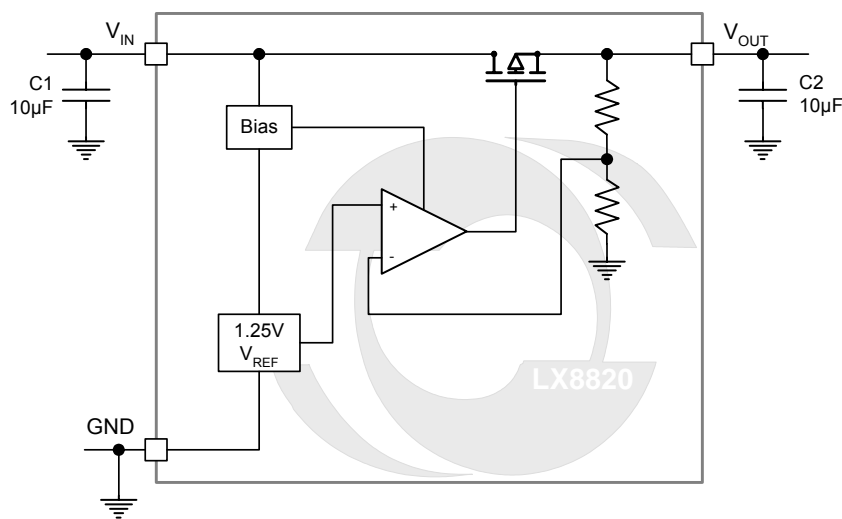
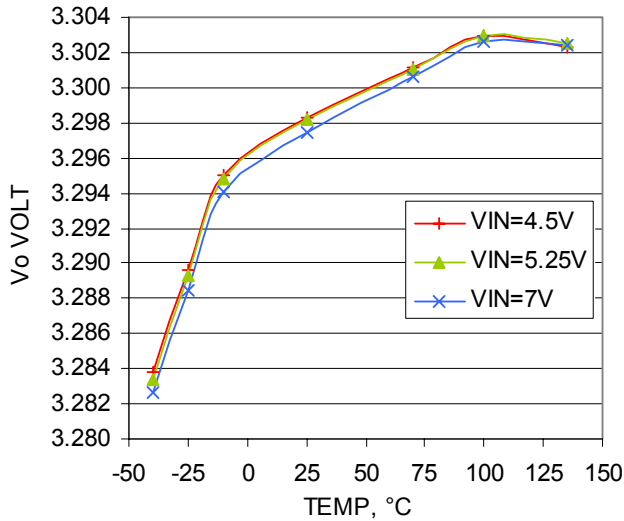
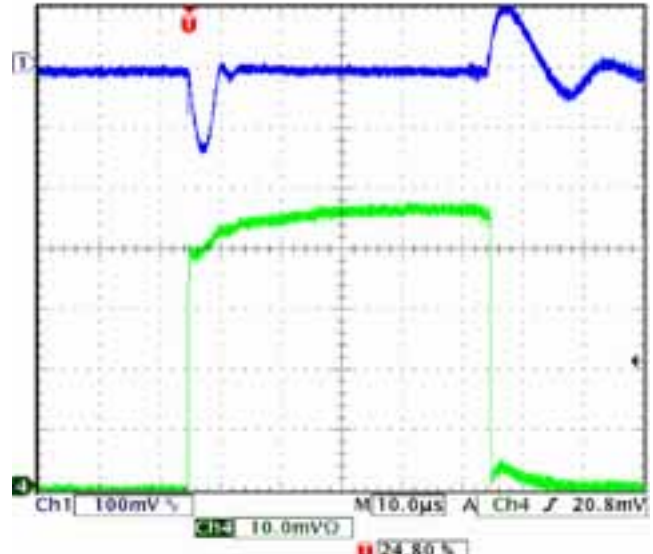
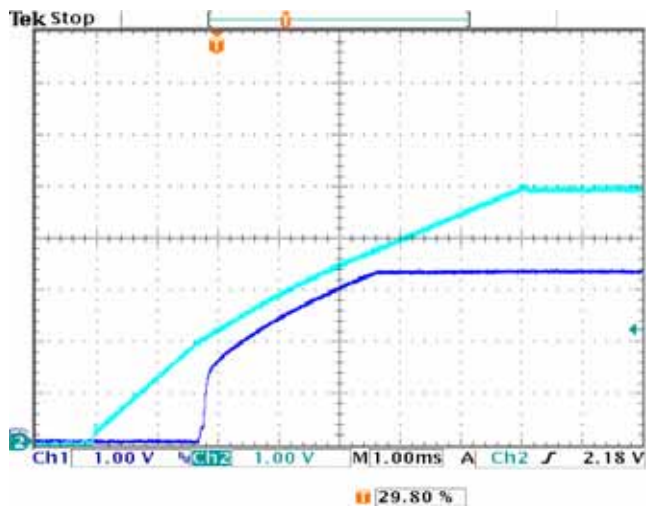
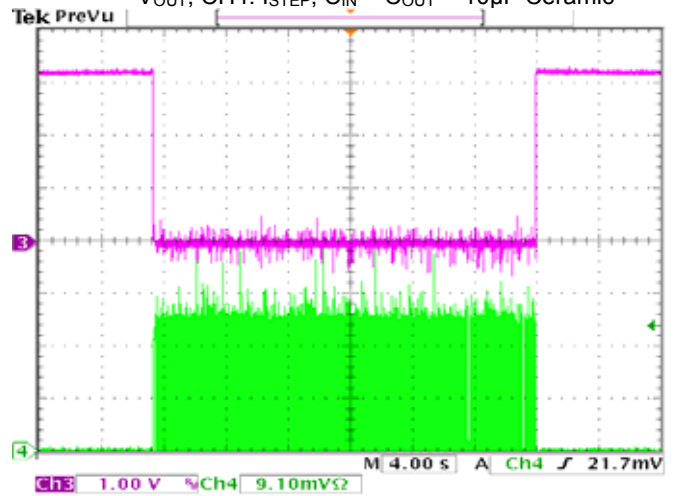
SUPPLY VOLTAGE, FAST TURN ON ($T_{RISE} = 10\mu\text{s}$)

SHORT CIRCUIT AND RECOVERY
 V_{OUT} , CH4: I_{STEP} , $C_{IN} = C_{OUT} = 10\mu\text{F}$ Ceramic

APPLICATION INFORMATION**Description**

The LX8820 is part of a family of LDO (Low Drop-Out) linear regulators in the JEDEC MO-229 package that offer maximum power dissipation in a low profile surface mount technology. The LX8820 output is fixed at 3.3V output and can supply up to one amp with a regulator design optimized for system efficiency by consuming minimal ground current and directing quiescent current to the load.

Input Capacitor

To improve load transient response and noise rejection an input bypass capacitor of at least 2.2 μ F is required. Generally we recommend a 4.7 μ F ceramic or tantalum or 22 μ F electrolytic capacitor.

Output Capacitor

The regulator requires an output capacitor connected between V_{OUT} to GND to stabilize the internal control loop. Many types of capacitors are available, with different capacitance values tolerances, temperature coefficients and equivalent series resistance. We recommend a minimum of 4.7 μ F. To ensure good transient response from the power supply system under rapidly changing current load conditions, designers generally use additional output capacitors connected in parallel. Such an arrangement serves to minimize the effects of the parasitic resistance (ESR) and inductance (ESL) that are present in all capacitors. The regulator has been tested stable with capacitor ESR's in the range of 0.01 to 2 ohms. We have found it best to use the same type of capacitor for both input and output bypass.

Minimum Load Requirement

The LX8820 has a minimum load requirement for proper output regulation specified at 0.1mA.

Temperature Protection

The thermal protection shuts the LX8820 down when the junction temperature exceeds 140°C. Exposure to absolute maximum rated conditions for extended periods may affect device reliability (see Thermal Considerations below).

Current Limit Protection

The LX8820 includes over current protection. When the output load current exceeds typically 1.5A, the circuit forces the regulator output to decrease.

Thermal Considerations

Thermal shutdown protects the integrated circuit from thermal overload caused from a rise in junction temperature during power dissipation. This means of protection is intended for fault protection only and not as a means of current or power limiting during normal application usage. Proper thermal evaluation should be done to ensure that the junction temperature does not exceed its maximum rating. Operating at the maximum T_J of 150°C can impact reliability. Due to variation in individual device electrical characteristics and thermal resistance, the built in thermal overload protection may be activated at power levels slightly above or below the rated dissipation. Also peak output power should be considered for each individual output.

Power dissipation for the regulator can be calculated using the following equation:

$$P_D = (V_{IN(MAX)} - V_{OUT}) \cdot I_{OUT}$$

(Note: power dissipation resulting from quiescent (ground) current is negligible)

Junction temperature of the integrated circuit can be calculated using:

$$T_{JUNCTION} = T_{JUNCTION-TABRISE} + T_{TAB-AMBRise} + T_{AMB}$$

$$T_{TAB} = P_{DMAX} \cdot \Theta_{JT}$$

$$T_{TAB-AMB} = P_{DREG} \cdot \Theta_{PCB}$$

An example: Given conditions: $T_A = 70^\circ\text{C}$, $V_{IN} = 5.0\text{V}$, $V_{out} = 3.3\text{V}$, $I_{out} = 200\text{mA}$.

Calculated values:

$$\begin{aligned} T_{J-TABREG} &= (5\text{V} - 3.3\text{V}) \cdot (200\text{mA}) \cdot 8^\circ\text{C/W} \\ &= (340\text{mW}) \cdot 8^\circ\text{C/W} = 2.7^\circ\text{C} \end{aligned}$$

$$T_{TAB-AMBRise} = (340\text{mW}) \cdot 32^\circ\text{C/W} = 10.9^\circ\text{C}$$

$$T_{JUNCTION} = 2.7^\circ\text{C} + 10.9^\circ\text{C} + 70^\circ\text{C} = 83.6^\circ\text{C}$$

It is important to note that although each output of the regulator will produce up to 1.5A in current, the total power dissipation may limit the useful total current draw. The junction temperature should be calculated to insure the maximum junction temperature is not exceeded.

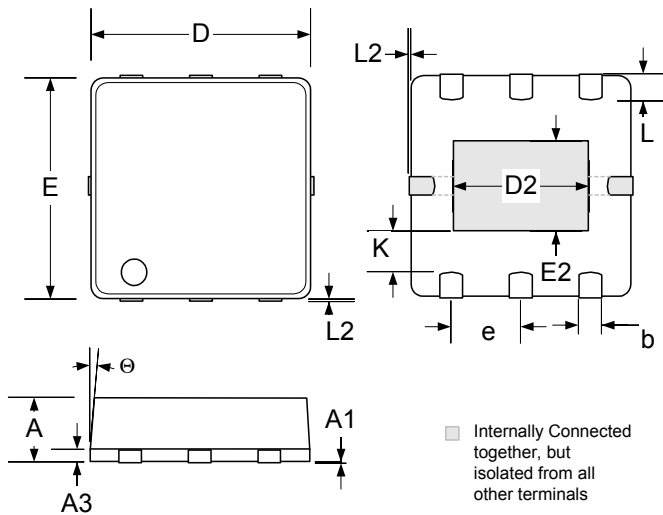
MECHANICAL DRAWINGS
JEDEC – MO229 6-Pin Plastic Micro Lead Package

Dim	MILLIMETERS		INCHES	
	MIN	MAX	MIN	MAX
A	0.80	1.00	0.032	0.040
A1	0.00	0.05	0	0.002
A3	0.20 REF		0.008 REF	
b	0.30	0.45	0.012	0.018
D	2.90	3.10	0.114	0.122
E	2.90	3.10	0.114	0.122
e	0.95 BSC		0.037 BSC	
D2	1.90	2.25	0.075	0.086
E2	1.15	1.65	0.045	0.065
K	0.20	-	0.008	-
L	0.30	0.45	0.012	0.018
L2	-	0.10	-	0.004
θ	0°	12°	0°	12°

NOTES

PRODUCTION DATA – Information contained in this document is proprietary to Microsemi and is current as of publication date. This document may not be modified in any way without the express written consent of Microsemi. Product processing does not necessarily include testing of all parameters. Microsemi reserves the right to change the configuration and performance of the product and to discontinue product at any time.