

OBSOLETE:
 FOR INFORMATION PURPOSES ONLY
 Contact Linear Technology for Potential Replacement

FEATURES

- **UL Recognized**  File E151738 to UL1577
- **No Secondary Power Supply**
- **Drives Any Logic Level FET**
- Low Input Current: 1mA Typ (LTC1177-5), 2.5mA Typ (LTC1177-12)
- Turns On in 1ms Typ and Turns Off in 1ms Typ
- 2500V_{RMS} of Isolation Voltage
- Isolates Input from High Voltage Transients at Load
- Clean, Bounce-Free Switching
- Current Limit
- Small Outline Package

APPLICATIONS

- Solid State Relay
- Isolated Solenoid Driver
- Isolated Motor Driver
- Isolated Lamp Driver

DESCRIPTION

The LTC[®]1177-5/LTC1177-12 are isolated high side MOSFET drivers. When used with an external N-channel MOSFET, the LTC1177-5/LTC1177-12 form an isolated solid state switch for reliable bounce-free switching operation. The output does not require an auxiliary power supply to maintain an on-state condition.

Two lead frame capacitors are used to transfer energy from the input to drive the gate of the MOSFET and provide the necessary isolation. Unlike optoisolated FET drivers, the input current for the LTC1177-5 is only 1mA and 2.5mA for LTC1177-12. It also does not have the aging problems endemic to optocouplers.

Both devices provide 2500V_{RMS} (1 minute) or 3000V_{RMS} (1 second) of output-to-input isolation.

The LTC1177-5/LTC1177-12 are available in the 18-pin PDIP or 28-pin SW package.

 LTC and LT are registered trademarks of Linear Technology Corporation.

TYPICAL APPLICATION

Isolated High Side Switch

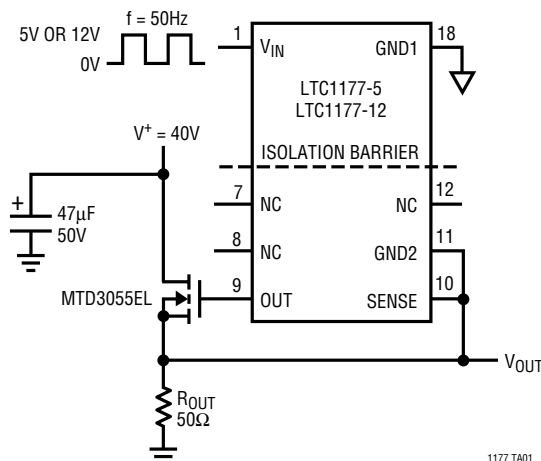

Input vs Output

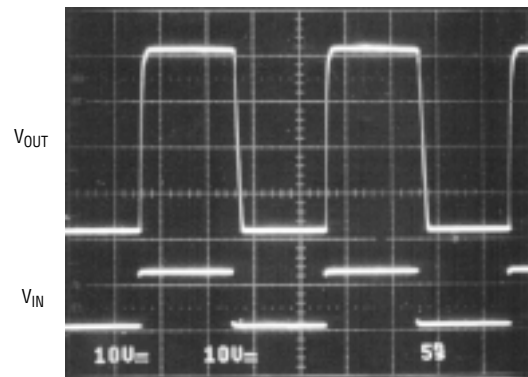

1177 TA02

LTC1177-5/LTC1177-12

ABSOLUTE MAXIMUM RATINGS

Input Voltages

V_{IN} (LTC1177-5)	6V to (GND1 – 0.3V)
V_{IN} (LTC1177-12)	13.2V to (GND1 – 0.3V)
Sense (LTC1177-5)	6V to (GND2 – 0.3V)
Sense (LTC1177-12)	12V to (GND2 – 0.3V)
Output Voltages	12V to (GND2 – 0.3V)

Operating Temperature Range

Commercial	0°C to 70°C
Industrial	–40°C to 85°C
Storage Temperature Range	–65°C to 150°C
Lead Temperature (Soldering, 10 sec)	300°C

PACKAGE/ORDER INFORMATION

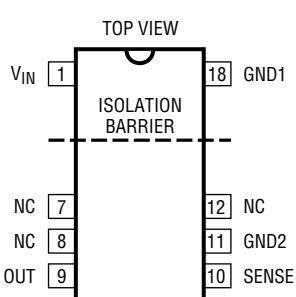
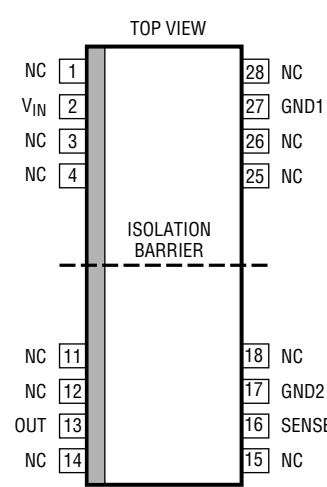
	ORDER PART NUMBER	TOP VIEW	ORDER PART NUMBER
 <p>N PACKAGE 18-LEAD PDIP ISOLATION BARRIER $T_{JMAX} = 125^{\circ}\text{C}$, $\theta_{JA} = 110^{\circ}\text{C/W}$</p>	<p>LTC1177CN-5 LTC1177CN-12 LTC1177IN-5 LTC1177IN-12</p>	 <p>SW PACKAGE 28-LEAD PLASTIC SO WIDE ISOLATION BARRIER $T_{JMAX} = 125^{\circ}\text{C}$, $\theta_{JA} = 125^{\circ}\text{C/W}$</p>	<p>LTC1177CSW-5 LTC1177CSW-12 LTC1177ISW-5 LTC1177ISW-12</p>

Consult factory for Military grade parts.

ELECTRICAL CHARACTERISTICS

$V_{IN} = 5\text{V}$, $T_A = 25^{\circ}\text{C}$, unless otherwise noted.

SYMBOL	PARAMETER	CONDITIONS	LTC1177-5			UNITS	
			MIN	TYP	MAX		
V_{OUT}	Output Voltage (Refer to GND2)	$C_{OUT} = 1000\text{pF}$, No Load (N Pkg)	●	6.5	7.5	10	V
		$C_{OUT} = 1000\text{pF}$, No Load, $V_{IN} = 4.75\text{V}$ (N Pkg)	●	5.5	6.5	10	V
		$C_{OUT} = 1000\text{pF}$, No Load (SW Pkg)	●	7.0	8.0	10	V
		$C_{OUT} = 1000\text{pF}$, No Load, $V_{IN} = 4.75\text{V}$ (SW Pkg)	●	6.0	7.0	10	V
I_{IN}	Input Current	$C_{IN} = 1000\text{pF}$	●		1.0	1.5	mA
I_{LIM}	Current Limit	$R_{SENSE} = 1\Omega$ (LTC1177C-5)	●	400	620	800	mA
		$R_{SENSE} = 1\Omega$ (LTC1177I-5)	●	350	620	900	mA
t_{ON}	Turn-On Time	$C_{OUT} = 1000\text{pF}$, No Load (LTC1177C-5)	●		1.0	4.0	ms
		$C_{OUT} = 1000\text{pF}$, No Load (LTC1177I-5)	●		1.0	4.5	ms
t_{OFF}	Turn-Off Time	$C_{OUT} = 1000\text{pF}$, No Load	●		1.0	1.8	ms
V_{ISO}	Isolation Voltage	1 Minute (Note 1)		2500			V_{RMS}
		1 Second		3000			V_{RMS}
t_{CM}	Common Mode Slew Rate	$V_{OUT} < 1.5$, $C_{OUT} = 1000\text{pF}$				1000	$\text{V}/\mu\text{s}$

ELECTRICAL CHARACTERISTICS $V_{IN} = 12V, T_A = 25^\circ C$ unless otherwise noted.

SYMBOL	PARAMETER	CONDITIONS	LTC1177-12			UNITS	
			MIN	TYP	MAX		
V_{OUT}	Output Voltage (Refer to GND2)	$C_{OUT} = 1000\mu F$, No Load (LTC1177C-12, N Pkg)	●	4.65	5.2	8	V
		$C_{OUT} = 1000\mu F$, No Load (LTC1177C-12, SW Pkg)	●	5.00	5.7	8	V
		$C_{OUT} = 1000\mu F, V_{IN} = 11.4V$ (LTC1177C-12, N Pkg)	●	4.40	4.9	7	V
		$C_{OUT} = 1000\mu F, V_{IN} = 11.4V$ (LTC1177C-12, SW Pkg)	●	4.60	5.3	7	V
		$C_{OUT} = 1000\mu F$, No Load (LTC1177I-12, N Pkg)	●	4.50	5.2	8	V
		$C_{OUT} = 1000\mu F$, No Load (LTC1177I-12, SW Pkg)	●	4.75	5.7	8	V
		$C_{OUT} = 1000\mu F, V_{IN} = 11.4V$ (LTC1177I-12, SW Pkg)	●	4.50	5.3	7	V
I_{IN}	Input Current	$C_{IN} = 1000\mu F$ (LTC1177C-12)	●		2.5	3.0	mA
		$C_{IN} = 1000\mu F$ (LTC1177I-12)	●		2.5	3.4	mA
I_{LIM}	Current Limit	$R_{SENSE} = 1\Omega$ (LTC1177C-12)	●	400	620	800	mA
		$R_{SENSE} = 1\Omega$ (LTC1177I-12)	●	350	620	900	mA
t_{ON}	Turn-On Time	$C_{OUT} = 1000\mu F$, No Load (LTC1177C-12)	●		1.0	2.5	ms
		$C_{OUT} = 1000\mu F$, No Load (LTC1177I-12, N Pkg)			1.0		ms
		$C_{OUT} = 1000\mu F$, No Load (LTC1177I-12, SW Pkg)	●		1.0	2.5	ms
t_{OFF}	Turn-Off Time	$C_{OUT} = 1000\mu F$, No Load (LTC1177C-12)	●		1.0	1.2	ms
		$C_{OUT} = 1000\mu F$, No Load (LTC1177I-12, N Pkg)			1.0		ms
		$C_{OUT} = 1000\mu F$, No Load (LTC1177I-12, SW Pkg)	●		1.0	1.5	ms
V_{ISO}	Isolation Voltage	1 Minute (Note 1)		2500			V_{RMS}
		1 Second		3000			V_{RMS}
TCM	Common Mode Slew Rate	$V_{OUT} < 1.5V, C_{OUT} = 1000\mu F$				1000	$V/\mu s$

The ● denotes specifications which apply over the full operating temperature range.

Note 1: Value derived from 1 second test.

TYPICAL PERFORMANCE CHARACTERISTICS

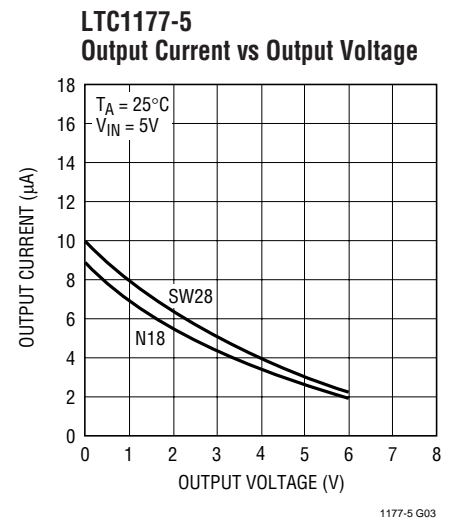
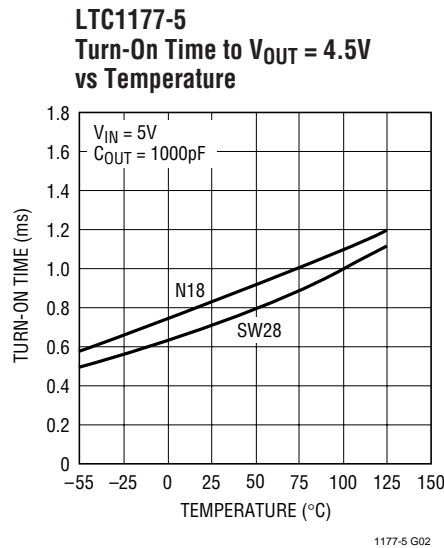
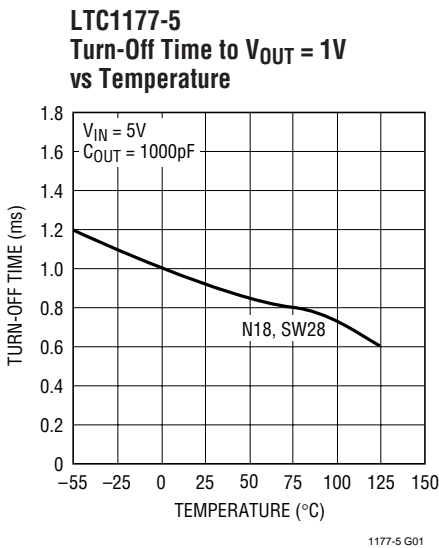

TYPICAL PERFORMANCE CHARACTERISTICS

LTC1177-5
Output Voltage vs Temperature

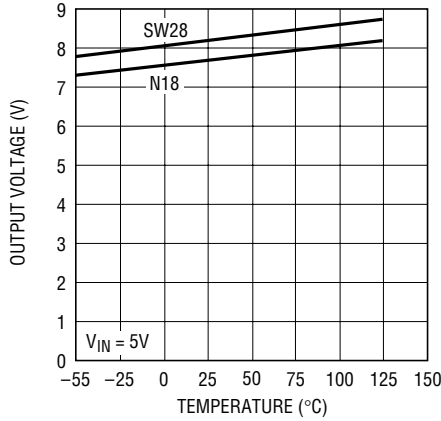

1177-5 G04

LTC1177-5
Input Current vs Temperature

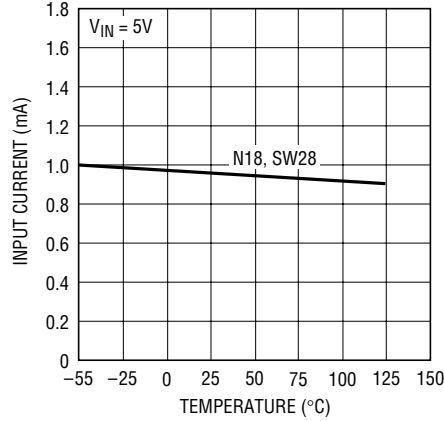

1177-5 G05

LTC1177-5
Output Voltage vs Input Voltage

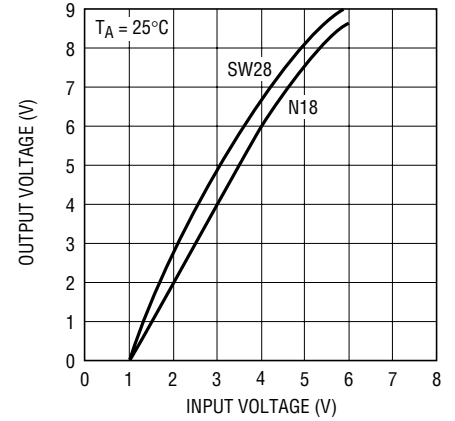

1177-5 G06

LTC1177-5
Input Current vs Input Voltage

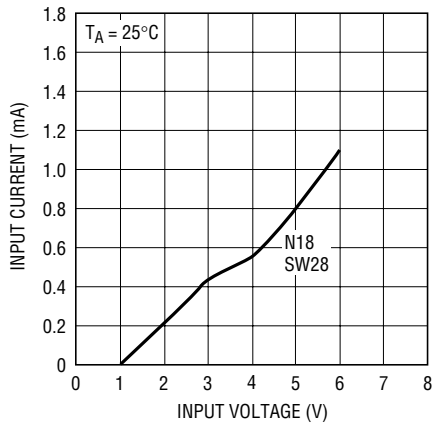

1177-5 G07

LTC1177-12 Turn-Off Time to $V_{OUT} = 1V$ vs Temperature

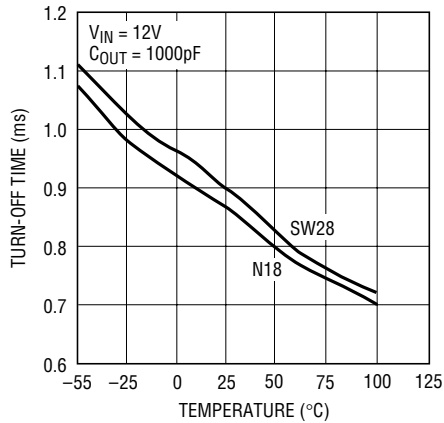

1177-12 G08

LTC1177-12 Turn-On Time to $V_{OUT} = 4.5V$ vs Temperature

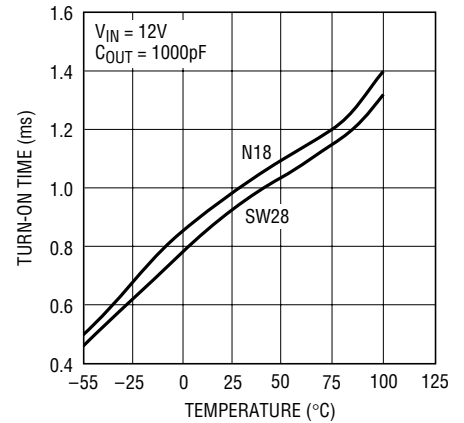

1177-12 G09

LTC1177-12
Turn-On Time to $V_{OUT} = 4.5V$ vs Output Capacitance

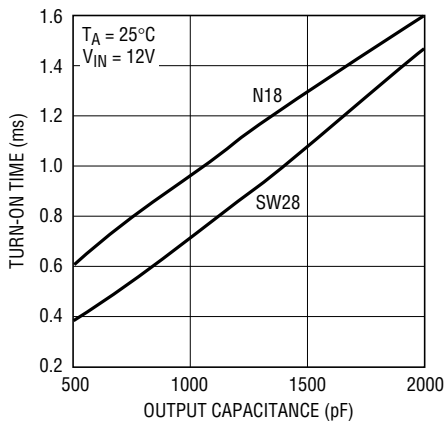

1177-12 G10

LTC1177-12
Turn-Off Time to $V_{OUT} = 1V$ vs Output Capacitance

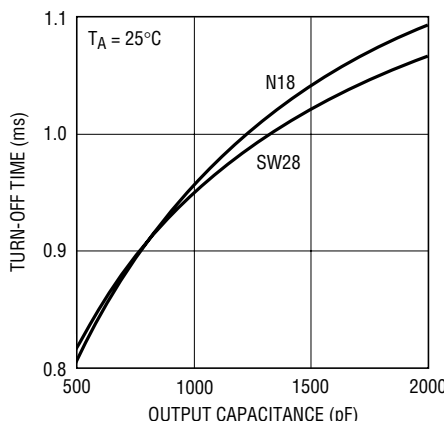

1177-12 G11

LTC1177-12
Output Current vs Output Voltage

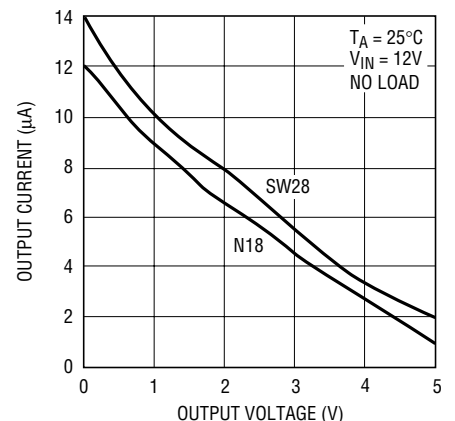

1177-12 G12

TYPICAL PERFORMANCE CHARACTERISTICS

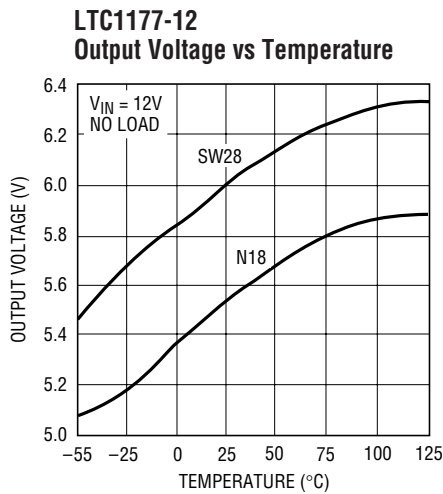

1177-12 G13

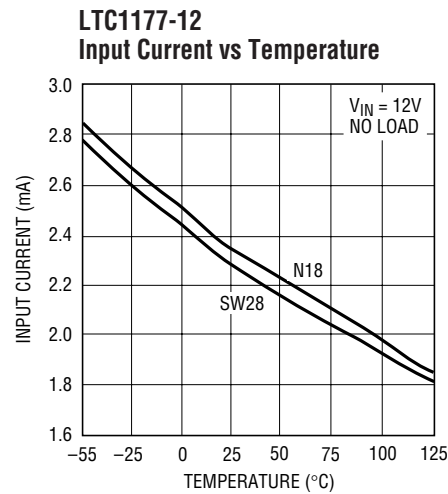

1177-12 G14

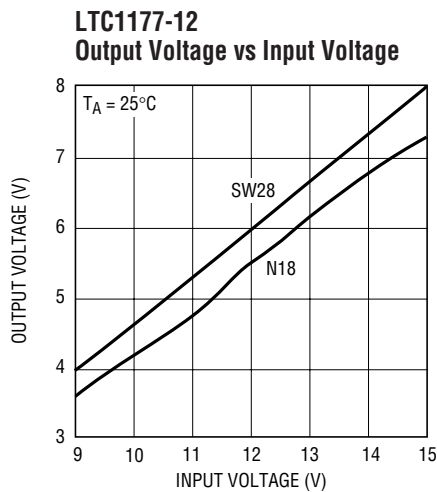

1177-12 G15

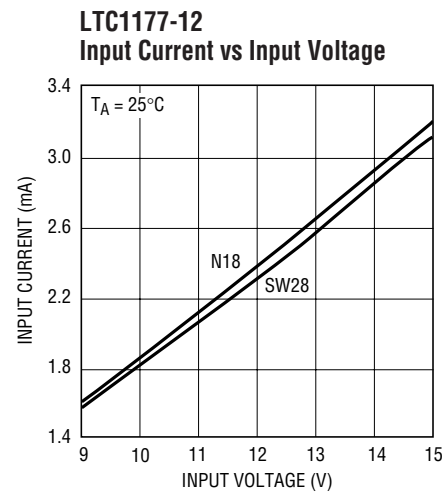

1177-12 G16

PIN FUNCTIONS

V_{IN}: Voltage Input, $5.25V \geq V_{IN} \geq 4.75V$ (LTC1177-5) and $12.6V \geq V_{IN} \geq 11.4V$ (LTC1177-12). Connect a $0.01\mu F$ capacitor between V_{IN} and GND1 when the source impedance is high or the V_{IN} connection is long.

OUT: Output Voltage. The output voltage level is 8V (typ) for SW package and 7.5V (typ) for N package (LTC1177-5) with 5V at V_{IN} pin; 5.7V (typ) for SW package and 5.2V (typ) for N package (LTC1177-12) with 12V at V_{IN} pin. This pin is to drive the gate of the external N-channel MOSFET.

SENSE: Current Limit Sense Input. Connecting a 1Ω resistor from the Sense pin to GND2 limits the current through the power MOSFET to 620mA (typ). $I_{LIM} = 620mV/R_{SENSE}$.

GND2: Floating Ground Connects to the source of the external N-channel MOSFET.

GND1: Input Ground. The ground connection of the input control signal.

BLOCK DIAGRAM

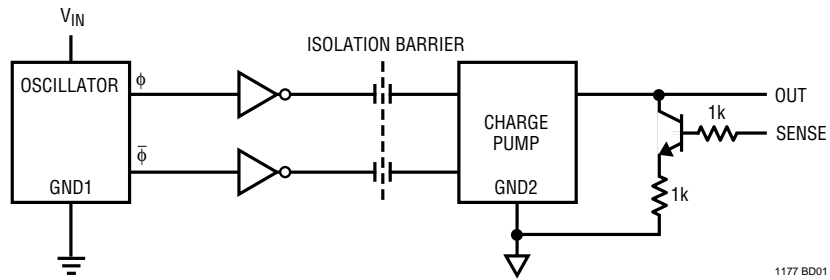

SWITCHING WAVEFORMS

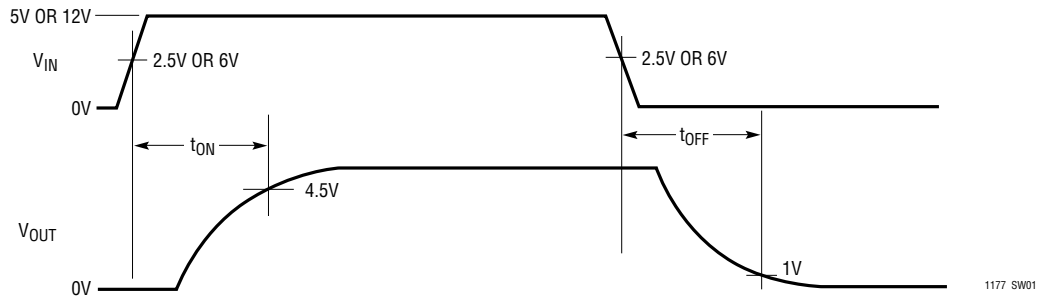

TYPICAL APPLICATIONS

Solid State Relay

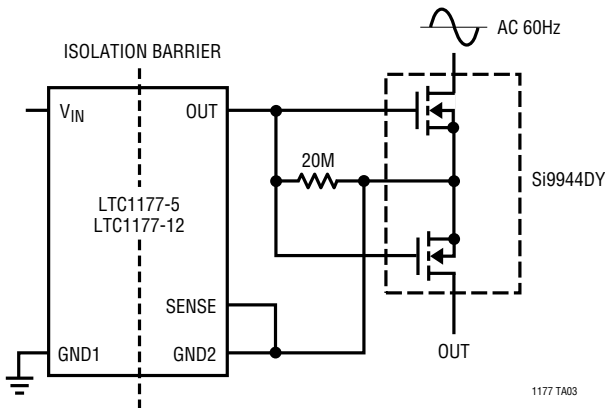

Isolated High Side Switch with Fold-Back Current Limit

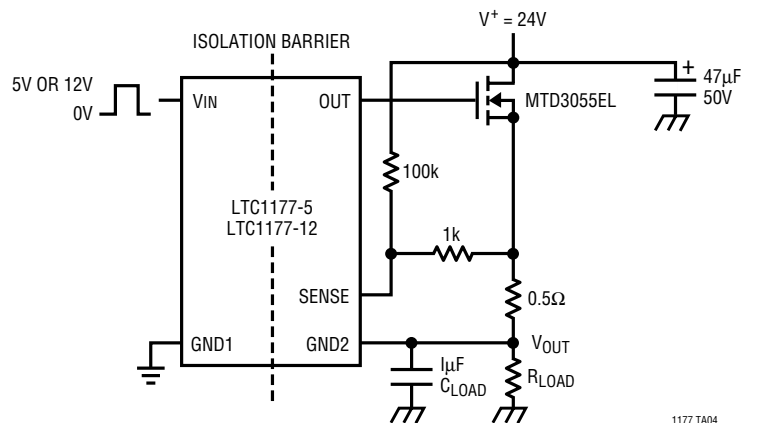

PACKAGE DESCRIPTION Dimensions in inches (millimeters) unless otherwise noted.

N Package
18-Lead PDIP Isolation Barrier (Narrow 0.300)
 (LTC DWG # 05-08-1590)

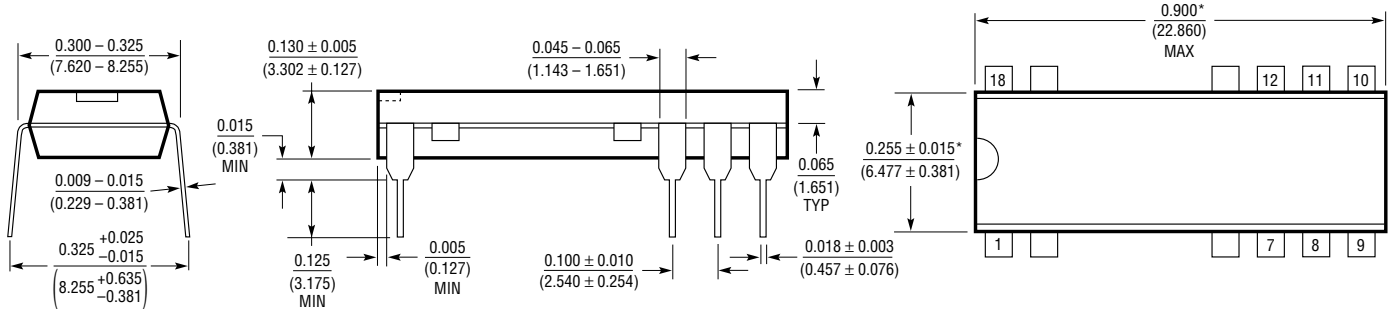

*THESE DIMENSIONS DO NOT INCLUDE MOLD FLASH OR PROTRUSIONS.
 MOLD FLASH OR PROTRUSIONS SHALL NOT EXCEED 0.010 INCH (0.254mm)

SW Package
28-Lead Plastic Small Outline Isolation Barrier (Wide 0.300)
 (LTC DWG # 05-08-1690)

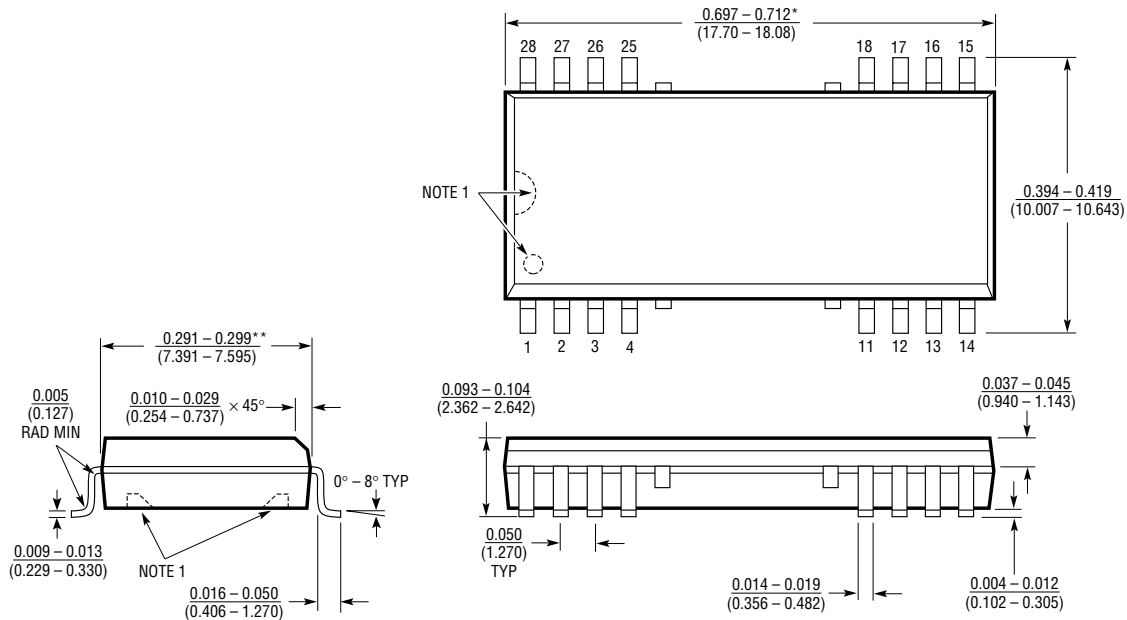

NOTE:
 1. PIN 1 IDENT, NOTCH ON TOP AND CAVITIES ON THE BOTTOM OF PACKAGES ARE THE MANUFACTURING OPTIONS
 THE PART MAY BE SUPPLIED WITH OR WITHOUT ANY OF THE OPTIONS.
 *DIMENSION DOES NOT INCLUDE MOLD FLASH. MOLD FLASH SHALL NOT EXCEED 0.006" (0.152mm) PER SIDE
 **DIMENSION DOES NOT INCLUDE INTERLEAD FLASH. INTERLEAD FLASH SHALL NOT EXCEED 0.010" (0.254mm) PER SIDE

RELATED PARTS

PART NUMBER	DESCRIPTION	COMMENTS
LTC1145/LTC1146	Low Power Digital Isolator	Passes Digital Information Across Isolation Barrier
LT [®] 1158	Half-Bridge N-Channel Power MOSFET Driver	Useful for Motor Speed Control, Synchronous Switching Regulator
LTC1255	Dual 24V High Side MOSFET Driver	User Set Current Limiting