

PANEL DISPLAY UNITS

96 × 96 mm

φ 5 mm 16 × 16 Dots LNP125041

Outline Drawing

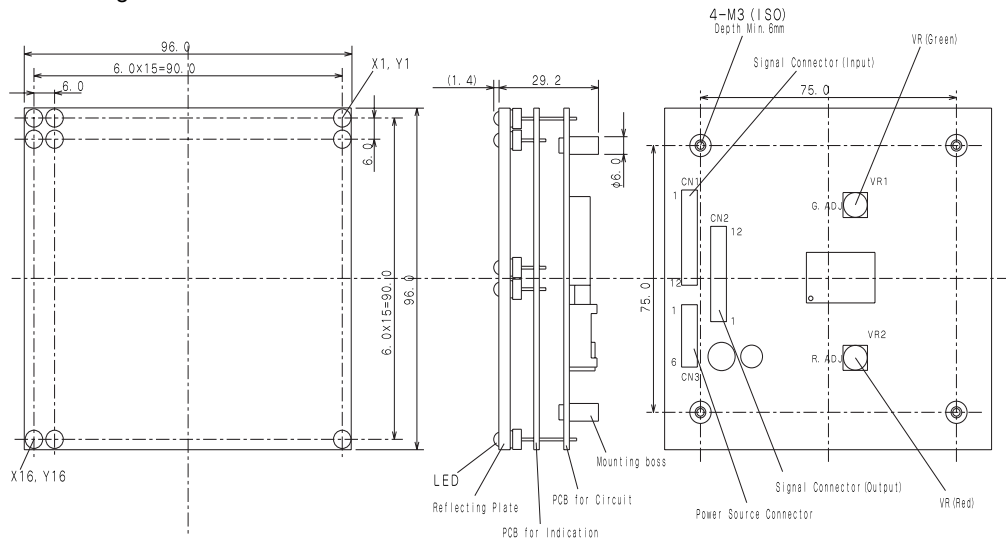

Absolute Maximum Ratings (Ta = 25°C)

Item	Symbol	Ratings	Unit
Supply Voltage for Logic	V _{CC}	- 0.3 ~ + 6.0	V
Supply Voltage for LED	V _{LED}	Max 5.5	V
Input Voltage	V _{in}	- 0.3 ~ V _{CC} + 0.3	V
Operating Ambient Temperature	Topr	- 10 ~ + 45	°C
Storage Temperature	Tstg	- 25 ~ + 85	°C

Main Specifications (Ta = 25°C)

Item	Symbol	Ratings	Unit	
Display Colors		Red, Green, Amber		
Dot Diameter		φ 5.0	mm	
Dots Pitch		6.0	mm	
Dot Total Number		256 (16 × 16)		
Display Surface Size		96 × 96	mm	
Brightness (when lighting all lamps)	B	Red : 250 Green : 250 Controllable	cd/m ²	
Operating Method		1/16(Duty) Dynamic lighting		
Clock Frequency	CLK	Max 20	MHz	
for Logic	Supply Voltage	V _{CC}	5.0 ± 0.25	V
	Supply Current	I _{CC}	Max 40	mA
for LED	Supply Voltage	V _{LED}	5.0 ± 0.2	V
	Supply Current	I _{LED}	Max 2.8 when two colors are all turned "ON"	A
Weight		175	g	