

Surface Mount

# Frequency Mixer

## LAVI-10VH+

Level 21 (LO Power +21dBm) 300 to 1000 MHz

### Maximum Ratings

Operating Temperature	-45°C to 85°C
Storage Temperature	-55°C to 100°C
LO Power	+24 dBm
RF Power	+23 dBm

### Pin Connections

LO	10
RF	2
IF	14
GROUND	1,3,4,5,6,7,8,9,11,12,13,15,16

### Features

- RoHS compliant
- very high IP3, 33 dBm typ.
- wideband, 300 to 1000 MHz
- excellent L-R isolation, 50 dB typ. and L-I isolation, 45 dB typ.
- high 1 dB compression, 20 dBm typ.
- shielded metal cover
- U.S. patent 6,807,407

### Applications

- cellular base stations
- mobile radio
- defense communications

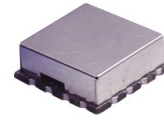

CASE STYLE: CK605  
 PRICE: \$22.95 ea. QTY (1-9)  
 \$15.95 ea. QTY. (100)

**+ RoHS compliant in accordance with EU Directive (2002/95/EC)**

*The +suffix has been added in order to identify RoHS Compliance. There has been no change to the model's material, form, fit, or function. See our web site for RoHS Compliance methodologies and qualifications.*

### Outline Drawing

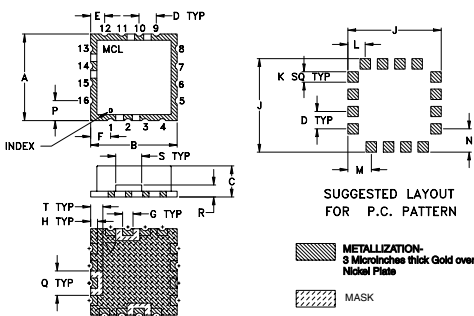

### Outline Dimensions (inch)

A	B	C	D	E	F	G	H	J	
.500	.500	.180	.100	.080	.115	.060	.040	.540	
12.70	12.70	4.57	2.54	2.03	2.92	1.52	1.02	13.72	
K	L	M	N	P	Q	R	S	T	wt.
.060	.100	.135	.135	.115	.140	.070	.150	.070	grams
1.52	1.50	3.43	3.43	2.92	3.56	1.78	3.81	1.78	1.0

### Demo Board MCL P/N: TB-10 Suggested PCB Layout (PL-012)

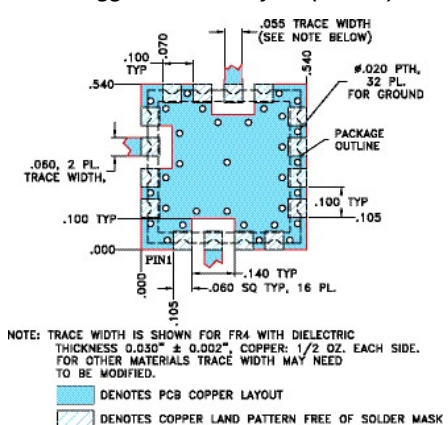

### Electrical Specifications (T<sub>AMB</sub>=25°C)

FREQUENCY (MHz)			CONVERSION LOSS (dB)			RF in at 1dB Compr (dBm)	IP3 (dBm)	LO-RF ISOLATION (dB)		LO-IF ISOLATION (dB)	
RF	LO	IF	Typ.	$\sigma$	Max.	Typ.	Typ.	Typ.	Min.	Typ.	Min.
300-1000	525-1175	60-875	6.3	0.12	8.0	+20	33	50	40	45	30

### Typical Performance Data

Frequency		Conversion Loss (dB)	Isolation L-R (dB)	Isolation L-I (dB)	VSWR RF (-:1)	VSWR LO (-:1)	IP3 (dBm)	IF Freq. (MHz)	VSWR IF (-:1)
RF MHz	LO MHz	LO +21dBm	LO +21dBm	LO +21 dBm	LO +21 dBm	LO +21 dBm	LO +21 dBm	LO +21 dBm	LO +21 dBm
300.10	475.00	6.01	61.98	47.09	1.53	8.60	32.29	60.00	2.37
350.10	525.00	6.17	57.30	46.07	1.51	5.97	32.63	80.00	2.20
400.10	575.00	6.05	53.79	45.57	1.59	6.81	33.47	100.00	2.07
500.10	675.00	6.14	50.76	46.77	1.55	4.32	33.65	120.00	2.03
550.10	725.00	6.16	50.36	47.01	1.59	3.34	32.76	160.00	1.92
600.10	775.00	6.16	49.84	48.36	1.68	3.11	33.04	180.00	1.87
650.10	825.00	6.15	49.66	51.05	1.72	2.25	33.60	200.00	1.85
700.10	875.00	6.18	49.50	52.92	1.80	2.31	34.34	250.00	1.70
750.10	925.00	6.13	50.01	53.20	1.82	1.72	34.02	300.00	1.56
800.10	975.00	6.24	51.54	53.64	1.88	1.93	34.09	400.00	1.31
850.10	1025.00	6.18	53.99	54.13	1.89	1.94	34.21	500.00	1.28
870.10	1070.00	6.38	58.36	56.30	1.92	2.46	33.47	600.00	1.58
900.10	1070.00	6.39	58.36	56.30	1.93	2.46	33.87	700.00	1.94
950.10	1125.00	6.34	62.49	59.25	1.95	3.38	33.64	800.00	2.16
1000.10	1175.00	6.56	62.18	62.18	1.94	3.52	32.46	900.00	2.34

### electrical schematic

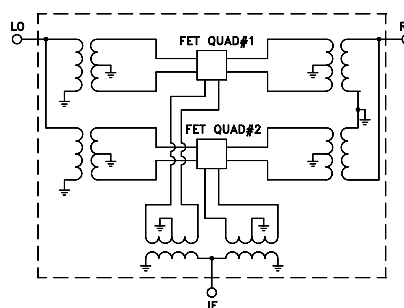

Distribution Centers NORTH AMERICA 800-654-7949 • 417-335-5935 • Fax 417-335-5945 • EUROPE 44-1252-832600 • Fax 44-1252-837010

Mini-Circuits ISO 9001 & ISO 14001 Certified

INTERNET <http://www.minicircuits.com>



REV. OR M97027 ED-11734/2 LAVI-10VH+ DJ/CP 060221 Page 1 of 3

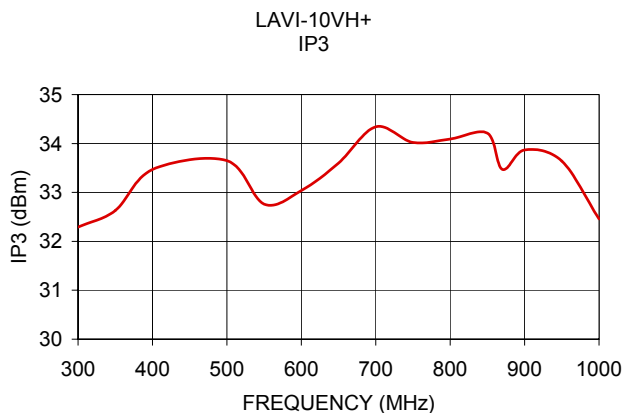
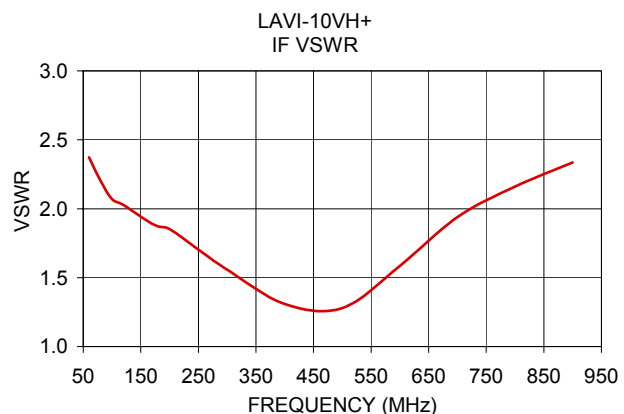
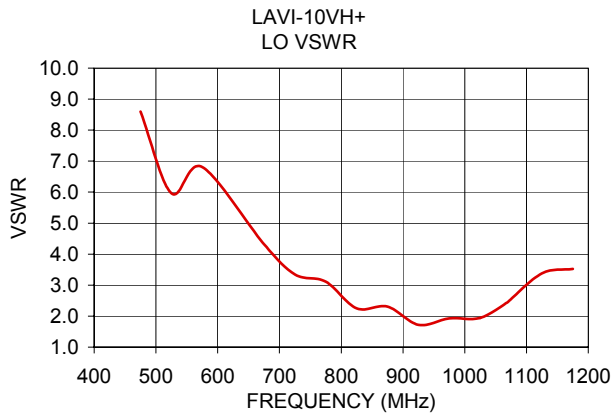
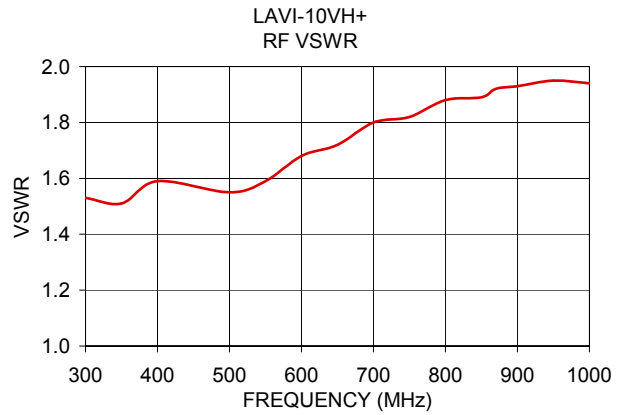
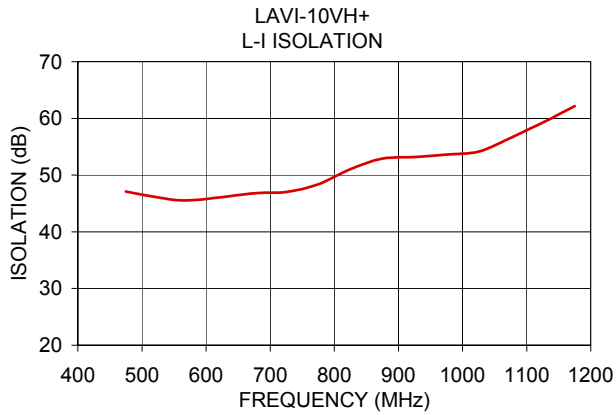
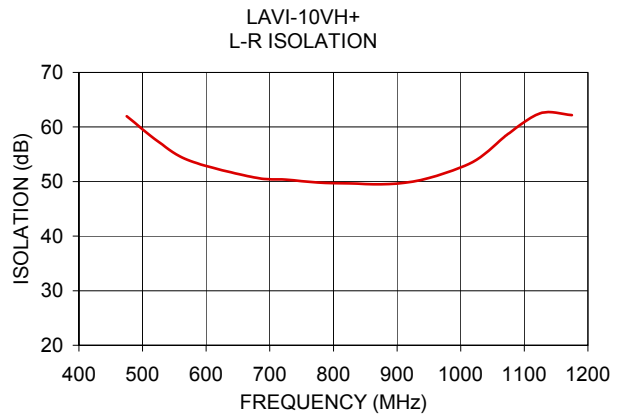
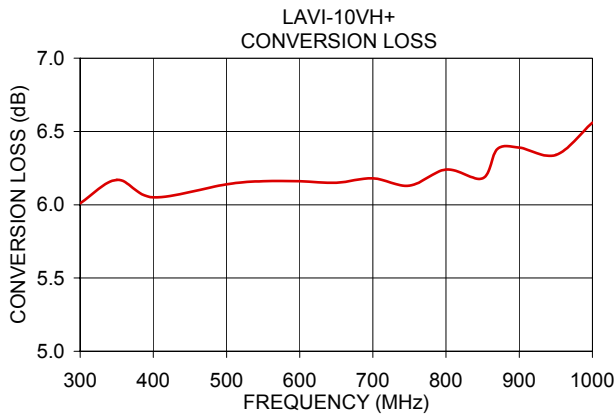

## Harmonic Table ( $T_{AMB} = 25^{\circ}\text{C}$ ) (Relative to desired IF output)

RF HARMONICS ORDER		RF CAL (-dBc)											
		0	1	2	3	4	5	6	7	8	9	10	
0	-	-	13	23	20	33	21	34	29	43	38	52	
1	-	32	0	37	14	40	26	56	42	55	54	60	
2	88	60	71	55	64	58	73	60	66	66	72	78	
3	96	95	72	90	70	91	72	96	76	92	80	102	
4	100	105	95	100	96	103	100	106	101	106	106	107	
5	97	105	104	101	104	96	100	102	103	104	104	107	
6	100	106	105	107	100	101	98	103	102	105	105	107	
7	100	109	109	104	104	100	101	98	101	105	105	108	
8	100	109	108	108	105	103	98	100	100	99	106	105	
9	101	108	108	106	105	106	102	104	100	104	102	107	
10	101	107	108	110	107	106	107	100	102	99	104	103	
		0	1	2	3	4	5	6	7	8	9	10	
LO HARMONICS ORDER													

Test conditions: RF IN: 650 MHz, 0 dBm.  
 LO IN: 822.5 MHz, 21 dBm.  
 IF OUT: 172.5 MHz  
 C. LOSS: 6.36 dB.