

CONDENSER MICROPHONE APPLICATION.

FEATURES

- Especially Suited for Use in Audio, Telephone.
- Capacitor Microphones.
- Excellent Voltage Characteristics.
- Excellent Transient Characteristics.

MAXIMUM RATING (Ta=25 °C)

CHARACTERISTIC	SYMBOL	RATING	UNIT
Gate-Drain Voltage	V_{GDO}	-20	V
Gate Current	I_G	10	mA
Drain Current	I_D	1	mA
Drain Power Dissipation	P_D	150	mW
Junction Temperature	T_j	150	°C
Storage Temperature Range	T_{stg}	-55 ~ 150	°C

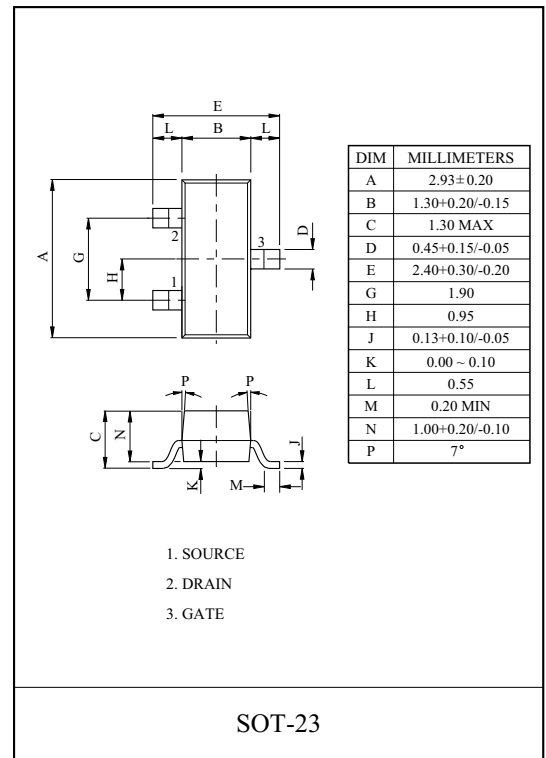

Marking

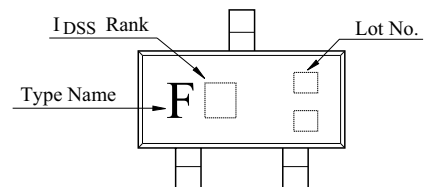

ELECTRICAL CHARACTERISTICS (Ta=25 °C)

CHARACTERISTIC	SYMBOL	TEST CONDITION	MIN.	TYP.	MAX.	UNIT
Gate-Drain Breakdown Voltage	$V_{(BR)GDO}$	$I_G = -100 \mu A$	-20	-	-	V
Gate-Source Cut-off Voltage	$V_{GS(OFF)}$	$V_{DS} = 5V, I_D = 1 \mu A$	-	-0.6	-1.5	V
Drain Current	I_{DSS} (Note)	$V_{DS} = 5V, V_{GS} = 0$	150	-	320	μA
Forward Transfer Admittance	$ y_{fs} $	$V_{DS} = 5V, V_{GS} = 0, f = 1kHz$	0.4	1.2	-	mS
Input Capacitance	C_{iss}	$V_{DS} = 5V, V_{GS} = 0, f = 1MHz$	-	3.5	-	pF
Reverse Transfer Capacitance	C_{rss}	$V_{DS} = 5V, V_{GS} = 0, f = 1MHz$	-	0.65	-	pF

Note : I_{DSS} Classification Y(1) : 150~240, GR(2) : 210~320

KTK596S

ELECTRICAL CHARACTERISTICS

($T_a=25^\circ\text{C}$, $V_{CC}=4.5\text{V}$, $R_L=1\text{k}\Omega$, $C_{in}=15\text{pF}$, See Specified Test Circuit.)

CHARACTERISTIC	SYMBOL	TEST CONDITION	MIN.	TYP.	MAX.	UNIT
Voltage Gain	G_V	$V_{in}=10\text{mV}$, $f=1\text{kHz}$	-	-3.0	-	dB
Reduced Voltage Characteristic	ΔG_{VV}	$V_{in}=10\text{mV}$, $f=1\text{kHz}$ $V_{CC}=4.5\text{V} \rightarrow 1.5\text{V}$	-	-1.2	-4.0	dB
Frequency Characteristic	ΔG_{VF}	$f=1\text{kHz} \sim 110\text{Hz}$	-	-	-1.0	dB
Input Resistance	Z_{in}	$f=1\text{kHz}$	25	-	-	$\text{M}\Omega$
Output Resistance	Z_O	$f=1\text{kHz}$	-	-	700	Ω
Total Harmonic Distortion	THD	$V_{in}=30\text{mV}$, $f=1\text{kHz}$	-	1.0	-	%
Output Noise Voltage	V_{NO}	$V_{in}=0$, A curve	-	-	-110	dB

SPECIFIED TEST CIRCUIT

- Voltage gain.
- Frequency Characteristic.
- Distortion.
- Reduced Voltage Characteristic.

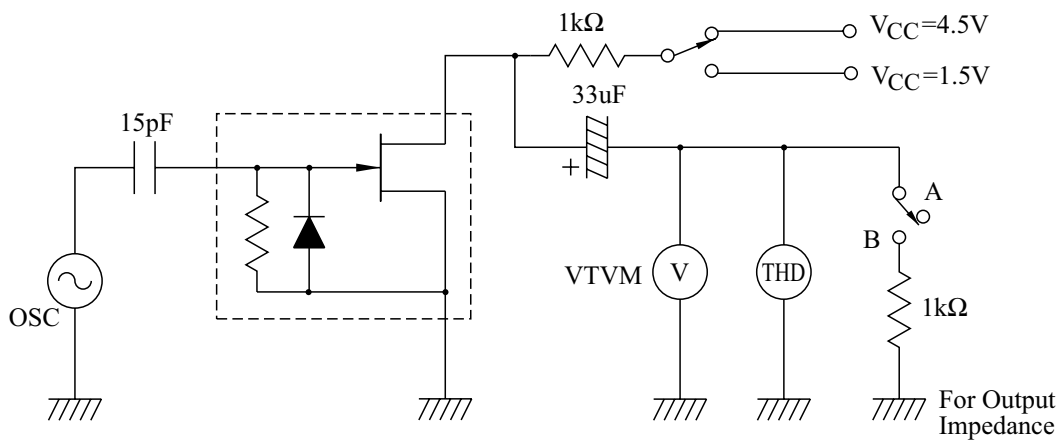

KTK596S

$I_D - V_{DS}$

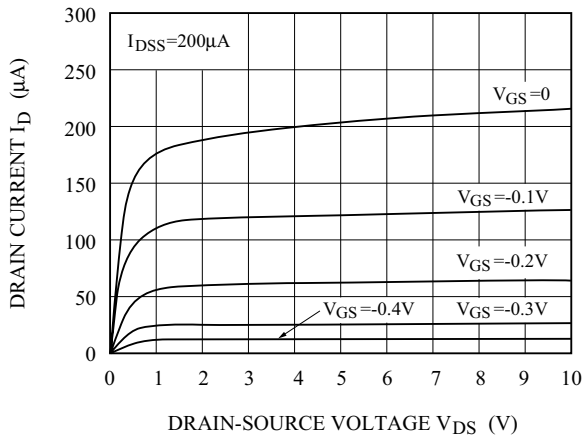

$I_D - V_{GS}$

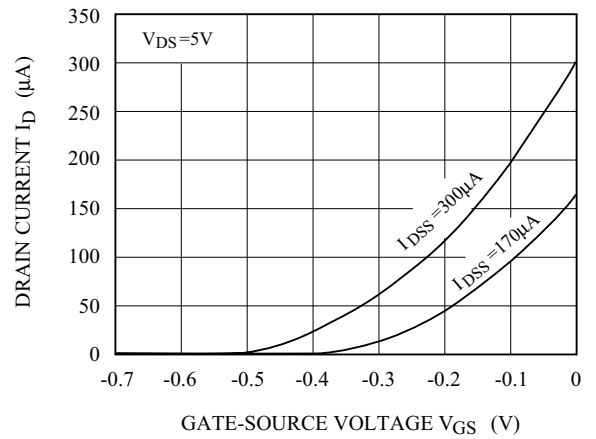

$|y_{fs}| - I_{DSS}$

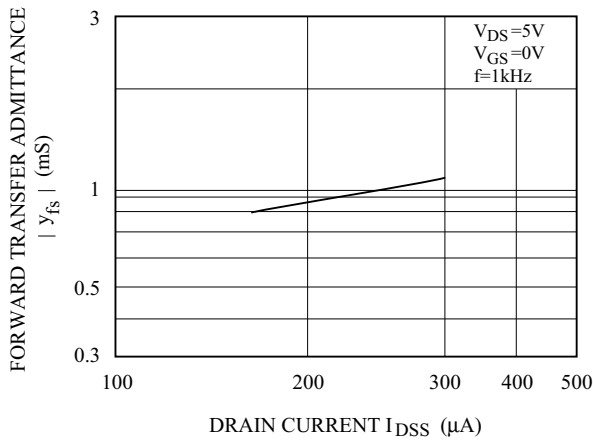

$V_{GS(off)} - I_{DSS}$

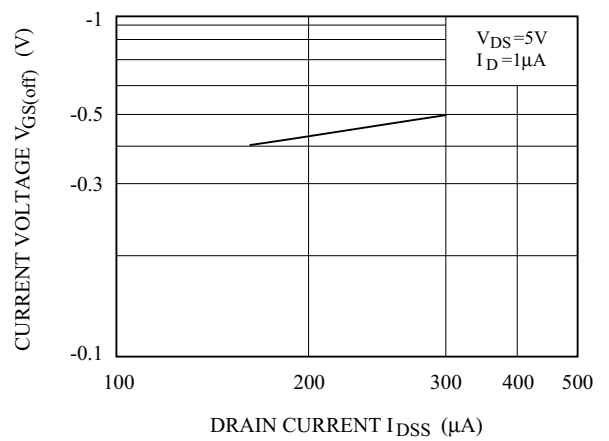

$C_{iss} - V_{DS}$

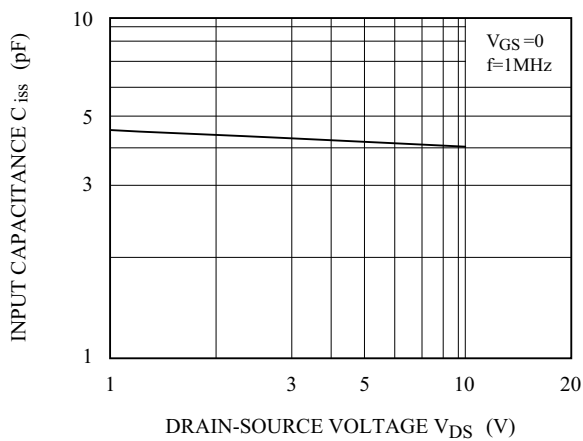

$C_{rss} - V_{DS}$

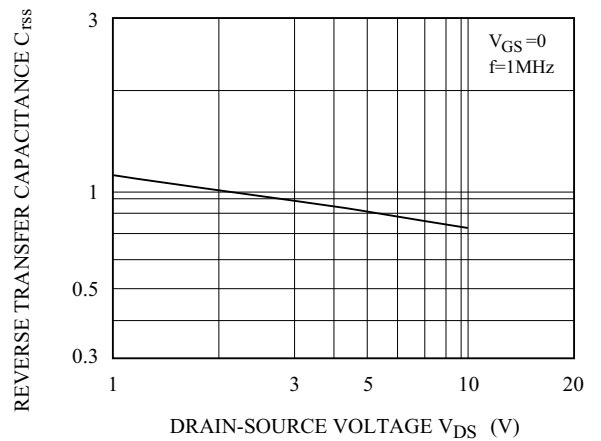

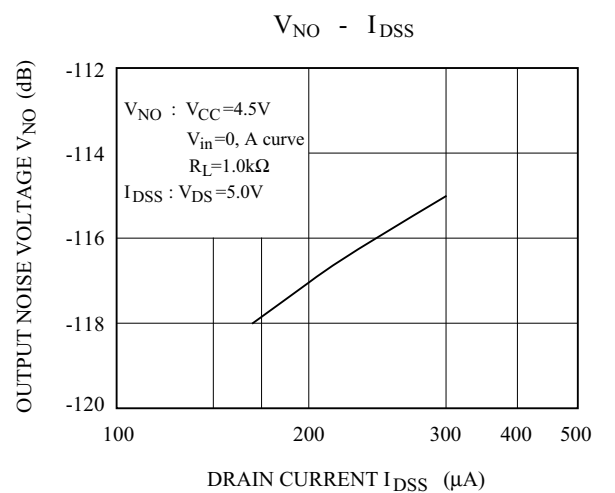
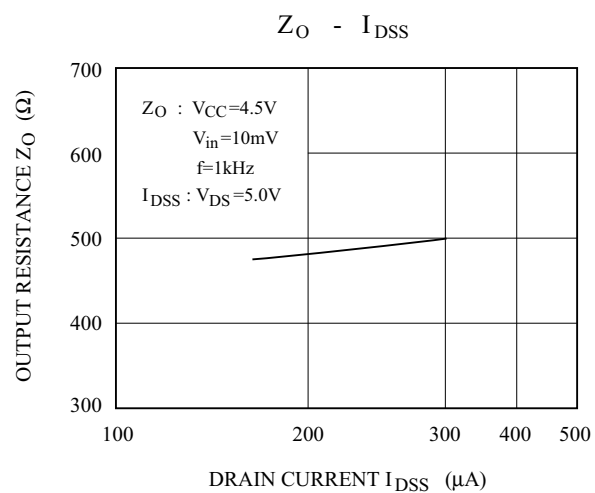
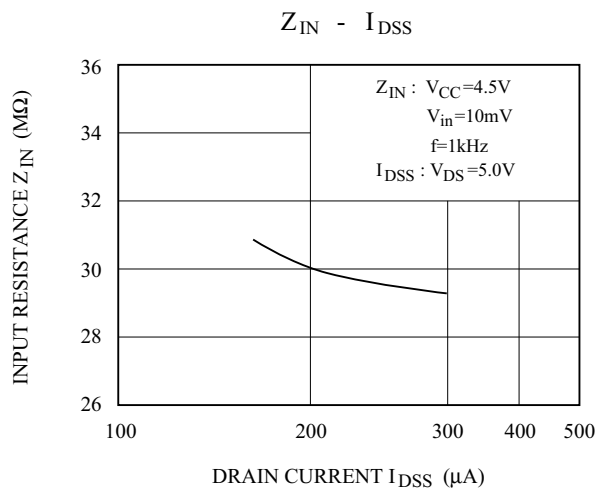
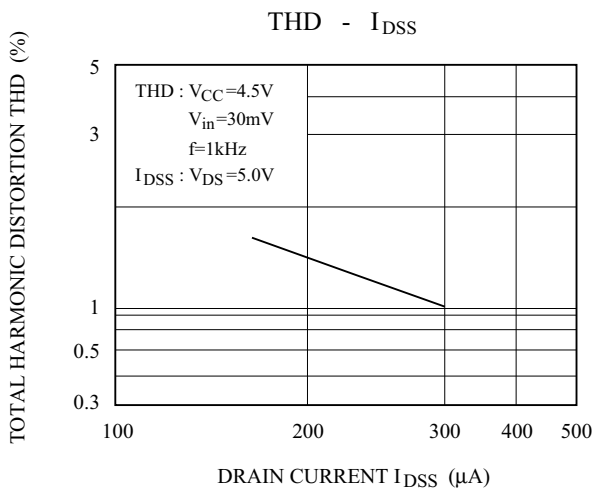
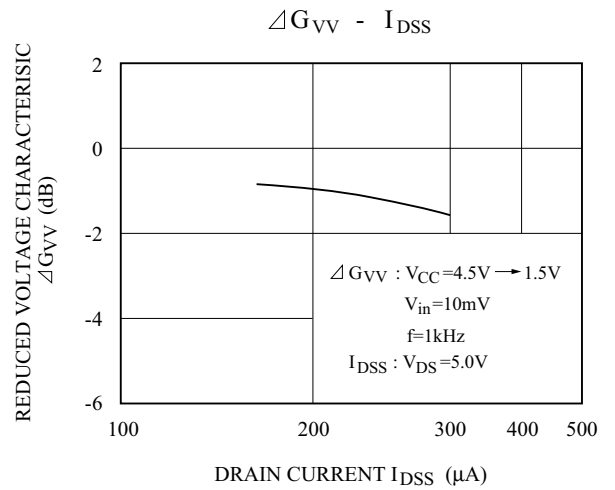
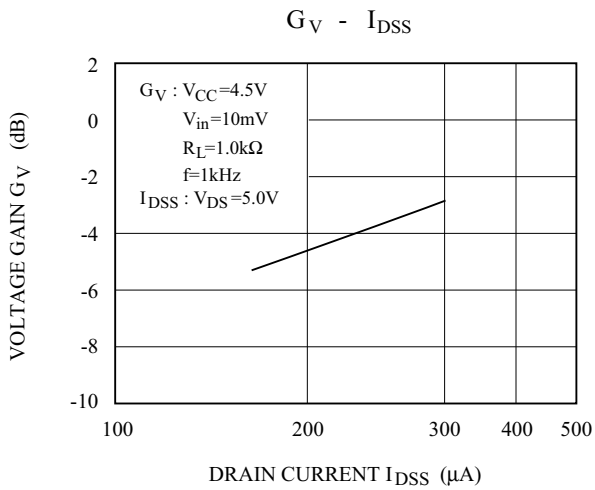

KTK596S

