

1. Marking method

Laser Marking or Ink Marking

2. Marking

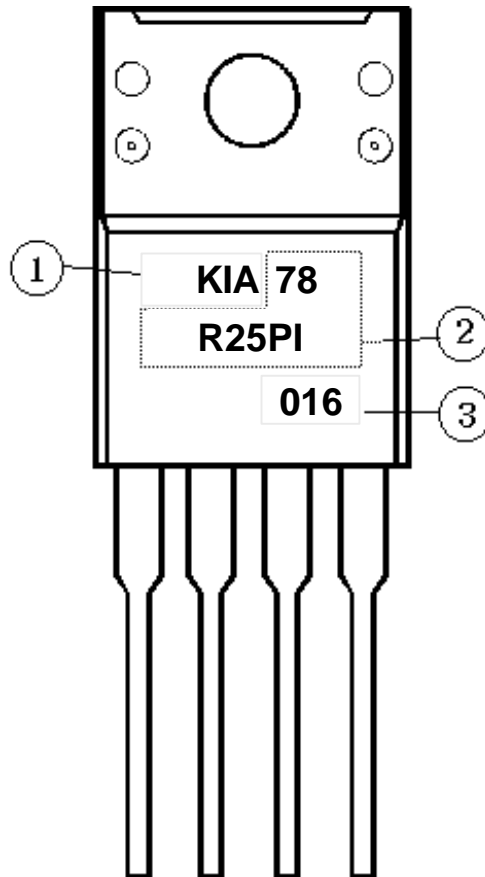

No.	Item	Marking	Description		
1	KEC	KIA	KEC ANALOG INTEGRATED CIRCUIT		
2	Device Name	78R25PI	KIA78R25PI		
3	Lot No.	016	0	Year	0 ~ 9 : 2000~2009
			16	Week	16 : 16th Week