

# Frequency/Rate Meter K3NR

## High-speed, Intelligent Interface Modules with Seven Operating Modes Convert Single or Dual Input Pulses to Display Values

- 50-kHz input range and 0.006% accuracy for sophisticated control.
- A wide selection of outputs: relay, transistor, BCD, linear, or communications.
- Maximum/Minimum value hold, set value write protection, and more.
- Banks with four comparative output values and four prescale values.
- Prescale function available, which displays in units of actual physical parameters (length, volume, etc.).
- Set value teaching, linear output range teaching, and prescale teaching are available using actual measured values.
- Displays values in hours, minutes, and seconds in operating mode 6.
- A startup compensation time parameter keeps the measurement operation from sending an unnecessary output for a preset period up to 99.9 s.
- Built-in sensor power supply (12 VDC, 80 mA).
- Compact 1/8 DIN size.
- Conforms to EMC standards, EN61010-1 (IEC61010-1).
- UL/CSA approved.



## Model Number Structure

### Model Number Legend

Base Units and Output Boards can be ordered individually or as sets. Refer to the *Output Board Combinations* table on page 130.

#### Base Units

K3NR -      
1 2 3 4

#### 1, 2. Input Sensors Codes

- NB: NPN inputs/Voltage pulse inputs
- PB: PNP inputs

#### 3. Supply Voltage

- 1: 100 to 240 VAC
- 2: 12 to 24 VDC

#### 4. Display

- A: Basic
- C: Set Value LED Display

#### 5, 6, 7, 8. Output Type Codes

- C1: 3 comparative relay contact outputs (H, PASS, L: SPDT)
- C2: 5 comparative relay contact outputs (HH, H, L, LL: SPST-NO; PASS: SPDT)
- C5: 5 comparative relay contact outputs (HH, H, L, LL: SPST-NC; PASS: SPDT)
- T1: 5 comparative transistor outputs (NPN open collector)
- T2: 5 comparative transistor outputs (PNP open collector)
- B2: BCD output (NPN open collector) (see note)
- B4: BCD output + 5 transistor outputs (NPN open collector)
- L1: Linear output (4 to 20 mA) (see note)

**Note:** These output types are available on Basic Models only.

#### Output Boards

K31 -      
5 6 7 8



#### Base Units with Output Boards

K3NR -     -      
1 2 3 4 5 6 7 8

- L2: Linear output (1 to 5 VDC) (see note)
- L3: Linear output (1 mV/10 digits) (see note)
- L4: Linear output, 4 to 20 mA + 5 transistor outputs (NPN open collector)
- L5: Linear output, 1 to 5 V + 5 transistor outputs (NPN open collector)
- L6: Linear output, 1 mV/10 digits+ 5 transistor outputs (NPN open collector)
- L7: Linear output, 0 to 5 VDC (see note)
- L8: Linear output, 0 to 10 VDC (see note)
- L9: Linear output, 0 to 5 VDC + 5 transistor outputs (NPN open collector)
- L10: Linear output, 0 to 10 VDC + 5 transistor outputs (NPN open collector)
- FLK1: Communication RS-232C (see note)
- FLK2: Communication RS-485 (see note)
- FLK3: Communication RS-422 (see note)
- FLK4: RS-232C + 5 transistor outputs (NPN open collector)
- FLK5: RS-485 + 5 transistor outputs (NPN open collector)
- FLK6: RS-422 + 5 transistor outputs (NPN open collector)

# Ordering Information

## ■ Base Unit

Input type	NPN/Voltage pulse		PNP	
	100 to 240 VAC	12 to 24 VDC	100 to 240 VAC	12 to 24 VDC
<b>Basic Models</b> These models provide a present value LED and front-panel control keys. Can be connected to any Output Board, or can be used for display only without an Output Board. 	K3NR-NB1A	K3NR-NB2A	K3NR-PB1A	K3NR-PB2A
<b>Set Value LED Models</b> These models provide a present value LED, set value LED, and front-panel control keys. Can be connected to Relay, Transistor, or Combination Output Boards. 	K3NR-NB1C	K3NR-NB2C	K3NR-PB1C	K3NR-PB2C

## ■ Available Output Board Combinations

Output type	Output configuration	Output boards	Base units	
			Basic	Set Value LED Display
Relay contact	3 outputs: H, PASS, L (SPDT)	K31-C1	Yes	Yes
	5 outputs: HH, H, L, LL (SPST-NO), and PASS (SPDT)	K31-C2	Yes	Yes
	5 outputs: HH, H, L, LL (SPST-NC), and PASS (SPDT)	K31-C5	Yes	Yes
Transistor	5 outputs (NPN open collector)	K31-T1	Yes	Yes
	5 outputs (PNP open collector)	K31-T2	Yes	Yes
BCD (see note)	5-digit output (NPN open collector)	K31-B2	Yes	---
Linear	4 to 20 mA DC	K31-L1	Yes	---
	1 to 5 VDC	K31-L2	Yes	---
	1 mV/10 digits	K31-L3	Yes	---
	0 to 5 VDC	K31-L7	Yes	---
	0 to 10 VDC	K31-L8	Yes	---
Communication boards (see note)	RS-232C	K31-FLK1	Yes	---
	RS-485	K31-FLK2	Yes	---
	RS-422	K31-FLK3	Yes	---
Combination output and communication boards	BCD output + 5 transistor outputs (NPN open collector)	K31-B4	Yes	Yes
	4 to 20 mA + 5 transistor outputs (NPN open collector)	K31-L4	Yes	Yes
	1 to 5 V + 5 transistor outputs (NPN open collector)	K31-L5	Yes	Yes
	1 mV/10 digits + 5 transistor outputs (NPN open collector)	K31-L6	Yes	Yes
	0 to 5 VDC + 5 transistor outputs (NPN open collector)	K31-L9	Yes	Yes
	0 to 10 VDC + 5 transistor outputs (NPN open collector)	K31-L10	Yes	Yes
	RS-232C + 5 transistor outputs (NPN open collector)	K31-FLK4	Yes	Yes
	RS-485 + 5 transistor outputs (NPN open collector)	K31-FLK5	Yes	Yes
RS-422 + 5 transistor outputs (NPN open collector)	K31-FLK6	Yes	Yes	

**Note:** For details, refer to the *Communication Operation Manual*.

# Specifications

## ■ Ratings

<b>Supply voltage</b>	100 to 240 VAC (50/60 Hz); 12 to 24 VDC
<b>Operating voltage range</b>	85% to 110% of supply voltage
<b>Power consumption (see note)</b>	15 VA max. (max. AC load with all indicators lit) 10 W max. (max. DC load with all indicators lit)
<b>Sensor power supply</b>	80 mA at 12 VDC±10%
<b>Insulation resistance</b>	20 MΩ min. (at 500 VDC) between external terminal and case. Insulation provided between inputs, outputs, and power supply.
<b>Dielectric strength</b>	2,000 VAC for 1 min between external terminal and case. Insulation provided between inputs, outputs, and power supply.
<b>Noise immunity</b>	±1,500 V on power supply terminals in normal or common mode ±1 μs, 100 ns for square-wave noise with 1 ns
<b>Vibration resistance</b>	Malfunction: 10 to 55 Hz, 0.5-mm for 10 min each in X, Y, and Z directions Destruction: 10 to 55 Hz, 0.75-mm for 2 hrs each in X, Y, and Z directions
<b>Shock resistance</b>	Malfunction: 98 m/s <sup>2</sup> for 3 times each in X, Y, and Z directions Destruction: 294 m/s <sup>2</sup> for 3 times each in X, Y, and Z directions
<b>Ambient temperature</b>	Operating: -10°C to 55°C (with no icing) Storage: -20°C to 65°C (with no icing)
<b>Ambient humidity</b>	Operating: 25% to 85% (with no condensation)
<b>EMC</b>	(EMI) EN61326+A1 Industry Emission Enclosure: CISPR 11 Group 1 class A: CISRP16-1/-2 Emission AC Mains: CISPR 11 Group 1 class A: CISRP16-1/-2 (EMS) EN61326+A1 Industry Immunity ESD: EN61000-4-2: 4 kV contact discharge (level 2) 8 kV air discharge (level 3) Immunity RF-interference: EN61000-4-3: 10 V/m (amplitude-modulated, 80 MHz to 1 GHz) (level 3) Immunity Fast Transient Noise: EN61000-4-4: 2 kV (power line) (level 3) Immunity Burst Noise: 1 kV line to line (I/O signal line) Immunity Surge: EN61000-4-5: 1 kV line to line 2 kV line to ground (power line) Immunity Conducted Disturbance EN61000-4-6: 3 V (0.15 to 80 MHz) (level 2) Immunity Voltage Dip/Interrupting EN61000-4-11: 0.5 cycles, 0, 180°, 100% (rated voltage)
<b>Approved standards</b>	UL508, CSA22.2; Conforms to EN61326+A1, EN61010-1 (IEC61010-1) Conforms to VDE0106/P100 (finger protection) when the terminal cover is mounted.
<b>Weight</b>	Approx. 400 g

**Note:** A K3NR with DC supply voltage requires approximately 1 A DC as control power supply current the moment the K3NR is turned ON. Do not forget to take this into consideration when using several K3NR units. When the K3NR is not in measuring operation (e.g., the K3NR has been just turned ON or is operating for startup compensation time), the display will read "00000" and all outputs will be OFF.

## ■ Characteristics

<b>Input signal</b>	No-voltage contact (30 Hz max., ON/OFF pulse width: 15 ms min.) Voltage pulse (50 kHz max., ON/OFF pulse width: 9 μs min., ON voltage: 4.5 to 30 V/OFF voltage: -30 to 2 V) Open collector (50 kHz max., ON/OFF pulse width: 9 μs min.) <b>Connectable Sensors</b> ON residual voltage: 3 V max. OFF leakage current: 1.5 mA max. Load current: Must have switching capacity of 20 mA min. Must be able to dependably switch a load current of 5 mA max.
<b>Measuring accuracy (at 23±5°C)</b>	Operating modes 1 and 6: ±0.006%rdg±1 digit Operating modes 2 to 5: ±0.02%rdg±1 digit
<b>Measuring modes and ranges (Operating modes 1 to 6 are for no-contact sensor models)</b>	Operating mode 1: Rotational/circumferential speed 0.0005 to 50,000 Hz Operating mode 2: Absolute ratio 0.0005 to 50,000 Hz Operating mode 3: Error ratio 0.0005 to 50,000 Hz Operating mode 4: Rotational difference 0.0005 to 50,000 Hz Operating mode 5: Flow rate ratio 0.0005 to 50,000 Hz Operating mode 6: Passing time 0.0005 to 50,000 Hz Operating mode 7: Pulse counting 0 to 4G count (32-bit counter)
<b>Max. displayed digits</b>	5 digits (-19999 to 99999)
<b>Display</b>	7-segment LED
<b>Polarity display</b>	"-" is displayed automatically with a negative input signal.
<b>Zero display</b>	Leading zeros are not displayed.
<b>Prescale function</b>	Programming via front-panel key inputs. (0.0001 x 10 <sup>-9</sup> to 9.9999 x 10 <sup>9</sup> , decimal point can be set freely) Can be set using prescale value teaching.
<b>HOLD functions (see note 2)</b>	Max. value (peak) hold, Min. value (bottom) hold
<b>External control</b>	HOLD (Process value held) RESET (Maximum/minimum data reset, counting value reset) BANK (Selection of one bank out of 4 banks of set values) (Selection of one bank out of 4 banks of prescale values)
<b>Comparative output hysteresis setting</b>	Programmable with front-panel key inputs (1 to 9999).
<b>Other functions</b>	Variable linear output range (for models with linear outputs only) (note 1) Remote/Local processing (available for communications output models only) Maximum/Minimum value data reset with front panel keys Comparative output pattern selection Process time for averaging measured values Startup compensation time (0.0 to 99.9 s) Time unit display Security Memory power failure
<b>Output configuration</b>	Relay contact output (3 or 5 outputs) Transistor output (NPN and PNP open collector), BCD (NPN open collector) Parallel BCD (NPN open collector) + transistor output (NPN open collector) Linear output (4 to 20 mA, 1 to 5 V) + transistor output (NPN open collector) Communication functions (RS-232C, RS-485, RS-422) Communication functions (RS-232C, RS-485, RS-422) + transistor output (NPN open collector)
<b>Delay in comparative outputs (at transistor output)</b>	Operating modes 1 to 6: 200 ms max. Operating mode 7: 1 ms max.
<b>Linear output response time</b>	Operating modes 1 to 6: 220 ms max. Operating mode 7: 20 ms max.
<b>Degree of protection</b>	Front panel: NEMA4X for indoor use (equivalent to IP66) Rear case: IEC standard IP20 Terminals: IEC standard IP00
<b>Memory protection</b>	Non-volatile memory (EEPROM) (possible to rewrite 100,000 times)

- Note:** 1. The linear output range cannot be set when connected to a 1 mV/10-digit Linear Output Board.  
2. Not effective for operating mode 7.

## Input/Output Ratings

### Relay Contact Output

(Incorporating a G6B Relay)

Item	Resistive load (cos $\phi$ = 1)	Inductive load (cos $\phi$ = 0.4, L/R = 7 ms)
Rated load	5 A at 250 VAC; 5 A at 30 VDC	1.5 A at 250 VAC, 1.5 A at 30 VDC
Rated carry current	5 A max. (at COM terminal)	
Max. contact voltage	380 VAC, 125 VDC	
Max. contact current	5 A max. (at COM terminal)	
Max. switching capacity	1,250 VA, 150 W	375 VA, 80 W
Min. permissible load (P level, reference value)	10 mA at 5 VDC	
Mechanical life	50,000,000 times min. (at a switching frequency of 18,000 times/hr)	
Electrical life (at an ambient temperature of 23°C)	100,000 times min. (at a rated load switching frequency of 1,800 times/hr)	

### Transistor Output

Rated load voltage	24 VDC max.
Max. load current	50 mA
Leakage current	100 $\mu$ A max.

### BCD Output

I/O signal name		Item	Rating
Inputs	REQUEST, HOLD, MAX, MIN, RESET	Input signal	No-voltage contact input
		Input current with no-voltage input	10 mA
		Signal level	ON voltage: 1.5 V max. OFF voltage: 3 V min.
Outputs	DATA, POLARITY, OVERFLOW, DATA VALID, RUN	Rated load voltage	24 VDC max.
		Max. load current	10 mA
		Leakage current	100 $\mu$ A max.

Note: Logic method: negative logic

### Linear Output

Item	4 to 20 mA	1 to 5 V	1 mV/10 digits (see note)
Resolution	4,096		
Output error	$\pm$ 0.5% FS		$\pm$ 1.5% FS
Permissible load resistance	600 $\Omega$ max.	500 $\Omega$ min.	1 K $\Omega$ min.

Note: For the 1 mV/10-digit output, the output voltage changes for every 40 to 50 increment in the display value.

## Communications Specifications

Item		RS-232C, RS-422	RS-485
Transmission method		4-wire, half-duplex	2-wire, half-duplex
Synchronization method		Start-stop synchronization	
Baud rate		1,200/2,400/4,800/9,600/19,200/38,400 bps	
Transmission code		ASCII (7-bit)	
Communications	Write	Comparative set value, prescaling value, remote/local programming, reset control of maximum/minimum values, and other setting mode items excluding communications conditions.	
	Read	Process value, comparative set value, maximum value, minimum value, model data, error code, and others	

For details, refer to *Communication Operation Manual*.

# Connections

## Terminal Arrangement

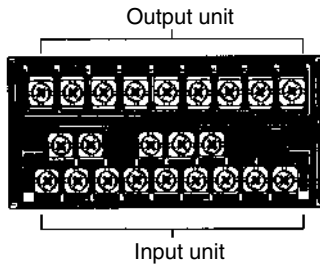

### Terminal Numbers

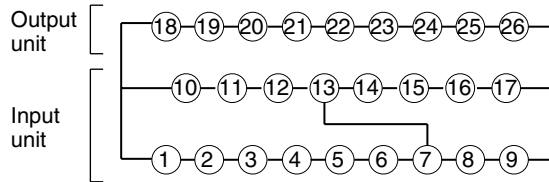

**Note:** Terminals 7 to 13 are connected internally.  
Terminals 7 and 11 are mutually isolated.

## Input Unit

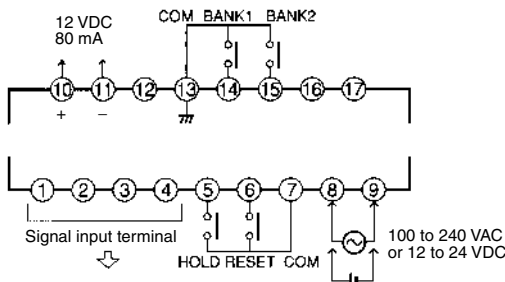

**Note:** Check the power supply specifications of the model used before connecting the power supply.

When inputting the external control signals and input signals through the open collector:

Transistor Inputs:

ON: Residual voltage must be 3 V max.

OFF: Leakage current must be 1.5 mA max.

The switching capacity must be 20 mA or greater.

When the external signal input is short-circuited, a voltage of approximately 5 V will be applied to between the terminals 5 to 7 and the COM terminal, and a current of approximately 18 mA (nominal value) will flow.

### NPN Inputs

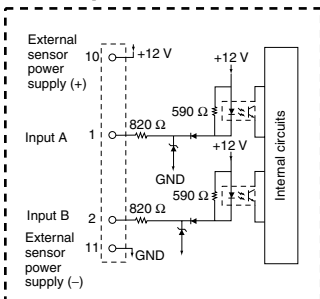

### Voltage Pulse Inputs

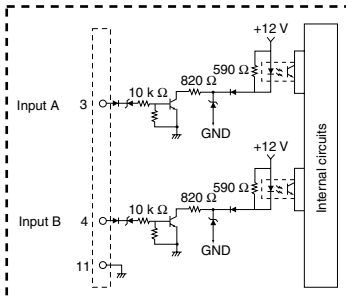

### PNP-Inputs

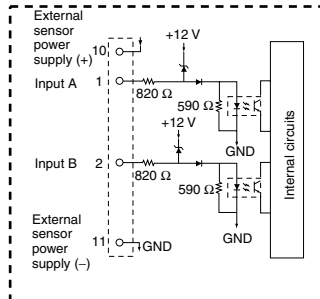

## K3NR-NB

### (NPN Input/Voltage Pulse Input)

#### NPN Open Collector Output (NPN Linear 2-wire Output)

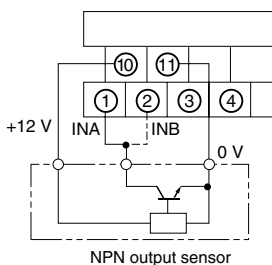

**Note:** Connect the + side of the NPN linear 2-wire input to terminal 1 and the - side to terminal 11.

#### Contact Output

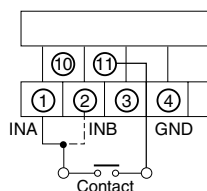

**Note:** When the contact is short-circuited, a current of approximately 13 mA will flow at a voltage of approximately 12 V.

#### Voltage Output

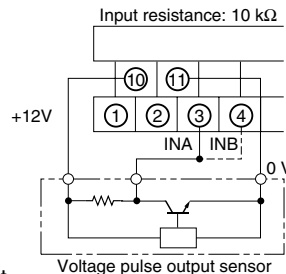

**Note:** With voltage pulse input not from a 3-wire sensor, connect the + side to terminal 3 and the - side to terminal 11.

## K3NR-PB (PNP Input)

#### PNP Open Collector Output

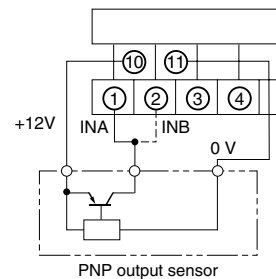

# Output Units

## K31-C1: Relay (3 Outputs)

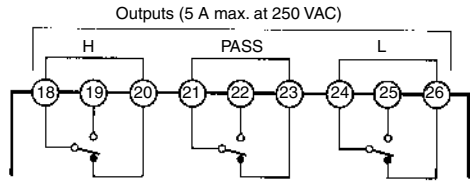

## K31-C2: Relay (5 Outputs)

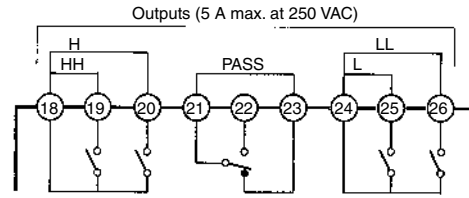

## K31-C5: Relay (5 Outputs)

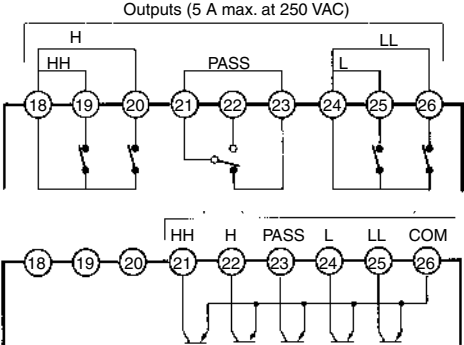

## K31-T1: Transistor (NPN Open Collector)

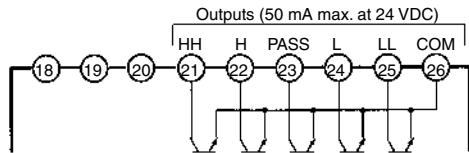

## K31-L1, L2, L3, L4, L5, L6, L7, L8, L9, L10: Linear

(Terminals 21 to 26 are provided only on K31-L4, L5, L6, L9, L10.)

- L1, L4: 4 to 20 mA
- L2, L5: 1 to 5 V
- L3, L6: 1 mV/10 digit
- L7, L9: 0 to 5 VDC
- L8, L10: 0 to 10 VDC

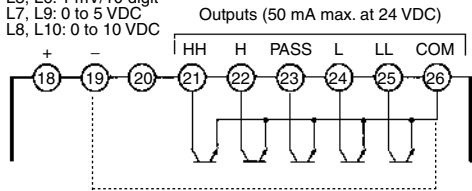

**Note:** With K31-L4/-L5/-L6/-L9/-L10 models, terminals 19 and 26 are connected internally.

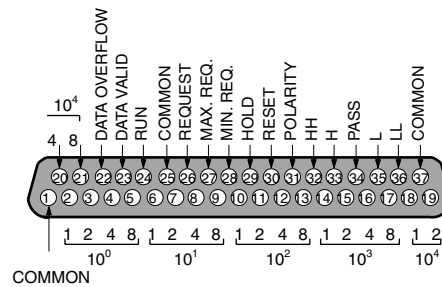

## K31-FLK1: RS-232C

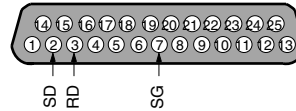

## K31-FLK2, -FLK5: RS-485

(Terminals 21 to 26 are provided only on K31-FLK5.)

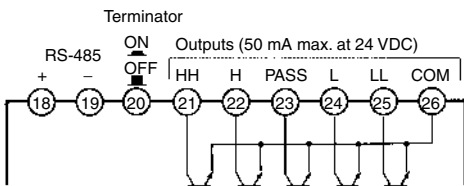

## K31-FLK3, -FLK6: RS-422

(The right connector is provided only on K31-FLK6)

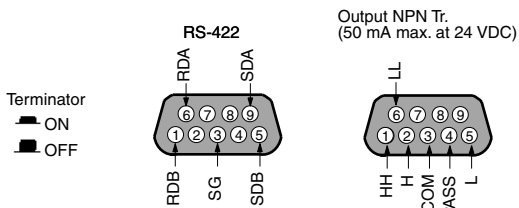

## K31-FLK4: RS-232C + Transistor (NPN Open Collector)

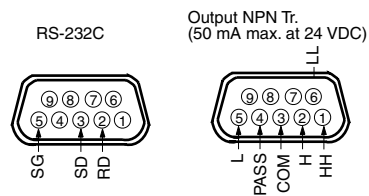

- D-sub 37P Connectors for BCD output (attachment)  
Plug: XM2A-3701  
Hood: XM2S-3711
- D-sub 25P connectors for RS-232C output (K31-FLK1) (order separately)  
Plug: XM2A-2501  
Hood: XM2S-2511
- D-sub 9P connectors for RS-422 output (K31-FLK3 and K31-FLK6) (order separately)  
Plug: XM2A-0901  
Hood: XM2S-0911
- D-sub 9P connectors for RS-232C output (K31-FLK4) (order separately)  
Plug: XM2D-0901  
Hood: XM2D-0911

■ Block Diagram

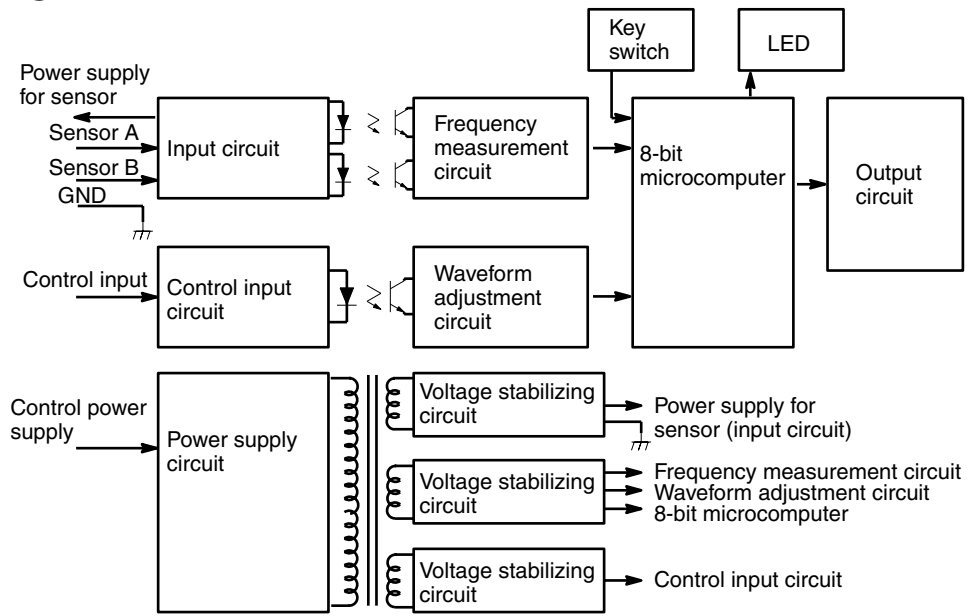



# Operation

## ■ Main Functions

### Output Pattern Selection $\overline{C-OUT}$

The patterns of comparative output are selectable according to the level change. Select the pattern according to the application.

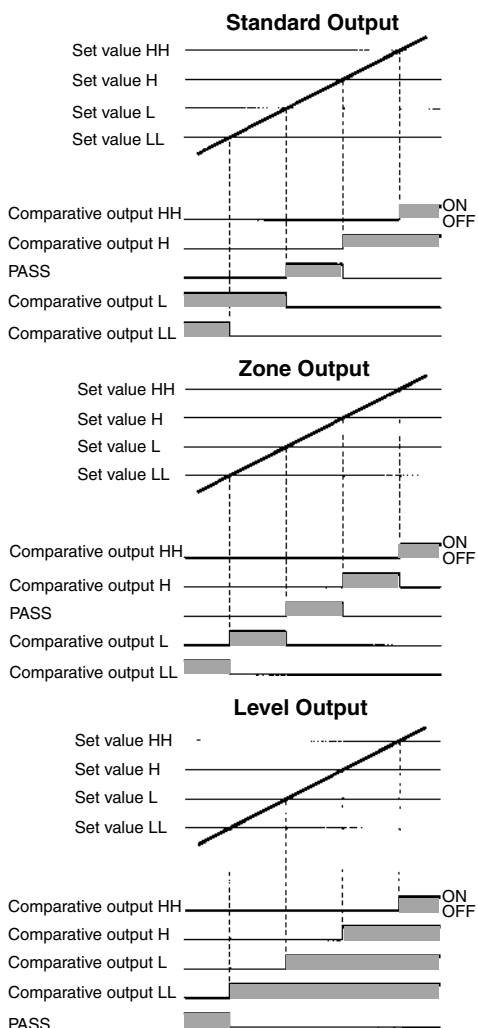

**Note:** The following setting conditions must be satisfied, otherwise no zone output will turn ON correctly.  
 $LL < L < H < HH$

### Startup Compensation Time $\overline{SCLNE}$

The startup compensation time parameter keeps the measurement operation from sending an unnecessary output corresponding to instantaneous, fluctuating input from the moment the K3NR is turned ON until the end of the preset period.

The compensation time can be set in a range from 0.0 to 99.9 seconds as the waiting time until the devices subject to measurement become stable after the startup of the power supply.

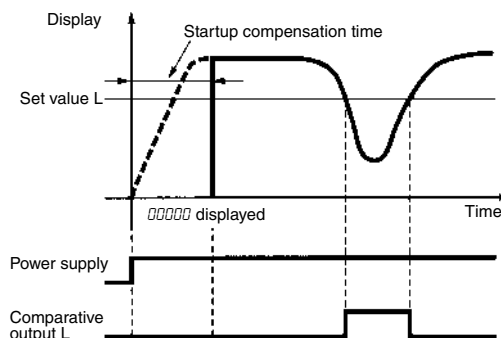

### Hysteresis $\overline{HYS}$

The hysteresis of comparative outputs can be set to prevent the chattering of comparative outputs. Refer to page 152 for more details.

### Linear Output Range $\overline{LSEL}$

A linear output range can be set as required. A value corresponding to the maximum output value and that corresponding to the minimum output value can be set.

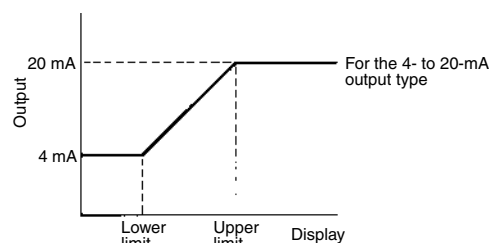

### Remote/Local Selection $\overline{r-L}$

Select remote programming when performing all settings through the host devices and select local programming when performing settings through key operation.

### Process Time for Averaging Measured Value

Process time for averaging measured value is the time over which the measured values will be averaged. If this time is shorter than the input pulse interval, processing will be based on the input pulse interval.

## ■ BCD Output Timing Chart

A request signal from an external device (such as a Programmable Controller) is required to read BCD data.

### Single Sampling Data Output

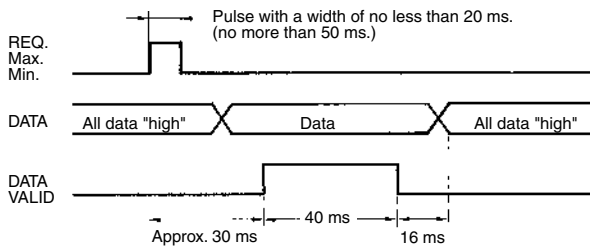

Approximately 30 ms after the REQ signal rises, a sample is taken and the DATA VALID signal is output. Read the data when the DATA VALID signal is ON.

The DATA VALID signal will turn OFF in 40 ms, and then in 16 ms, the data will go OFF.

Models with a BCD output have an open collector output configuration so that wired-OR connection is possible.

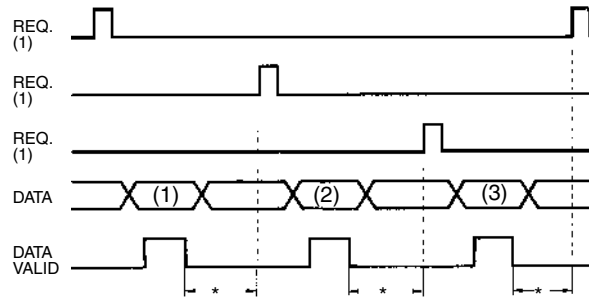
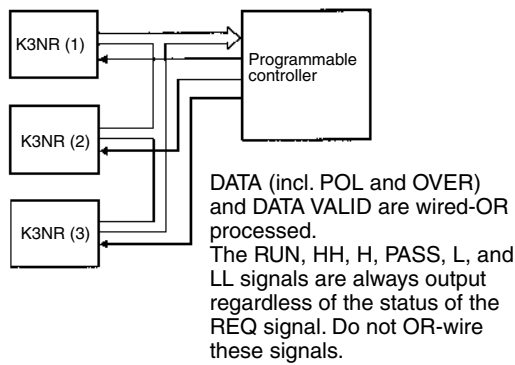

\*The period between the DATA VALID signal and the REQ signal should be no less than 20 ms max.

### Continuous Data Output

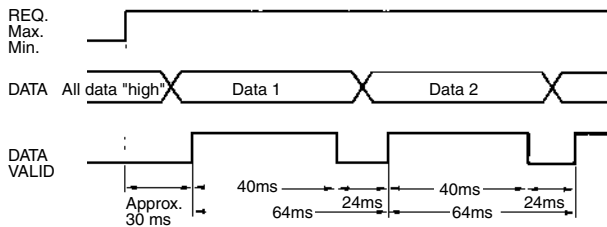

The K3NR outputs each measurement at an interval of 64 ms when a REQ signal is ON continuously.

If the HOLD signal is ON at the moment the DATA output is switched from Data 1 to Data 2 or vice versa, the output BCD data will be either Data 1 or Data 2 according to the timing of the HOLD signal. However, output data will never be below.

### Example of Connection to Programmable Controller

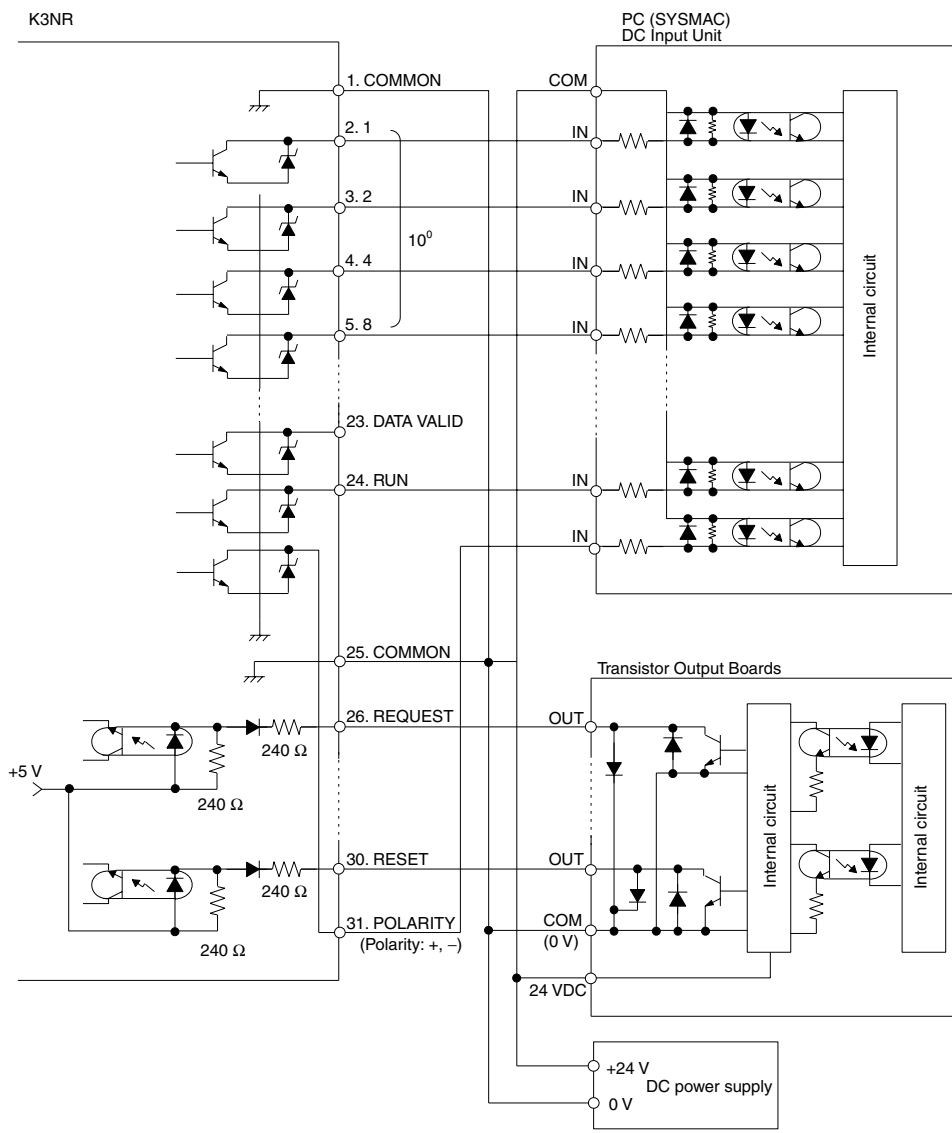

### Example of Connection to Display Unit

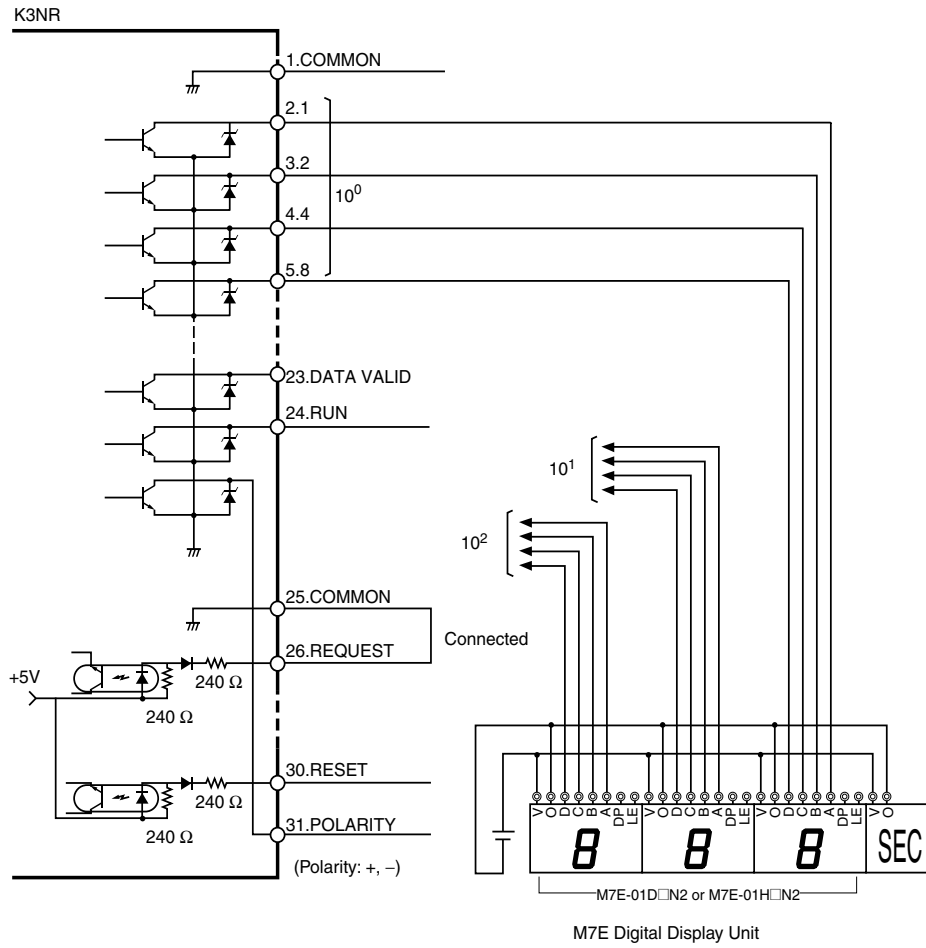

# Nomenclature

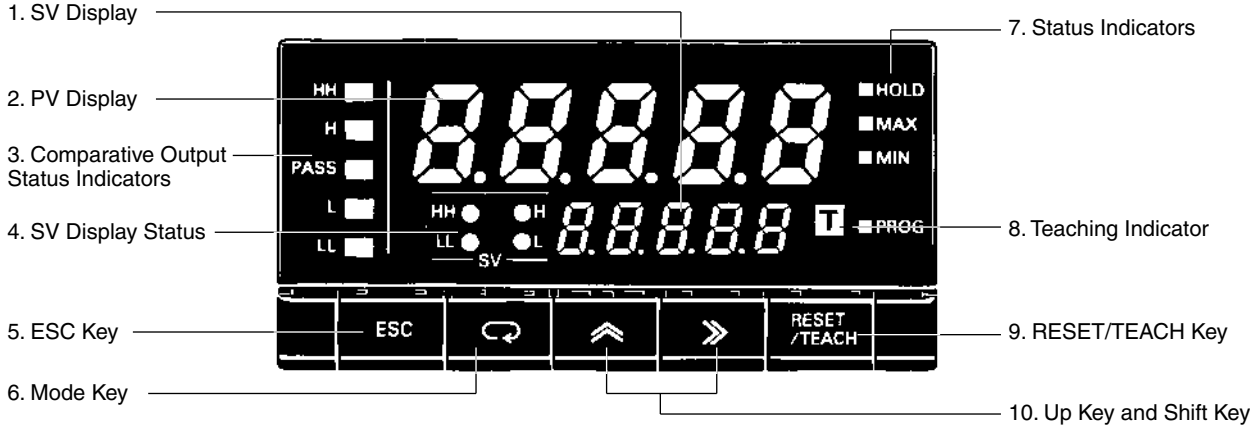

Name	Functions
<b>1. SV display</b>	Displays the set value or parameter. Available for Set Value LED Models only.
<b>2. PV display</b>	Displays the process value in addition to the max./min. value or parameter.
<b>3. Comparative output status indicators</b>	Displays the status of comparative output.
<b>4. SV display status</b>	Indicates which comparative set value is currently on the SV display.
<b>5. ESC Key</b>	Used to return to the RUN mode from the Setting, Protect, or Maintenance mode. The process value, maximum value, or minimum value to be displayed can be selected.
<b>6. Mode Key</b>	Used to enter the Setting mode. Used to allow the PV display to indicate set values sequentially. Available for Basic Models only. Used to indicate set values sequentially on the SV display. Available for Set Value LED Models only.
<b>7. Status indicators</b>	HOLD: Lit when HOLD input is ON. MAX: Lit when the maximum value is indicated on the PV display. MIN: Lit when the minimum value is indicated on the PV display. PROG: Lit or flashes while parameters are being set.
<b>8. Teaching indicator</b>	Lit when the teaching function is enabled and flashes when the K3NR is in teaching operation.
<b>9. RESET/TEACH Key</b>	The maximum value, minimum value, and counting values are reset by pressing this key. Teaching is available when the teaching function is enabled.
<b>10. Up Key and Shift Key</b>	The digit being set is scrolled by pressing the Shift Key. The set value increases by one whenever the Up Key is pressed.

Panel indicators

# Engineering Data

---

## Derating Curve for Sensor Power Supply

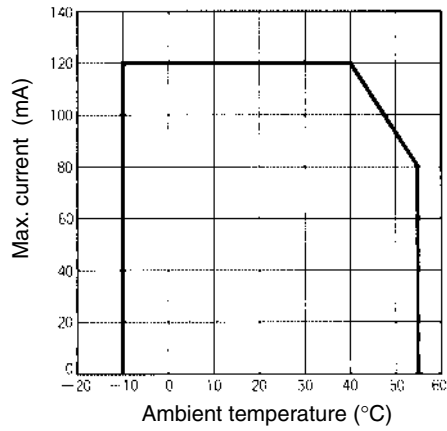

**Note:** The derating curve shown is for standard installation.  
The derating curve depends on the mounting direction.

# Dimensions

Note: All units are in millimeters unless otherwise indicated.

## PV Display

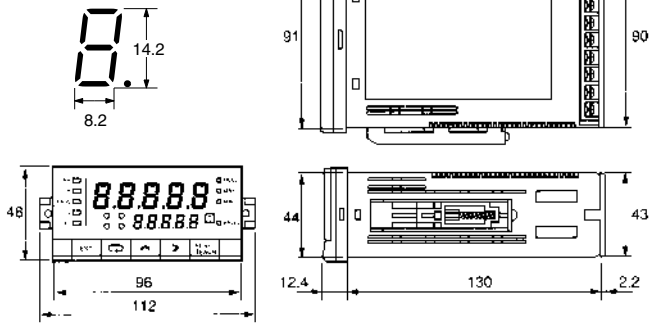

Note: The K3NR uses M3.5 terminals.  
A terminal cover is provided.

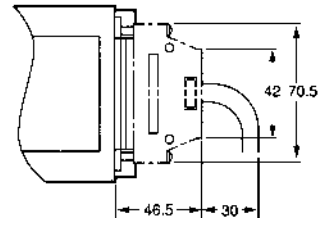

## Panel Cutouts

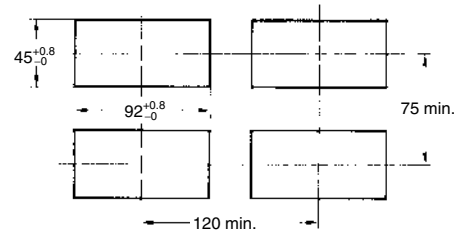

## Precautions

### ⚠ WARNING

Do not touch any of the terminals while the power is being supplied. Doing so may result in electric shock.

### ⚠ Caution

Do not allow metal objects or conductive wire cuttings to enter the product. Doing so may result in electric shock, fire, or malfunction.

### ⚠ Caution

Do not attempt to take the product apart or touch any internal parts while the power is being supplied. Doing so may result in electric shock.

### ⚠ Caution

Do not use the product in locations subject to flammable or explosive gases. Doing so may result in explosion.

### ⚠ Caution

The lifetime of output relays varies greatly with the switching capacity and conditions. Consider the actual operating conditions, and use the relays within the rated load without exceeding the number of operations specified as the rated electrical life. Using relays beyond their rated electrical life may result in contact deposition or burning.

### ⚠ Caution

Do not use loads exceeding the rated value. Doing so may result in damage or burning.

### ⚠ Caution

Use a power supply voltage within the specified range. Not doing so may result in damage or burning.

### ⚠ Caution

Use settings that are appropriate for the control system. Discrepancies between the settings and the actual control conditions may result in unexpected operation leading to damage or accidents.

### ⚠ Caution

Be sure to tighten terminal screws to the specified torque.  
Specified torque for M3.5 screws: 0.74 to 0.90 N·m  
Loose screws may result in burning or malfunction.

## Application Precautions

- Use a power supply voltage within the specified range. Not doing so may result in damage or burning.
- Be sure to perform wiring correctly, verifying the terminal names. Incorrect wiring may result in burning.
- Be sure to tighten the screws on the terminal block properly.
- Do not connect anything to unused terminals.

## Correct Use

### Long-term Use

Use all products within the specified ranges. When using inside a control panel, ensure that the temperature around the product, rather than the temperature around the control panel, does not exceed the specified temperature range. Electronic products, such as this product, have a lifetime that is dependent on the lifetime of internal electronic components, as opposed to the lifetime related to the number of relay switching operations. The lifetime of these components varies with the temperature; the higher the temperature, the shorter the lifetime. Therefore, the product lifetime can be extended by lowering the internal temperature of the product.

When several Frequency/Rate Meters are mounted close together (either horizontally or vertically), the internal temperature of the Frequency/Rate Meters may rise, leading to a reduction in the lifetime. In this case, take measures to cool the Frequency/Rate Meters, such as installing fans. Ensure, however, that the terminals are not cooled as this may lead to incorrect measurement.

### Operating Environment

Do not use the product in locations subject to temperatures or humidity levels above the specified ranges, or in locations subject to condensation.

Do not use the product in locations subject to severe shocks or vibrations.

Separate the product from machines that generate high-frequency noise, such as high-frequency welding machines and high-frequency sewing machines.

Do not use the product in locations subject to dust or corrosive gases.

Do not use the product outdoors or in locations subject to direct sunlight.

### Operation

When using models with comparative outputs, if an error occurs at the Frequency/Rate Meter, comparative output may not operate correctly. We therefore recommend that you consider providing an alarm system separately as a countermeasure.

Parameter settings that allow the functions to operate properly are made, using the setting menu, at the factory prior to delivery. When using the product, change the settings as required for the application.

### Mounting

Recommended panel thickness is 1 to 3.2 mm.

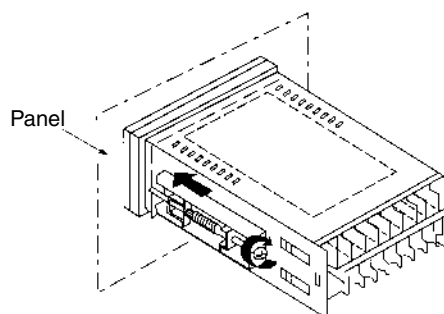



Attach the mounting bracket on the left and right sides of the Frequency/Rate Meter as shown in the illustration above and gradually tighten each screw evenly in turn by considering the balance of the tightening force until the ratchets start slipping without being further tightened.

Mount the Frequency/Rate Meter as horizontally as possible.

**Waterproof Specifications**

Products for which the degree of protection is not specified or models with IP□□ degree of protection do not have waterproof specifications.

**Noise Countermeasures**

Separate the product as far as possible from machines that generate high-frequency noise, such as high-frequency welding machines and high-frequency sewing machines, and machines that generate surges.

Attach surge absorbers or noise filters to noise-generating peripheral devices (in particular, devices with inductance such as motors, transformers, solenoids, and magnet coils).

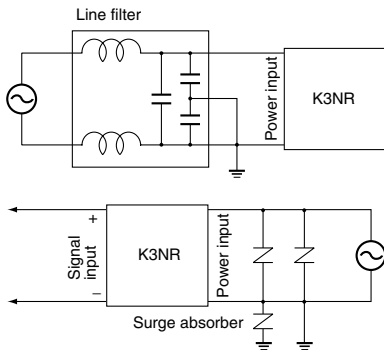

In order to prevent inductive noise, wire the lines connected to the terminal block separately from power lines carrying high voltages or large currents. Also, do not wire in parallel to, or in the same cable as power lines. There are other methods that are effective for reducing noise, such as running wires along ducts and using shield lines.

When using a noise filter for the power supply, check the voltage and current and install as close to the Frequency/Rate Meter as possible.

**Inductive Noise Countermeasure for Input Line**

**Analog Input**

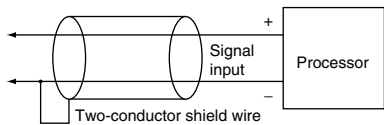

**Temperature Input**

In order to prevent the influence of induction, separate the lead wire joining the temperature sensor and the Frequency/Rate Meter from power and load lines.

Using the product near radios, television sets, or other wireless devices may result in reception interference.

**Unit Label (Provided)**

No product is shipped with the unit label attached. Select a unit label from the sheet provided and attach it to the Frequency/Rate Meter.

A	A	mA	mA	V	kV	s	m'	cm'	rad
V	mV	mV	W	kW	S	S	.	kL	L/s
VA	kVA	var	kvar	Ω	L/min	L/h	kN	mN	Pa
°C	°F	K	Hz	rpm	kPa	mPa	N·m	kN·m	mN·m
m	mm	cm	μm	km	kg·m'	lx	cps	°	rph
ℓ	kℓ	t	TON	ℓx	r/s	r/min	r/h	min <sup>-1</sup>	h <sup>-1</sup>
m'	cm'	mm'	kg	g	秒	時	分	度	h,min,s
mg	kg/m <sup>3</sup>	g/cm <sup>3</sup>	m <sup>3</sup> /kg	m <sup>3</sup> /s	min/10s	時/分	分/100	omeon	
G	N	mmHg	mmH <sub>2</sub> O	kgf/cm <sup>2</sup>					
kgf/mm <sup>2</sup>	J	kJ	kgf·cm	gf·cm					
PS	hp	cal	kcal	kg/h					
t/h	kg/s	m/min	m/h	m/s					
ℓ/s	ℓ/min	ℓ/h	m/min	mm/s					
m/s	%	dB	φ-mm	SCCM					
sec	ms	min	counts	·10					
·100	·1000	pH	ppm	pes					
deg	cP	cSt	kΩ	MΩ					
kHz	rps								

# Operating Procedures

## ■ Operation in RUN Mode

### Reset (Enabled in operating mode 7 only.)

The incremental display value can be reset using key operations.

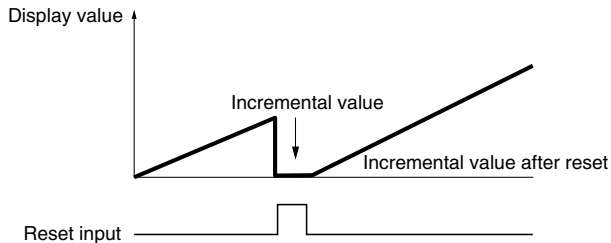

- Press the RESET/TEACH Key during incremental display to reset the incremental value and continue incremental counting operation.
- Reset using the RESET/TEACH Key is not possible if reset of counting values was prohibited in Protect Mode.

### Checking the Bank Number

Press the Shift Key for 1 s min. during measurement to display the bank number in the PV display. (The display will return to the measurement value if there is no key operation for 5 seconds.)

### Bank Selection

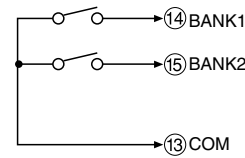

- Switch between the comparative set values and the prescaling values for banks 1 to 4 using the BANK 1 and BANK 2 signals.
- The relationship between the BANK 1 and BANK 2 signals and the bank numbers is shown in the following table.

Bank number	BANK 1	BANK 2	Comparative set value	Prescaling value
1	OFF	OFF	$S_{u1,**}$	$P5_{l,**}$
2	ON	OFF	$S_{u2,**}$	$P5_{2,**}$
3	OFF	ON	$S_{u3,**}$	$P5_{3,**}$
4	ON	ON	$S_{u4,**}$	$P5_{4,**}$

**Note:** If the prescale value bank is set to OFF, then the prescaling value for each bank is fixed.

### Confirming Maximum and Minimum Values

Press the ESC Key during measurement to display the maximum and minimum values.

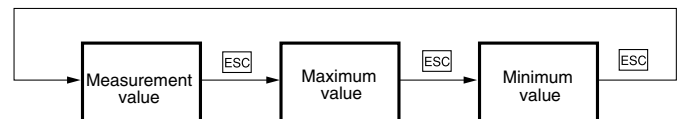

Press the RESET/TEACH Key while the maximum or minimum value is displayed to reset the value. (This is not possible, however, if maximum/minimum value reset was prohibited in Protect Mode.)

### Confirming and Setting Comparative Set Values

When the measurement value, the maximum value, or the minimum value is displayed, press the Mode Key repeatedly to display the comparative set values in the order HH, H, L, and LL. (With models that have an SV display, the comparative set values are displayed in the SV display.)

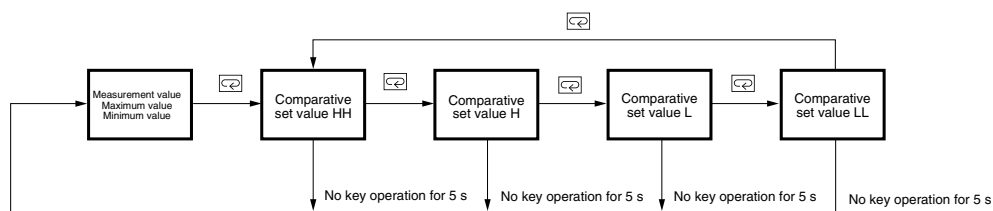

**Note:** When a comparative set value is displayed, it can be changed using the Up Key and Shift Key (if key protection is OFF).

## Setting Procedures

The K3NR has four modes: RUN mode for normal operations, Setting mode for initial parameter input, Protect mode for lock-out configuration, and Maintenance mode for initializing set values. The parameters that are accessible on any individual K3NR will vary depending on the Output Board installed. Refer to the *K3NR Operation Manual* for details.

- RUN Mode:** Remains in this mode under normal operation.  
The process value or the max./min. value can be monitored.  
Using the front panel keys, the comparative set value can be changed and max./min. value and counting value reset can be performed.
- Setting Mode:** Used for making initial settings.  
Includes settings for four menus (Set value (*SuSEt*), prescaling (*PSCL*), setup (*SEtUP*), option (*oPt*)) and the output test.
- Protect Mode:** Used for locking the front key operation or parameter changes.
- Maintenance Mode:** Used for initializing set values.

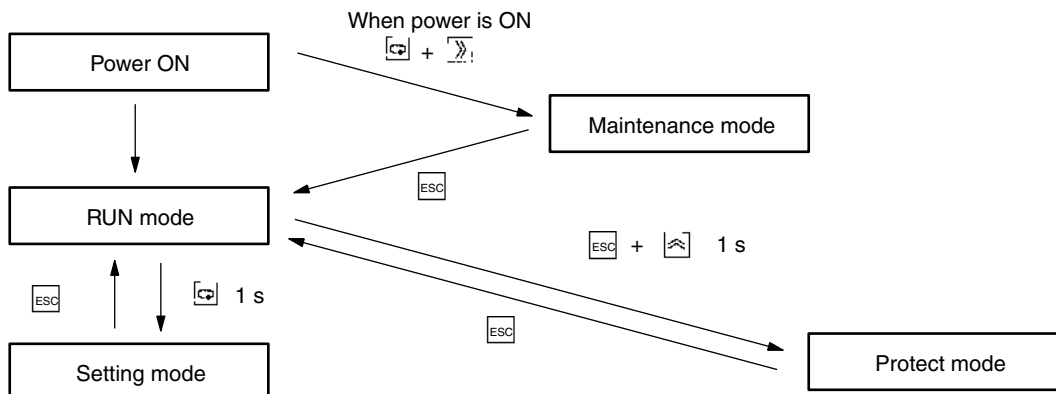

### *SuSEt* - Program set values

- S.bAnP* Select bank no. of set values
- Su\*.HH* Enter set value HH of bank 1
- Su\*. H* Enter set value H of bank 1
- Su\*. L* Enter set value L of bank 1
- Su\*. LL* Enter set value LL of bank 1

**Note:** The above is an example when the bank number is set to 1.

### *PSCL* - Display prescaling

- P.bAnP* Select bank no. of prescale values
- PS\*.A<sub>U</sub>* Set the mantissa (X) of the prescale value of input A
- PS\*.A<sub>Y</sub>* Set the exponent (Y) of the prescale value of input A
- PS\*.b<sub>U</sub>* Set the mantissa (X) of the prescale value of input B
- PS\*.b<sub>Y</sub>* Set the exponent (Y) of the prescale value of input B
- dECP.\** Select decimal point

**Note:** The above is an example when the bank number is set to 1.

### *SEtUP* - Program operating mode/input sensor/serial communications

- FUnC* Specify operating mode
- LnA* Select a sensor type of input A
- LnB* Select a sensor type of input B
- Er.a.A<sub>U</sub>* Set the mantissa (X) of the auto zero time of input A
- Er.a.A<sub>Y</sub>* Set the exponent (Y) of the auto zero time of input A
- Er.a.b<sub>U</sub>* Set the mantissa (X) of the auto zero time of input B
- Er.a.b<sub>Y</sub>* Set the exponent (Y) of the auto zero time of input B

### *oPt* - Supplementary settings related to display or control

- A<sub>U</sub>G* Set the process time for averaging measured value
- StCnE* Set startup compensation time
- nEno* Select power failure memory function
- HYS* Enter hysteresis value
- C-oUt* Select the output pattern
- LSEt.H* Enter the upper limit (H) of linear output range
- LSEt.L* Enter the lower limit (L) of linear output range
- r-L* Select the remote/local programming

### *tEst* - Generating simulated input for testing the output function

### *PrOt* - Program lock-out configuration

- ALL* Enable all key protection
- SuSEt* Enable set value change prohibition
- rESEt* Enable prohibition of counting value reset using the front panel keys
- n.n.rSt* Enable prohibition of max./min. value reset using the front panel keys
- SECr* Specify the menus to be protected against setting in the setting mode

- tCnE* Select the display time unit
- U-nō* Enter the unit no. for the host
- bPS* Select the baud rate
- LEn* Select the word bit length
- SbCt* Select the stop bits
- PrLy* Select the parity bits

## Initial Settings

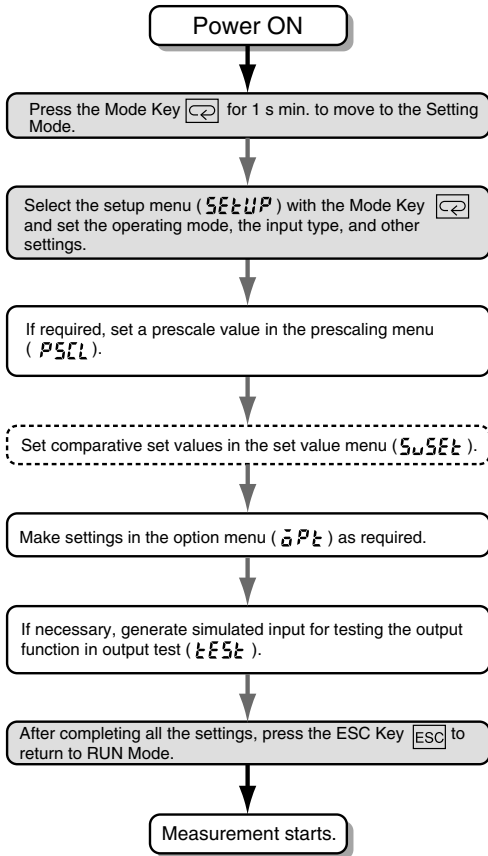

### Prescaling

To display rotational speeds, circumferential speeds, or other values based on input pulse calculations, the rotational speed must be multiplied by a factor input before the input pulses are measured. This factor is called a prescale value.

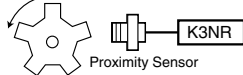

$$\text{Rotation speed (rpm)} = f \times 60 \times a$$

Where,

f: Input pulse frequency (p/s)

a: Prescale value

If there are 5 pulses per rotation, then an accurate rotation speed can be calculated if  $a = 1/5 (= 0.2 = 2 \times 10^{-1})$ .

In actual application, input as follows:

Mantissa X = 2.0000

Exponent Y =  $10^{-1}$

### Auto-zero Time (Set before use.)

In operation modes 1 to 6, the time to force-zero the frequency if no pulse is received for a specified period can be set. This time is called the auto-zero time. Set the auto-zero time to a value that is somewhat longer than the longest input pulse interval. (If the time setting is too long or if the factory-set value is used, the display may not return to zero even if no input pulse is received.)

### Time Unit Setting

Setting	Meaning
SCAL	Set in the prescaling menu
SEC	Seconds
MIN	Minutes
MIN.SS	Minutes and seconds
MIN.SS.d	Hours, minutes, and seconds

**Note:** The time unit can be set only if operating mode 6 (passing time) is selected.

### Selecting the Sensor Type

	NO: Voltage pulse H	NC: Voltage pulse L
No-contact or voltage pulse input	00	01
Contact input	10	11

**Note:** If there are large discrepancies in the display select #0 or #1. Note, however, that the maximum counting frequency is 30 Hz.

## Parameters

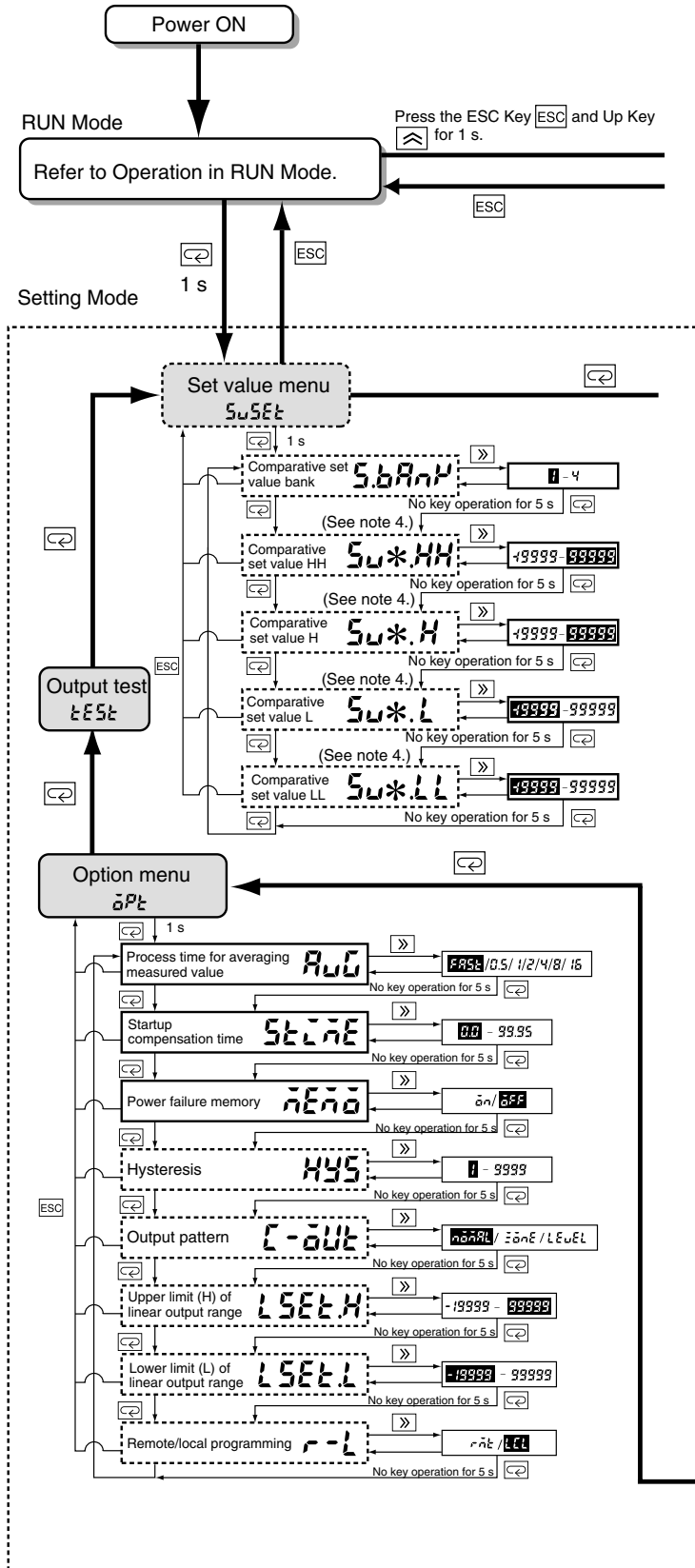

Protect Mode

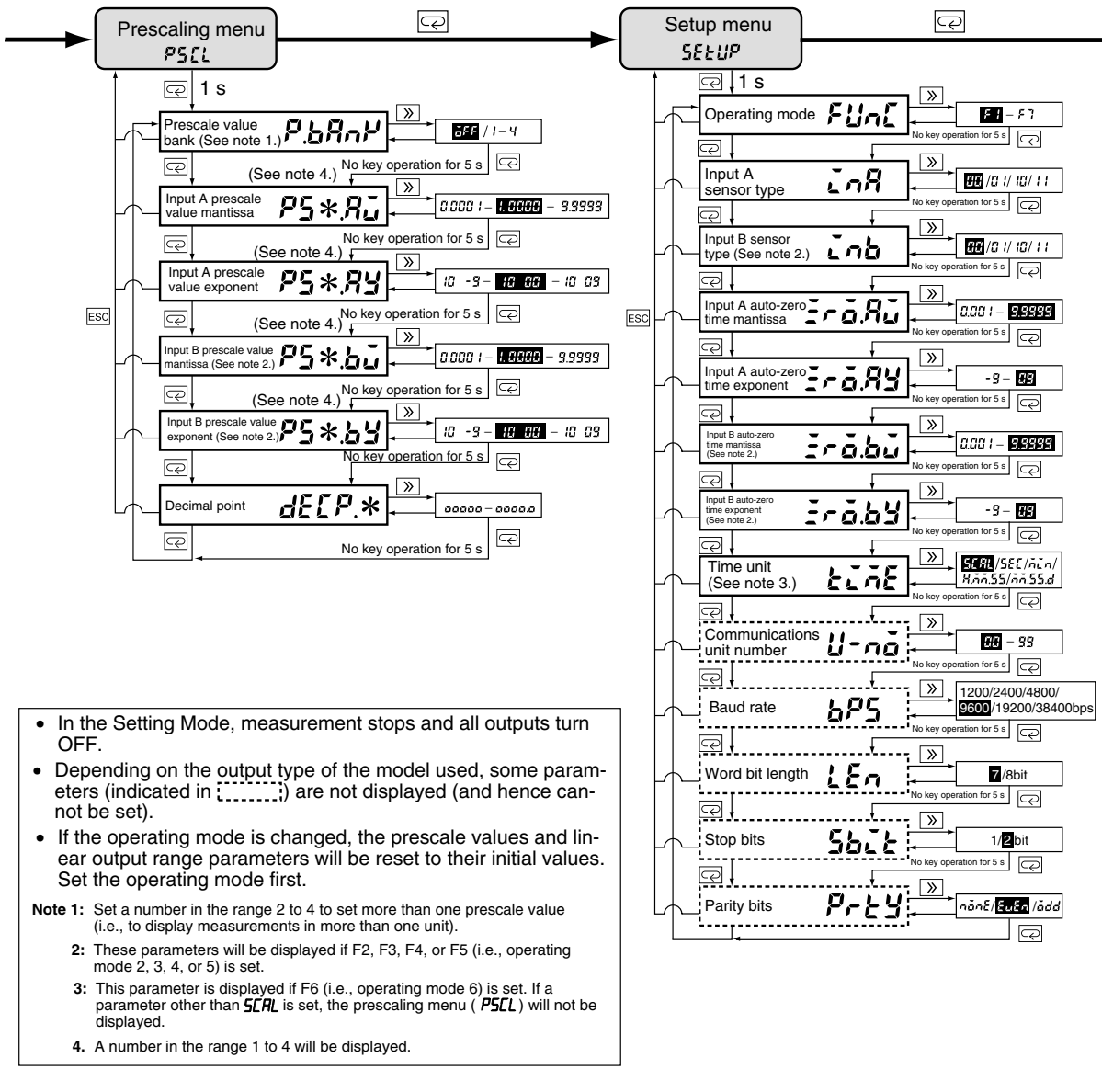
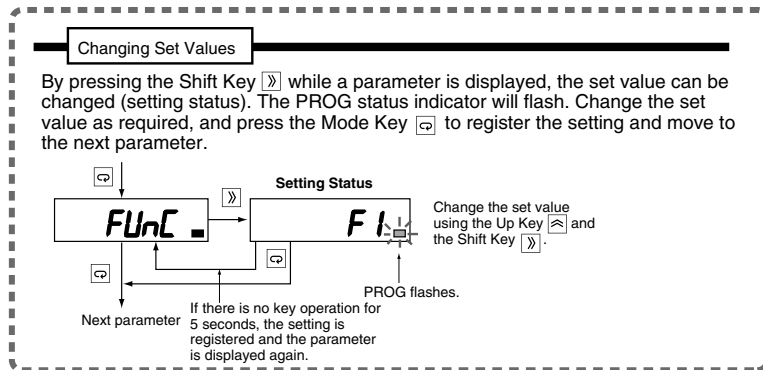

Settings displayed in reverse colors are defaults.

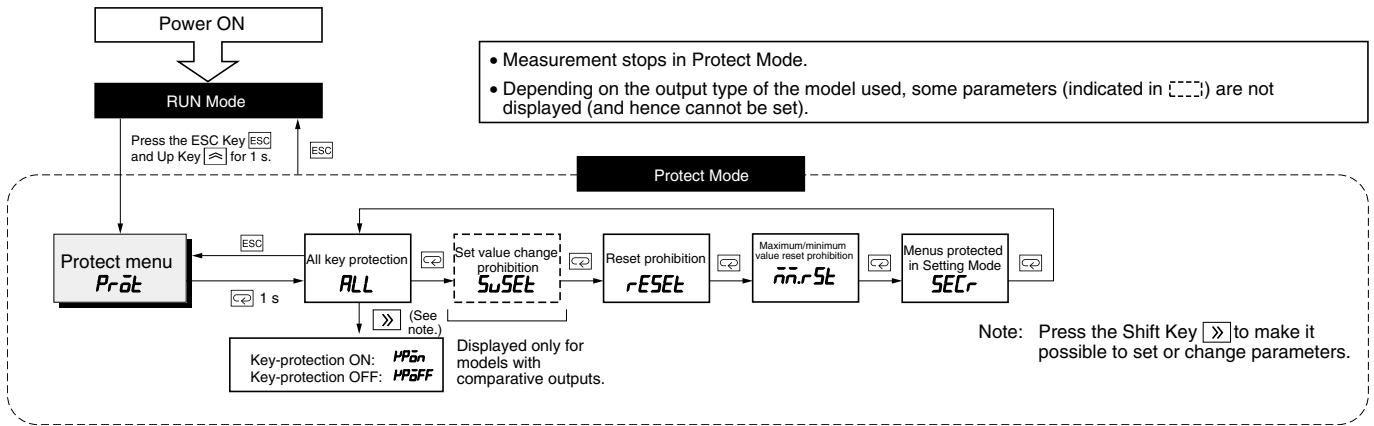

Menu display	Parameter display	Meaning of parameter	Setting range	Setting key (See note.)																							
<b>Pröt</b> Press the Mode Key [←] to display the parameter.  Press the ESC Key [ESC] to return to the menu.	<b>ALL</b> Setting: [→] Next parameter: [←]	All key protection: All key operations are prohibited in RUN Mode. (If all key protection is ON, only the key for going to Protect Mode is enabled.)	Key protection ON: <b>HPōn</b> Key protection OFF: <b>HPōFF</b>	Use the Up Key [↑] to change the setting. (HPōn → HPōFF)  Use the Mode Key [←] to enable the setting and move to the next parameter.																							
	[---] <b>SuSEt</b> Setting: [→] Next parameter: [←]	Set value change prohibition: Changes to comparative set values are prohibited in RUN Mode. (Displayed only for models with comparative outputs.)																									
	<b>rESEt</b> Setting: [→] Next parameter: [←]	Reset prohibition: Resetting using the front panel keys is prohibited. (Resetting by external signals is not prohibited.)																									
	[---] <b>ññ.rSt</b> Setting: [→] Next parameter: [←]	Maximum/minimum value reset prohibition: Resetting of maximum and minimum values using the front panel keys is prohibited. (Resetting by external signals is not prohibited.)																									
	<b>SECr</b> Setting: [→] Next parameter: [←]	Menu protected in Setting Mode: Setting operations in Setting Mode are prohibited in the way shown below.																									
		<table border="1"> <thead> <tr> <th>Setting menu</th> <th colspan="3">Setting</th> </tr> <tr> <td></td> <th>0</th> <th>1</th> <th>2</th> </tr> </thead> <tbody> <tr> <td>Set value menu</td> <td></td> <td></td> <td>×</td> </tr> <tr> <td>Prescaling menu</td> <td></td> <td></td> <td>×</td> </tr> <tr> <td>Setup menu</td> <td></td> <td>×</td> <td>×</td> </tr> <tr> <td>Option menu</td> <td></td> <td></td> <td>×</td> </tr> </tbody> </table>	Setting menu	Setting				0	1	2	Set value menu			×	Prescaling menu			×	Setup menu		×	×	Option menu			×	0 / 12  Use the Up Key [↑] to change the setting. (0 → 1 → 2)  Use the Mode Key [←] to enable the setting and move to the next parameter.
Setting menu	Setting																										
	0	1	2																								
Set value menu			×																								
Prescaling menu			×																								
Setup menu		×	×																								
Option menu			×																								

**Note:** If there is no key operation for 5 seconds, the setting is automatically registered.

## ■ Troubleshooting

When an error occurs, error details will be displayed in the PV display. Take the appropriate countermeasures according to the error displayed.

Error display	Error contents	Output status				Countermeasure
		Comparative output	BCD output	Communications output	Linear output	
$\bar{n}1Err$ (M1.ERR) $\bar{n}2Err$ (M2.ERR)	Memory error	OFF	OFF (all outputs in "H" status)	OFF	OFF	Reset the power. If the same error occurs, repair is necessary.
$\bar{n}3Err$ (M3.ERR)		OFF	OFF (all outputs in "H" status)	OFF	OFF	Reset the power while holding down the ESC Key, the Up Key, and the RESET/TEACH Key. The settings will be returned to their initial values. Redo the settings. If the same error occurs, repair is necessary.
$Err-\bar{o}$ (ERR-O) $CHG-\bar{o}$ (CHG-O)	Output error	OFF	OFF (all outputs in "H" status)	OFF	OFF (minimum value)	Reset the power. If the same error occurs, repair is necessary. If normal operation is restored, it is possible that the original error was caused by the influence of noise. Check that there are no sources of noise in the vicinity.
(Display value flashes.)	The input range and display range were exceeded.	Continues	Continues The OVER signal turns ON.	Continues The OVER or UNDER signal turns ON.	Continues	Take steps to ensure that the input values and display values are within the allowable ranges.
$r\bar{n}t$ (RMT) (Flashes for 3 s.)	The remote/local section is set to remote.	Continues	Continues	Continues	Continues	If an attempt to change a setting using key operations is made with the remote/local selection set to remote, this error will flash for 3 s. To enable settings to be changed, set the remote/local selection to local.

## Additional Information

### Output Operation Timing in RUN Mode (Relay or Transistor Outputs)

The following timing chart is for a 5-comparative Output Board when the standard output pattern is selected.

#### For Operating Mode 1 to 6

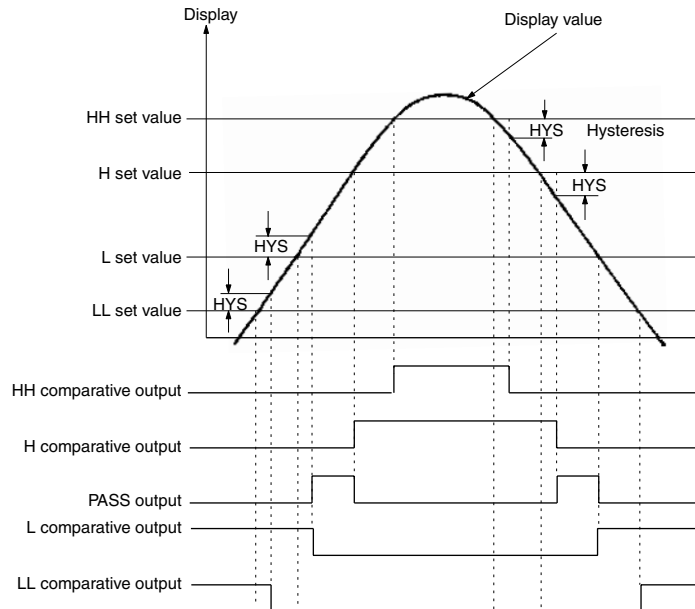

**Note:** The hysteresis is set in setting mode and the hysteresis value will be applied to all set values.

#### For Operating Mode 7

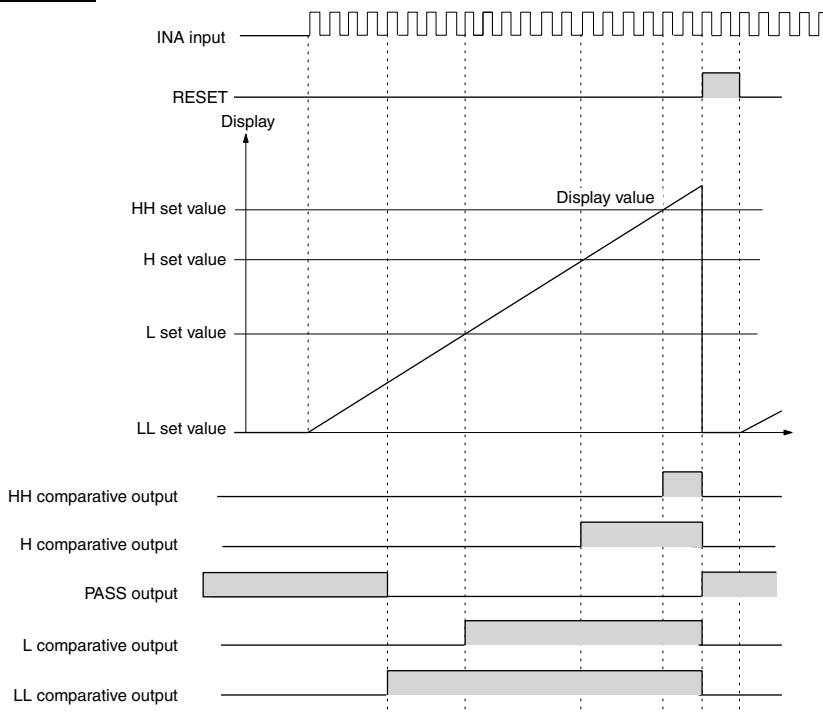

**Note:** Comparative output L or LL turns ON when the measured value exceeds the set value.



## Operating Modes

The K3NR provides 7 operating modes for converting input pulses to display values. The mode can be selected via key operations on the front panel.

Basically, the operating modes can be divided into the following two groups.

### Operating Modes 1 to 6

Rotational speed and other displays are based on calculations for continuous pulses (frequency).

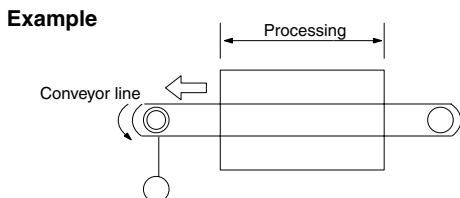

Operating mode no.	Use
01	Rotational/Circumferential speed
02	Absolute ratio
03	Error ratio
04	Rotation difference
05	Flow rate ratio
06	Passing time

Mode No. 1: Rotational or circumferential speed display for 1 input

Mode No. 2 to 5: Display of calculations for two rotational speeds

Mode No. 6: Passing time display based on 1 input frequency and processing length

#### Basic Principles of Rotational Speed Displays

The ON/OFF time (T) of a sensor input or other input is measured with the internal system clock to automatically calculate the frequency. This frequency is multiplied by 60 and displayed as a rotational speed.

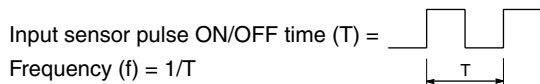

Rotational speed (rpm) = f x 60

Circumferential speed = Circumference x Rotational speed

Passing time = Processing length/Circumferential speed

Automatic measuring by the K3NR is enabled simply by providing an input pulse.

### Operating Mode 7

The number of pulses is measured. Each pulse is counted as 1 count up to a maximum of 99,999 counts. Decrementing the count is not possible. Although the limits of the display enables displaying only up to 99,999 counts, prescaling can be used to count up to 4 gigacounts.

Operating mode no.	Use
07	Pulse counting

The count is reset by shorting terminals 6 and 7 (RESET ON) or by pressing the RESET/TEACH Key on the front panel

Because only incrementing is possible, the L and LL comparative outputs turn ON when the measured values exceed set values.

### Operating Mode 1: Rotational/Circumferential Speed

The frequency of input A is calculated and displayed as a rotational or circumferential speed.

**Units:** rpm; rps; rph; Hz; kHz; mm/s; m/s; m/min; km/h; l/min; l/h; etc.

#### Application Example

##### Measuring Roller Winding Speed

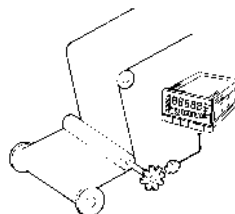

##### Measuring Motor Speed (for Product Testing)

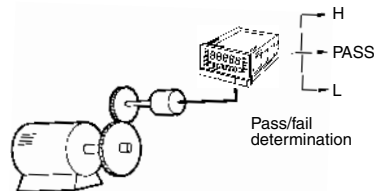

## Operating Mode 2: Absolute Ratio

Input B is divided by input A ( $B/A$ ) and then multiplied by 100 for display as a percentage.

Unit: %

## Operating Mode 3: Error Ratio

The error between input A and input B ( $B/A - 1$ ) is multiplied by 100 for display as a percentage.

Unit: %

## Operating Mode 4: Rotational Difference

The difference between input B and input A ( $B - A$ ) is displayed as a rotational speed error or circumferential speed error.

Units: rpm; rps; rph; Hz; kHz; mm/s; m/s; m/min; km/h;  $\mu$ /min;  $\mu$ /h; etc.

## Operating Mode 5: Flow Rate Ratio

Input A and input B are used to find the concentration ( $B/(A+B)$ ) as a percentage.

Unit: %

### Application Example

Measuring Ratio between Rotational Speed of Two Rollers

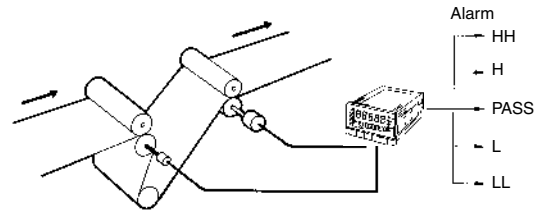

### Application Example

Measuring Difference between Two Line Speeds (Two Conveyors)

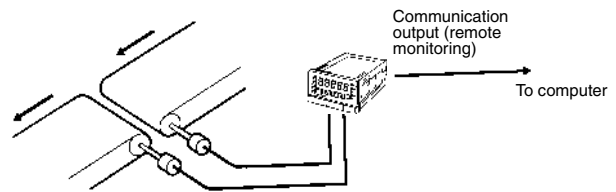

### Application Example

Measuring the Absolute Difference between the Speeds of Two Conveyors

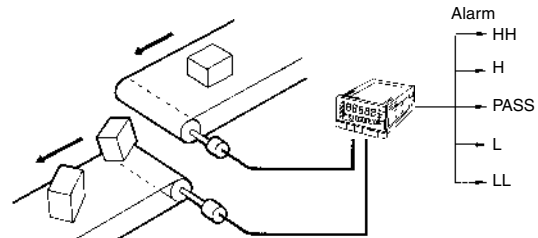

### Application Example

Monitoring the Concentration of a Liquid Mixture

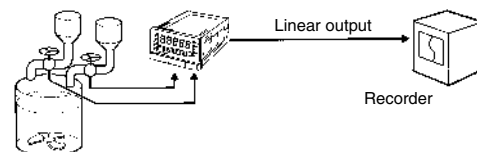

## Operating Mode 6: Passing Time

The pulse frequency of input A is calculated and is displayed as the passing time for a preset distance.

**Units:** s; min; h, min, s; min, s, 1/10 s; etc.

The passing time measurement operation in operating mode 6 is ideal for measuring time corresponding to a frequency change. Operating mode 6 allows the real-time, continuous time measurement of the revolutions of any rotating object without recovery time.

## Application Example

### Passing Time for a Conveyor Line

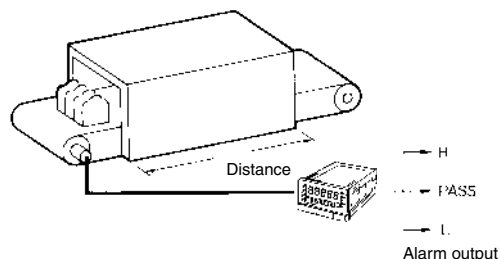

## Operating Mode 7: Pulse Counting

The total number of pulses on input A is displayed.

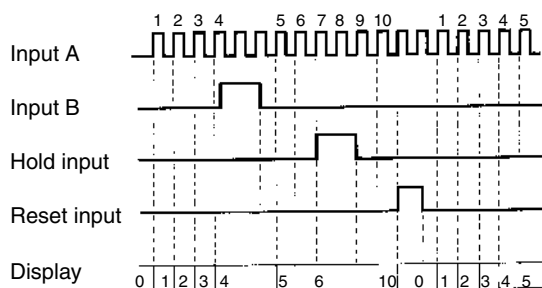

**Units:** count; mm; cm; m; l; kl; etc.

## Application Example

### Counting Workpieces

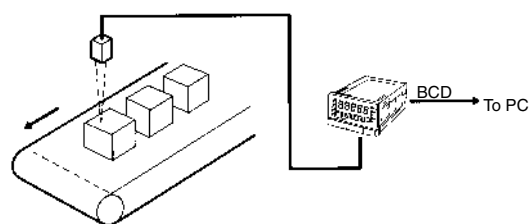

**Note:** The operation of comparative outputs in operating mode 7 is different to that in other modes. Because only incrementing is possible, the L and LL comparative outputs turn ON when the measured values exceed set values.

ALL DIMENSIONS SHOWN ARE IN MILLIMETERS.

To convert millimeters into inches, multiply by 0.03937. To convert grams into ounces, multiply by 0.03527.

Cat. No. N087-E1-02

In the interest of product improvement, specifications are subject to change without notice.