

TELEFUNKEN electronic

Creative Technologies

K 102 P

T-41-83

Optically Coupled Isolator

Construction: Emitter: GaAs IR Emitting Diode
 Detector: Silicon NPN Epitaxial Planar Phototransistor

Applications: Galvanically separated circuits,
 non-interacting switches

Features:

- DC isolation test voltage V_{is} 4.4 kV
- Low coupling capacity C_k typ. 0.3 pF
- Test class 25/100/21 DIN 40045
- Current transfer ratio in groups selected
- Low temperature coefficient of CTR

Dimensions in mm

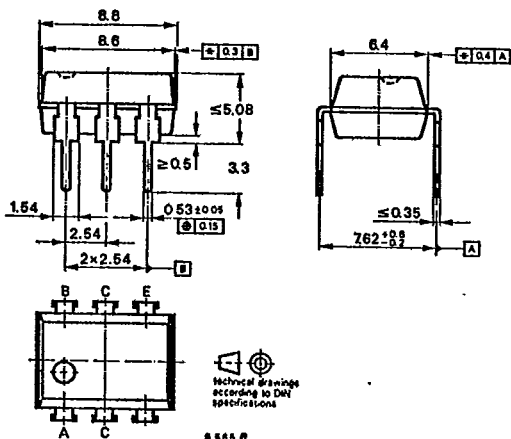

Pin connections

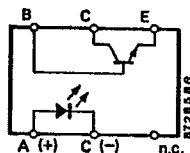

Plastic case
 DIP 6
 Weight max. 0.7 g

Absolute maximum ratings

Emitter

Reverse voltage	V_R	5	V
Forward current	I_F	50	mA
Forward surge current	I_{FSM}	1.5	A
$\frac{t_p}{T} \leq 10 \mu s$			
Power dissipation	P_V	120	mW
$T_{amb} \leq 25 \text{ }^\circ\text{C}$			
Junction temperature	T_J	125	$^\circ\text{C}$

K 102 P

T-41-83

Detector

Collector base voltage	V_{CBO}	50	V
Collector emitter voltage	V_{CEO}	32	V
Emitter collector voltage	V_{ECO}	7	V
Collector current	I_C	50	mA
Peak collector current			
$\frac{t}{T} = 0.5, t_p \leq 10 \text{ ms}$	I_{CM}	100	mA
Power dissipation			
$T_{amb} = 25^\circ\text{C}$	P_V	130	mW
Junction temperature	T_j	125	$^\circ\text{C}$

Coupled device

DC isolation test voltage			
$t = 1 \text{ min.}$	$V_{is}^{1)}$	4.4	V
Total power dissipation			
$T_{amb} \leq 25^\circ\text{C}$	P_{tot}	250	mW
Ambient temperature range	T_{amb}	-55...+100	$^\circ\text{C}$
Storage temperature range	T_{stg}	-55...+125	$^\circ\text{C}$
Soldering temperature			
2 mm from case, $t \leq 10 \text{ s}$	T_{sd}	260	$^\circ\text{C}$

Electrical characteristics

 $T_{amb} = 25^\circ\text{C}$

Min. Typ. Max.

Emitter

Forward voltage			
$I_F = 50 \text{ mA}$	V_F	1.25	1.6 V
Breakdown voltage			
$I_R = 100 \mu\text{A}$	$V_{(BR)}$	5	V
Junction capacitance			
$V_R = 0, f = 1 \text{ MHz}$	C_j	50	pF

Detector

Collector emitter breakdown voltage			
$I_C = 1 \text{ mA}$	$V_{(BR)CEO}$	32	V
Collector dark current			
$V_{CE} = 20 \text{ V}, I_F = 0, E = 0$	I_{CEO}		200 nA
$V_{CE} = 10 \text{ V}, I_F = 0, E = 0$	I_{CEO}		50 nA
$V_{CB} = 10 \text{ V}, I_F = 0, E = 0$	I_{CBO}		20 nA
Collector emitter saturation voltage			
$I_C = 1 \text{ mA}, I_F = 10 \text{ mA}$	V_{CEsat}		0.3 V

¹⁾ related to standard climate 23/50 DIN 50014

K 102 P

T-41-83

Coupled device		Min.	Typ.	Max.	
DC isolation test voltage					
$t = 1 \text{ min}$	$V_{is}^{1)}$	4.4			kV
Isolation resistance					
$V_{IO} = 1 \text{ kV}$, 40% relative humidity	$R_{is}^{1)}$		10^{12}		Ω
Collector current					
$V_{CE} = 5 \text{ V}$, $I_F = 10 \text{ mA}$	K 102 P1	I_C	2	6	mA
	K 102 P2	I_C	4		8 mA
	K 102 P3	I_C	6.2		12.5 mA
$I_F = 2 \text{ mA}$	K 102 P2	I_C	0.4		1 mA
	K 102 P3	I_C	0.5		1.2 mA
Current transfer ratio					
$V_{CE} = 5 \text{ V}$, $I_F = 10 \text{ mA}$	K 102 P1	CTR	20	60	%
	K 102 P2	CTR	40		80 %
	K 102 P3	CTR	62		125 %
$I_F = 2 \text{ mA}$	K 102 P2	CTR	20		50 %
	K 102 P3	CTR	25		60 %
Cut-off frequency					
$V_{CE} = 5 \text{ V}$, $I_F = 10 \text{ mA}$, $R_L = 100 \Omega$	f_g		110		kHz
Coupling capacitance					
$f = 1 \text{ MHz}$	C_k		0.3		pF
Switching characteristics					
$V_S = 5 \text{ V}$, $I_C = 5 \text{ mA}$, $R_L = 100 \Omega$, see Fig. 1					
Delay time	t_d		4.0		μs
Rise time	t_r		7.0		μs
Turn-on time	t_{on}		11.0		μs
Storage time	t_s		0.3		μs
Fall time	t_f		6.7		μs
Turn-off time	t_{off}		7.0		μs
$V_S = 5 \text{ V}$, $I_F = 10 \text{ mA}$, $R_L = 1 \text{ k}\Omega$, see Fig. 2					
Turn-on time	t_{on}		25		μs
Turn-off time	t_{off}		42.5		μs

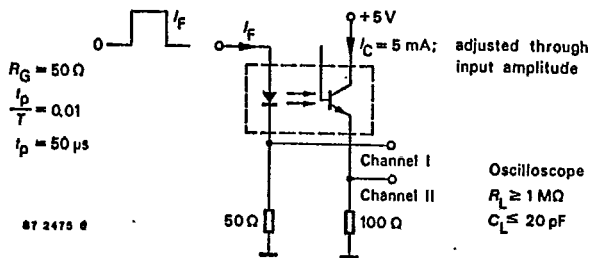
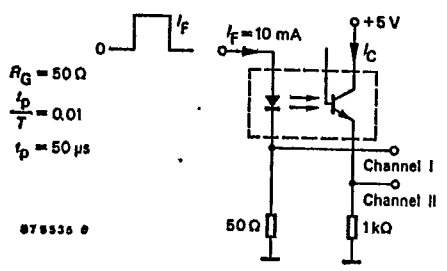

Fig. 1 Test circuit, non saturated operation

¹⁾ related to standard climate 23/50 DIN 50014

K 102 P

T-41-83



Oscilloscope
 $R_L \approx 1 \text{ M}\Omega$
 $C_L \leq 20 \text{ pF}$

Fig. 2 Test circuit, saturated operation

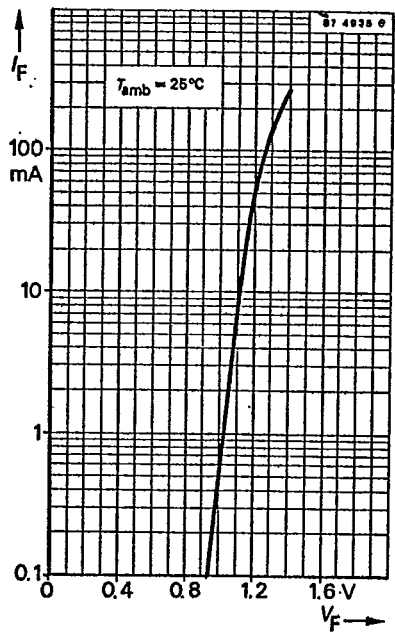
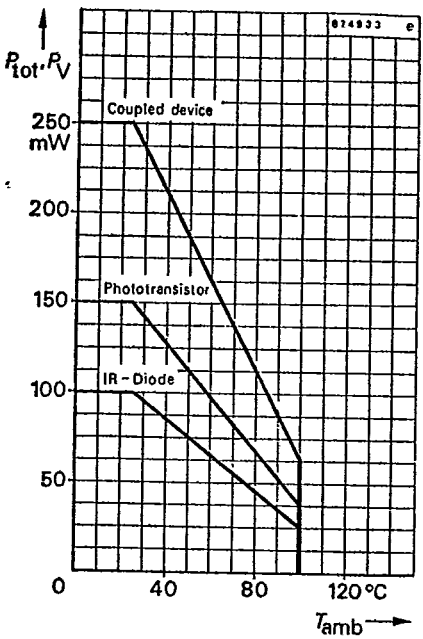

K 102 P

T-41-83

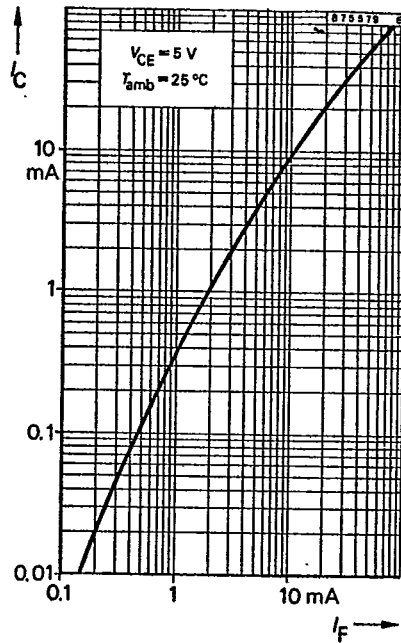
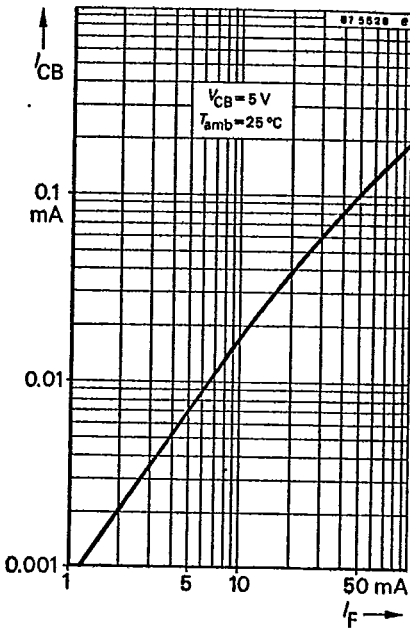
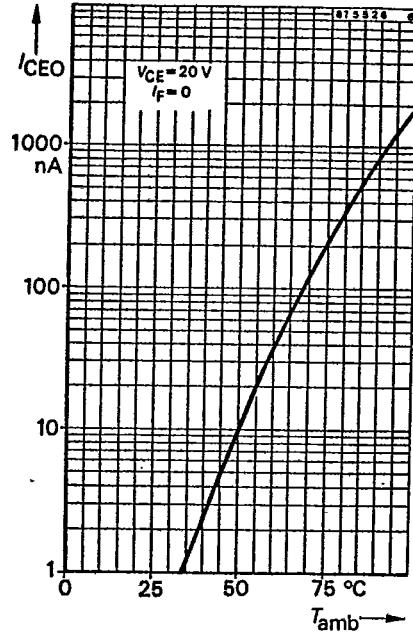
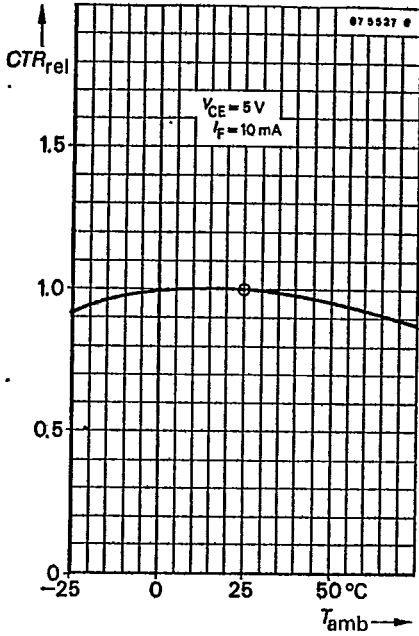

K 102 P

T-41-83

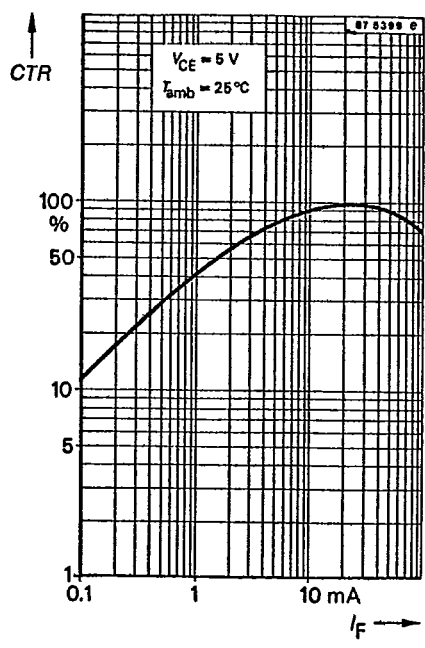
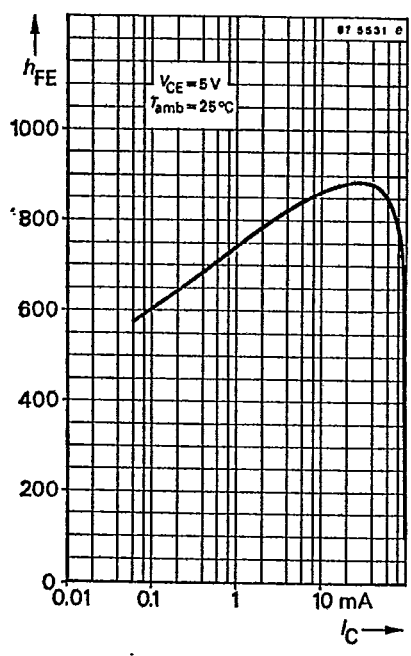
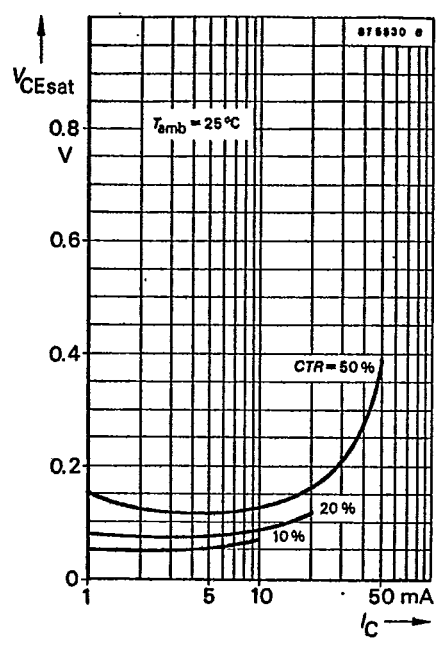
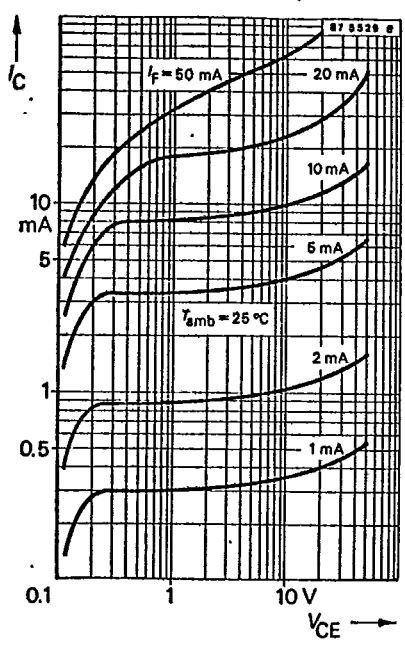

K 102 P

T-41-83

