

International
IR Rectifier
 REPETITIVE AVALANCHE AND dv/dt RATED
HEXFET® TRANSISTOR

PD - 90672C

IRHF7230
IRHF8230
JANSR2N7262
JANSH2N7262
[REF:MIL-PRF-19500/601]
 N CHANNEL
MEGA RAD HARD

200Volt, 0.35Ω, MEGA RAD HARD HEXFET

International Rectifier's RAD HARD technology HEXFETs demonstrate excellent threshold voltage stability and breakdown voltage stability at total radiation doses as high as 1×10^6 Rads(Si). Under **identical** pre- and post-irradiation test conditions, International Rectifier's RAD HARD HEXFETs retain **identical** electrical specifications up to 1×10^5 Rads (Si) total dose. No compensation in gate drive circuitry is required. These devices are also capable of surviving transient ionization pulses as high as 1×10^{12} Rads (Si)/Sec, and return to normal operation within a few microseconds. Since the RAD HARD process utilizes International Rectifier's patented HEXFET technology, the user can expect the highest quality and reliability in the industry.

RAD HARD HEXFET transistors also feature all of the well-established advantages of MOSFETs, such as voltage control, very fast switching, ease of paralleling and temperature stability of the electrical parameters. They are well-suited for applications such as switching power supplies, motor controls, inverters, choppers, audio amplifiers and high-energy pulse circuits in space and weapons environments.

Product Summary

Part Number	BVdss	RDS(on)	Id
IRHF7230	200V	0.35Ω	5.5A
IRHF8230	200V	0.35Ω	5.5A

Features:

- Radiation Hardened up to 1×10^6 Rads (Si)
- Single Event Burnout (SEB) Hardened
- Single Event Gate Rupture (SEGR) Hardened
- Gamma Dot (Flash X-Ray) Hardened
- Neutron Tolerant
- Identical Pre- and Post-Electrical Test Conditions
- Repetitive Avalanche Rating
- Dynamic dv/dt Rating
- Simple Drive Requirements
- Ease of Paralleling
- Hermetically Sealed
- Surface Mount
- Lightweight

Absolute Maximum Ratings ①

Pre-Irradiation

	Parameter	IRHF7230, IRHF8230	Units
Id @ VGS = 12V, TC = 25°C	Continuous Drain Current	5.5	A
Id @ VGS = 12V, TC = 100°C	Continuous Drain Current	3.5	
IDM	Pulsed Drain Current ②	22	
PD @ TC = 25°C	Max. Power Dissipation	25	W
	Linear Derating Factor	0.2	W/°C
VGS	Gate-to-Source Voltage	±20	V
EAS	Single Pulse Avalanche Energy ③	240	mJ
dv/dt	Peak Diode Recovery dv/dt ④	5.0	V/ns
TJ	Operating Junction	-55 to 150	°C
TSTG	Storage Temperature Range		
	Lead Temperature	300 (0.063 in. (1.6mm) from case for 10s)	
	Weight	0.98 (typical)	g

Electrical Characteristics @ T_j = 25°C (Unless Otherwise Specified) ①

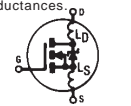
	Parameter	Min	Typ	Max	Units	Test Conditions
BV _{DSS}	Drain-to-Source Breakdown Voltage	200	—	—	V	V _{GS} = 0V, I _D = 1.0mA
ΔBV _{DSS} /ΔT _J	Temperature Coefficient of Breakdown Voltage	—	0.25	—	V/°C	Reference to 25°C, I _D = 1.0mA
R _D S(on)	Static Drain-to-Source On-State Resistance	—	—	0.35	Ω	V _{GS} = 12V, I _D = 3.5A ⑤
		—	—	0.36		V _{GS} = 12V, I _D = 5.5A ⑤
V _{GS(th)}	Gate Threshold Voltage	2.0	—	4.0	V	V _{DS} = V _{GS} , I _D = 1.0mA
g _{fs}	Forward Transconductance	2.5	—	—	S (τ)	V _{DS} > 15V, I _{DS} = 3.5A ⑤
I _{DSS}	Zero Gate Voltage Drain Current	—	—	25	μA	V _{DS} = 0.8 x Max Rating, V _{GS} = 0V
		—	—	250		V _{DS} = 0.8 x Max Rating V _{GS} = 0V, T _J = 125°C
I _{GSS}	Gate-to-Source Leakage Forward	—	—	100	nA	V _{GS} = 20V
I _{GSS}	Gate-to-Source Leakage Reverse	—	—	-100		V _{GS} = -20V
Q _g	Total Gate Charge	—	—	50	nC	V _{GS} = 12V, I _D = 5.5A
Q _{gs}	Gate-to-Source Charge	—	—	10		V _{DS} = Max Rating x 0.5
Q _{gd}	Gate-to-Drain ('Miller') Charge	—	—	25		
t _{d(on)}	Turn-On Delay Time	—	—	25	ns	V _{DD} = 100V, I _D = 5.5A, R _G = 7.50Ω
t _r	Rise Time	—	—	40		
t _{d(off)}	Turn-Off Delay Time	—	—	60		
t _f	Fall Time	—	—	45		
L _D	Internal Drain Inductance	—	5.0	—	nH	<p>Measured from drain lead, 6mm (0.25 in) from package to center of die.</p> <p>Measured from source lead, 6mm (0.25 in) from package to source bonding pad.</p> 
L _S	Internal Source Inductance	—	15	—		
C _{iss}	Input Capacitance	—	1100	—	pF	V _{GS} = 0V, V _{DS} = 25V f = 1.0MHz
C _{oss}	Output Capacitance	—	250	—		
C _{rss}	Reverse Transfer Capacitance	—	55	—		

Source-Drain Diode Ratings and Characteristics ①

	Parameter	Min	Typ	Max	Units	Test Conditions
I _S	Continuous Source Current (Body Diode)	—	—	5.5	A	Modified MOSFET symbol showing the integral reverse p-n junction rectifier. 
I _{SM}	Pulse Source Current (Body Diode) ②	—	—	22		
V _{SD}	Diode Forward Voltage	—	—	1.4	V	T _j = 25°C, I _S = 5.5A, V _{GS} = 0V ⑤
t _{rr}	Reverse Recovery Time	—	—	400	ns	T _j = 25°C, I _F = 5.5A, di/dt ≤ 100A/μs
Q _{RR}	Reverse Recovery Charge	—	—	3.0	μC	V _{DD} ≤ 50V ⑤
t _{on}	Forward Turn-On Time	Intrinsic turn-on time is negligible. Turn-on speed is substantially controlled by L _S + L _D .				

Thermal Resistance

	Parameter	Min	Typ	Max	Units	Test Conditions
R _{thJC}	Junction-to-Case	—	—	5.0	°C/W	Typical socket mount
R _{th-PCB}	Junction-to-Ambient	—	—	175		

IRHF7230, IRHF8230, JANSR-, JANSR-, 2N7262 Devices Radiation Characteristics

Radiation Performance of Rad Hard HEXFETs

International Rectifier Radiation Hardened HEXFETs are tested to verify their hardness capability. The hardness assurance program at International Rectifier comprises three radiation environments.

Every manufacturing lot is tested in a low dose rate (total dose) environment per MIL-STD-750, test method 1019 condition A. International Rectifier has imposed a standard gate condition of 12 volts per note 6 and a V_{DS} bias condition equal to 80% of the device rated voltage per note 7. Pre- and post- irradiation limits of the devices irradiated to 1×10^5 Rads (Si) are identical and are presented in Table 1, column 1, IRHF7230. Post-irradiation limits of the devices irradiated to 1×10^6 Rads (Si) are presented in Table

1, column 2, IRHF8230. The values in Table 1 will be met for either of the two low dose rate test circuits that are used. Both pre- and post-irradiation performance are tested and specified using the same drive circuitry and test conditions in order to provide a direct comparison.

High dose rate testing may be done on a special request basis using a dose rate up to 1×10^{12} Rads (Si)/Sec (See Table 2).

International Rectifier radiation hardened HEXFETs have been characterized in heavy ion Single Event Effects (SEE) environments. Single Event Effects characterization is shown in Table 3.

Table 1. Low Dose Rate ⑥ ⑦

	Parameter	IRHF7230		IRHF8230		Units	Test Conditions ⑨
		Min	Max	Min	Max		
BV_{DSS}	Drain-to-Source Breakdown Voltage	200	—	200	—	V	$V_{GS} = 0V, I_D = 1.0mA$
$V_{GS(th)}$	Gate Threshold Voltage ⑤	2.0	4.0	1.25	4.5		$V_{GS} = V_{DS}, I_D = 1.0mA$
I_{GSS}	Gate-to-Source Leakage Forward	—	100	—	100	nA	$V_{GS} = 20V$
I_{GSS}	Gate-to-Source Leakage Reverse	—	-100	—	-100		$V_{GS} = -20V$
I_{DSS}	Zero Gate Voltage Drain Current	—	25	—	50	μA	$V_{DS} = 0.8 \times \text{Max Rating}, V_{GS} = 0V$
$R_{DS(on)1}$	Static Drain-to-Source On-State Resistance One ⑤	—	1.225	—	1.68	Ω	$V_{GS} = 12V, I_D = 3.5A$
V_{SD}	Diode Forward Voltage ⑤	—	1.4	—	1.4	V	$T_C = 25^\circ C, I_S = 5.5A, V_{GS} = 0V$

Table 2. High Dose Rate ⑧

	Parameter	10^{11} Rads (Si)/sec			10^{12} Rads (Si)/sec			Units	Test Conditions
		Min	Typ	Max	Min	Typ	Max		
V_{DSS}	Drain-to-Source Voltage	—	—	160	—	—	160	V	Applied drain-to-source voltage during gamma-dot
I_{pp}		—	20	—	—	20	—	A	Peak radiation induced photo-current
di/dt		—	—	160	—	—	8.0	A/ μsec	Rate of rise of photo-current
L_1		1.0	—	—	20	—	—	μH	Circuit inductance required to limit di/dt

Table 3. Single Event Effects

Ion	LET (Si) (MeV/mg/cm ²)	Fluence (ions/cm ²)	Range (μm)	V_{DS} Bias (V)	V_{GS} Bias (V)
Cu	28	3×10^5	~43	180	-5

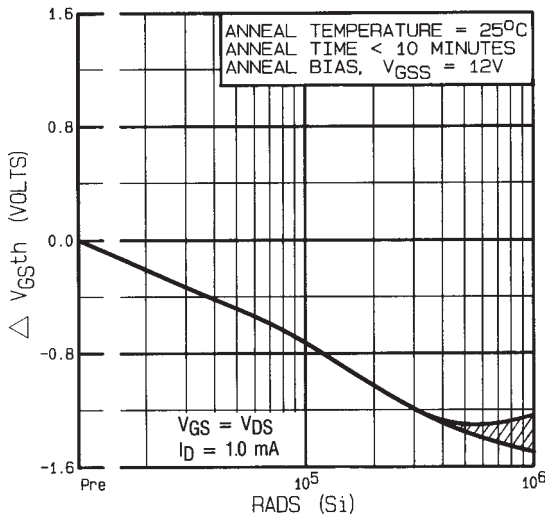

Fig 1. Typical Response of Gate Threshold Voltage Vs. Total Dose Exposure

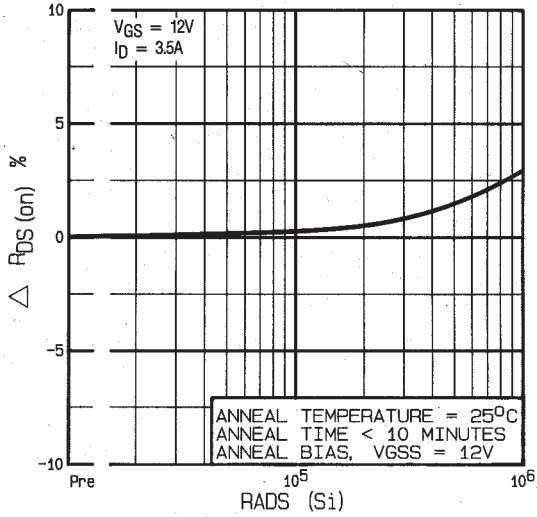

Fig 2. Typical Response of On-State Resistance Vs. Total Dose Exposure

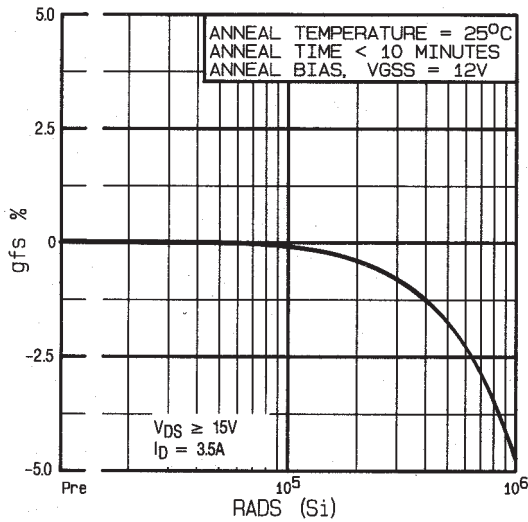

Fig 3. Typical Response of Transconductance Vs. Total Dose Exposure

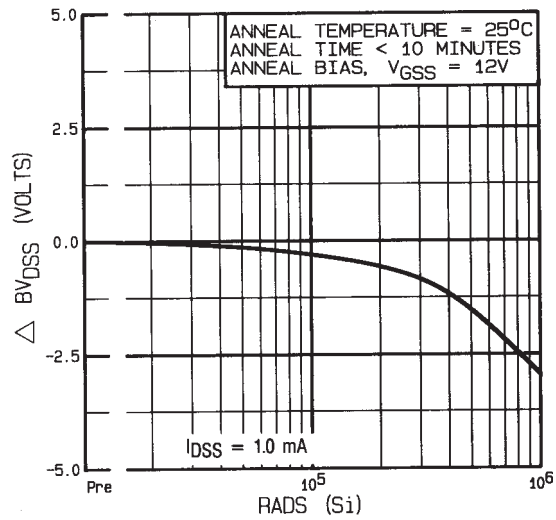

Fig 4. Typical Response of Drain to Source Breakdown Vs. Total Dose Exposure

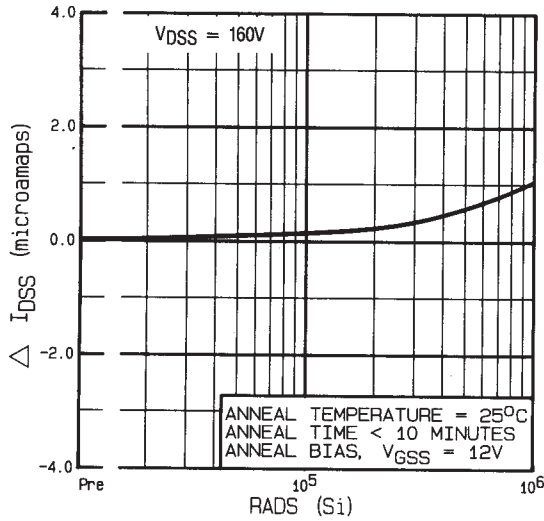

Fig 5. Typical Zero Gate Voltage Drain Current Vs. Total Dose Exposure

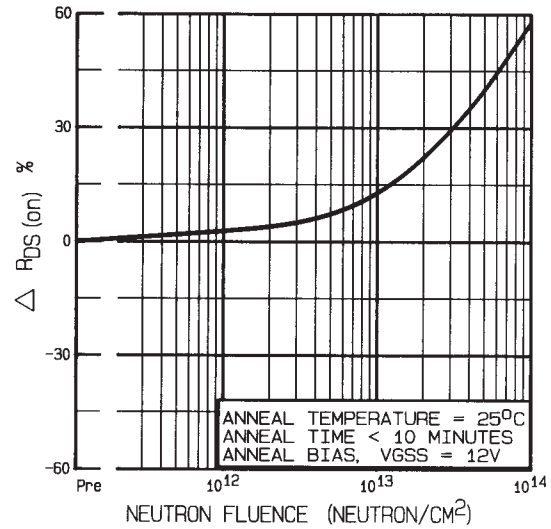

Fig 6. Typical On-State Resistance Vs. Neutron Fluence Level

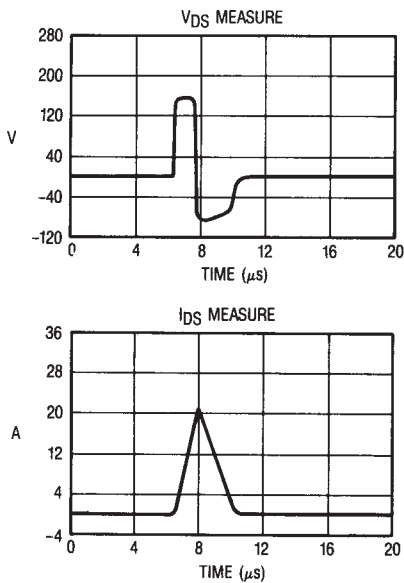

Fig 7. Typical Transient Response of Rad Hard HEXFET During 1×10^{12} Rad (Si)/Sec Exposure

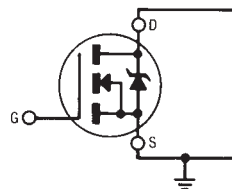

Fig 8a. Gate Stress of V_{GSS} Equals 12 Volts During Radiation

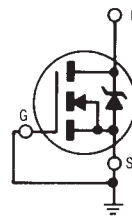

Fig 8b. V_{DSS} Stress Equals 80% of $B_{V_{DSS}}$ During Radiation

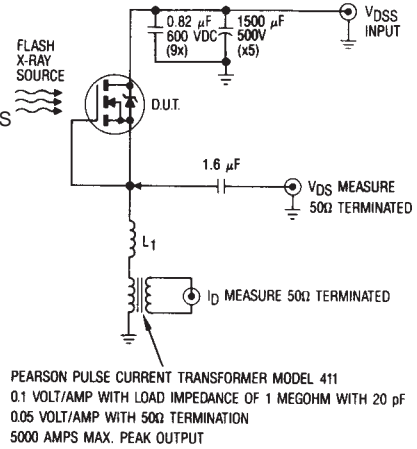

Fig 9. High Dose Rate (Gamma Dot) Test Circuit

IRHF7230, IRHF8230, JANSR-, JANSH-, 2N7262 Devices Radiation Characteristics

Note: Bias Conditions during radiation: $V_{GS} = 12 \text{ Vdc}$, $V_{DS} = 0 \text{ Vdc}$

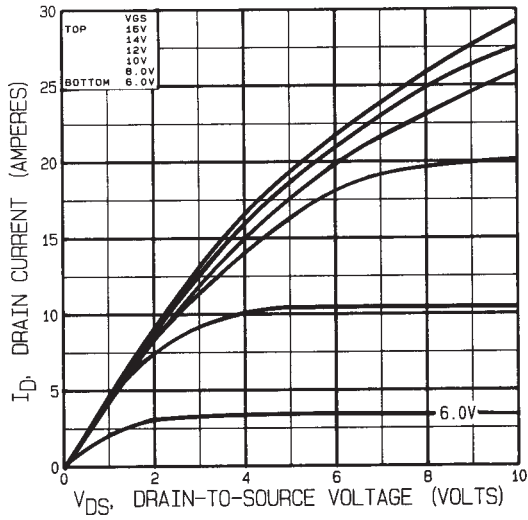

Fig 10. Typical Output Characteristics
Pre-Irradiation

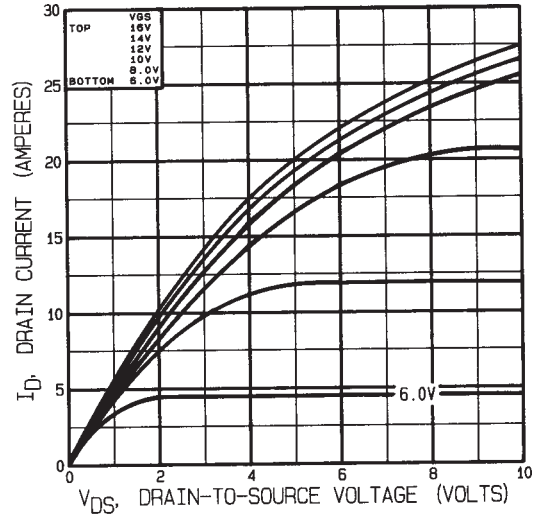

Fig 11. Typical Output Characteristics
Post-Irradiation 100K Rads (Si)

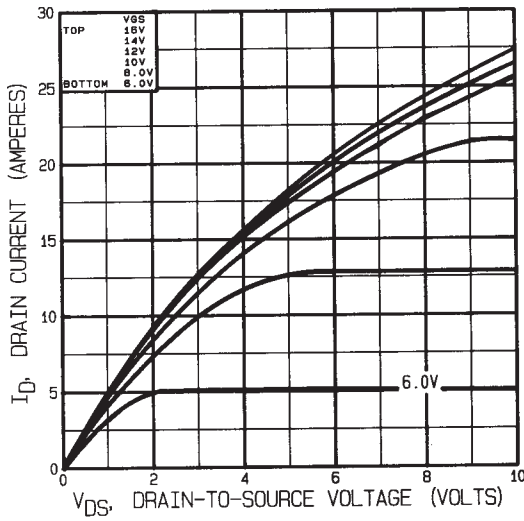

Fig 12. Typical Output Characteristics
Post-Irradiation 300K Rads (Si)

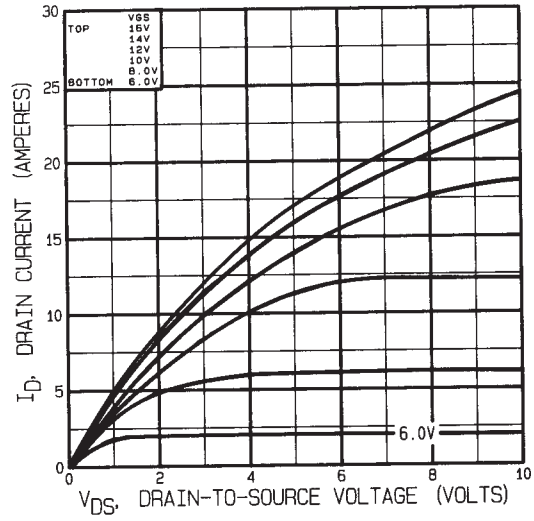

Fig 13. Typical Output Characteristics
Post-Irradiation 1 Mega Rads (Si)

IRHF7230, IRHF8230, JANSR-, JANSH-, 2N7262 Devices Radiation Characteristics

Note: Bias Conditions during radiation: $V_{GS} = 0$ Vdc, $V_{DS} = 160$ Vdc

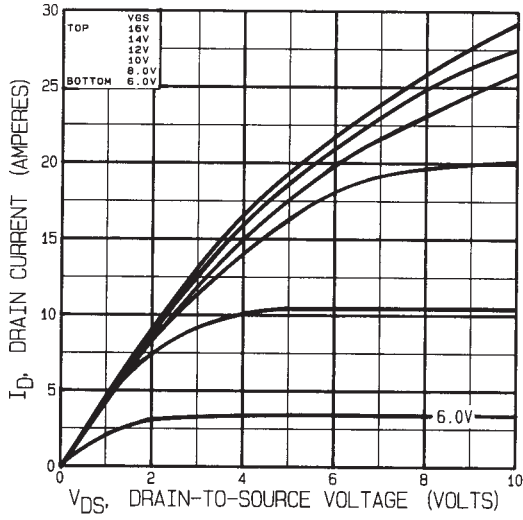

Fig 14. Typical Output Characteristics Pre-Irradiation

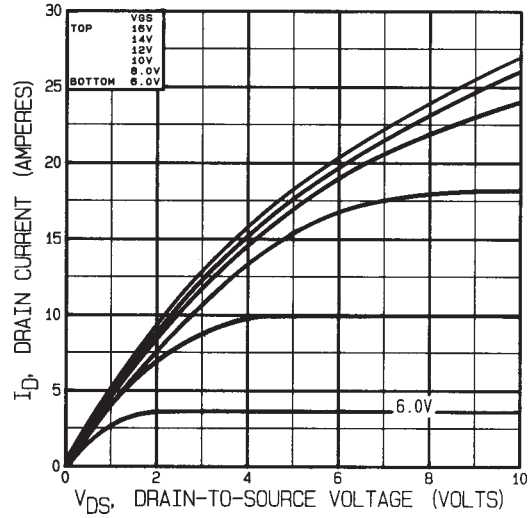

Fig 15. Typical Output Characteristics Post-Irradiation 100K Rads (Si)

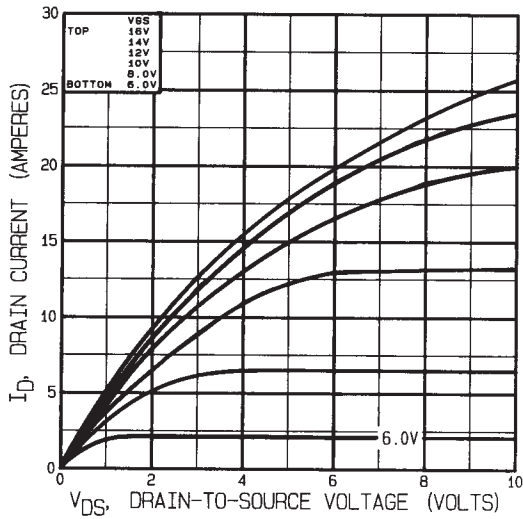

Fig 16. Typical Output Characteristics Post-Irradiation 300K Rads (Si)

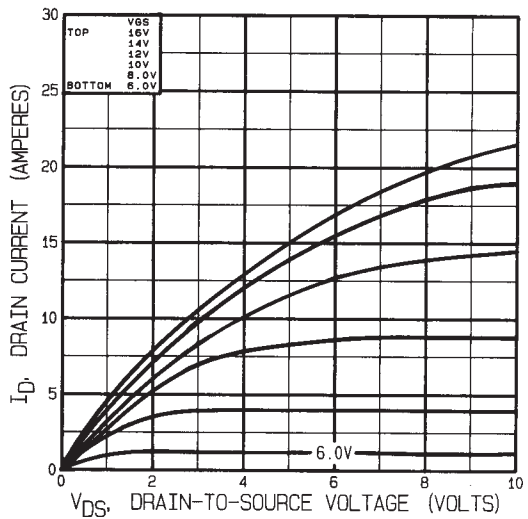

Fig 17. Typical Output Characteristics Post-Irradiation 1 Mega Rads (Si)

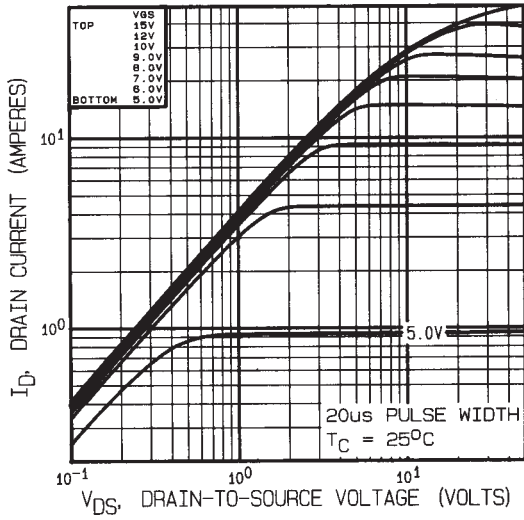

Fig 18. Typical Output Characteristics

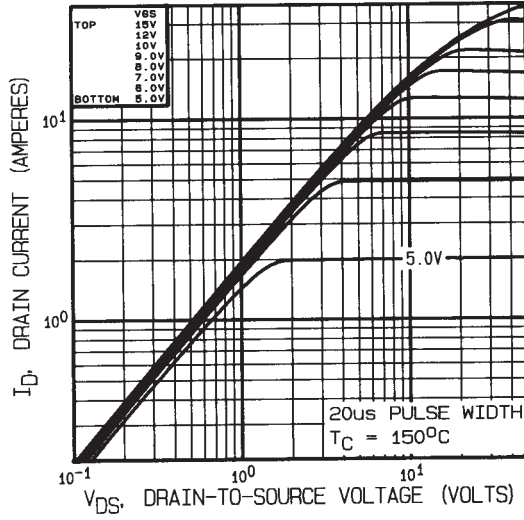

Fig 19. Typical Output Characteristics

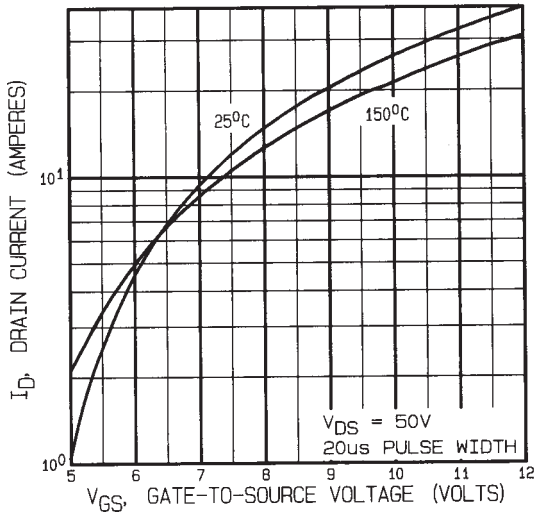

Fig 20. Typical Transfer Characteristics

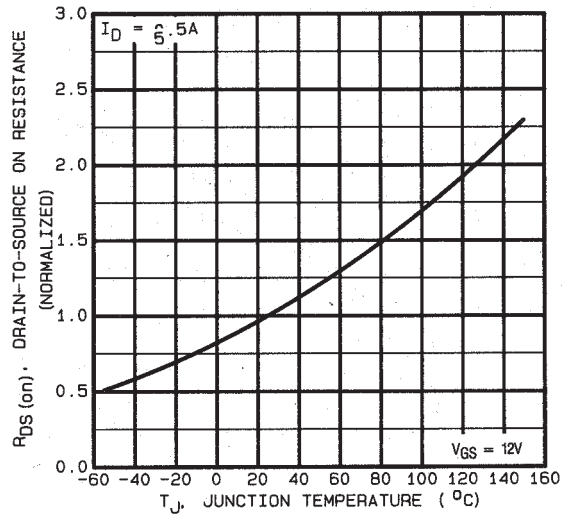

Fig 21. Normalized On-Resistance Vs. Temperature

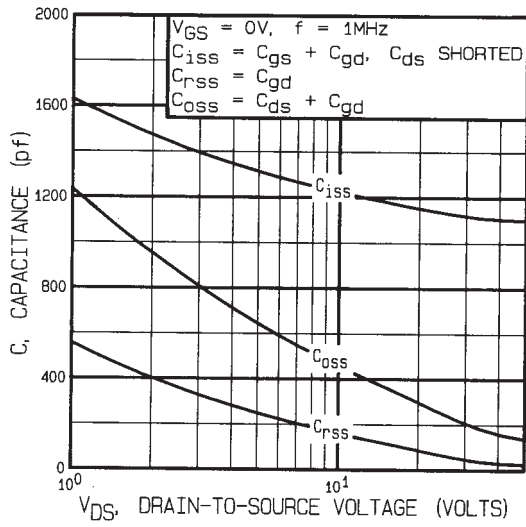

Fig 22. Typical Capacitance Vs. Drain-to-Source Voltage

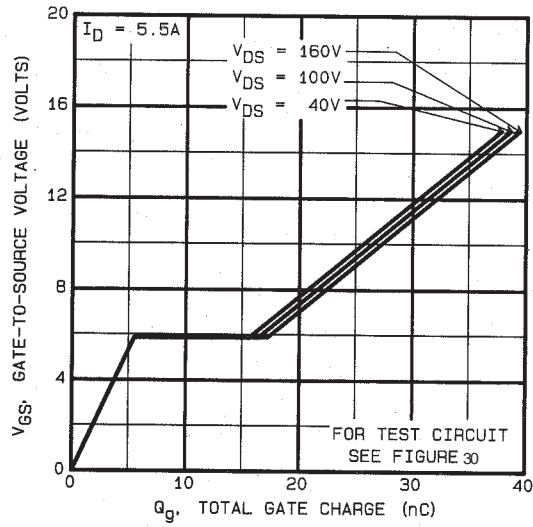

Fig 23. Typical Gate Charge Vs. Gate-to-Source Voltage

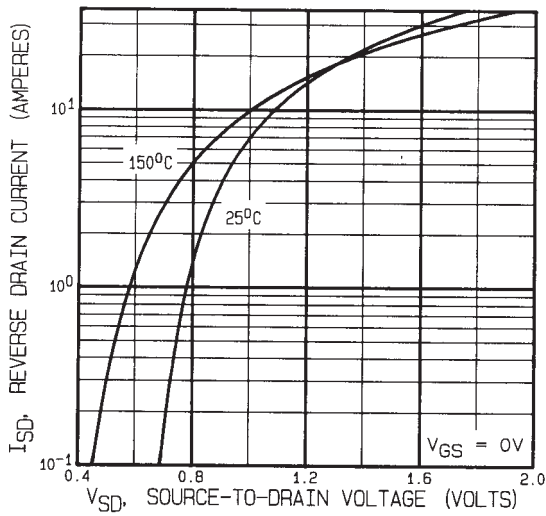

Fig 24. Typical Source-Drain Diode Forward Voltage

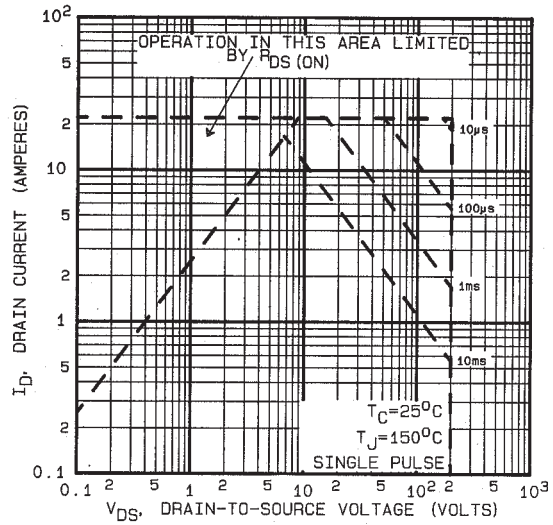

Fig 25. Maximum Safe Operating Area

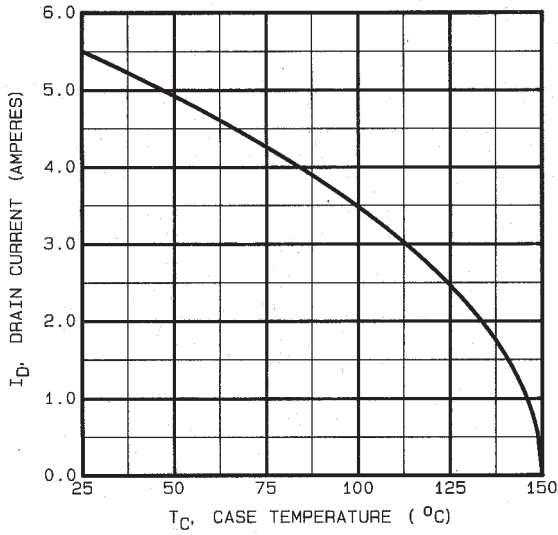

Fig 26. Maximum Drain Current Vs. Case Temperature

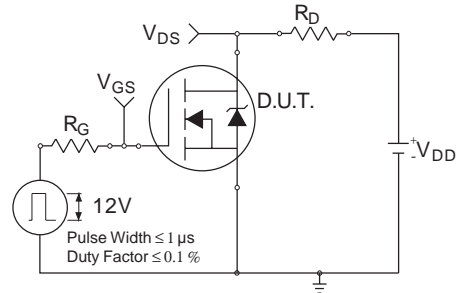

Fig 27a. Switching Time Test Circuit

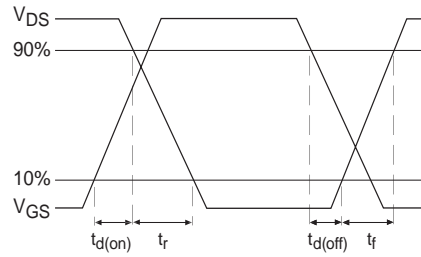

Fig 27b. Switching Time Waveforms

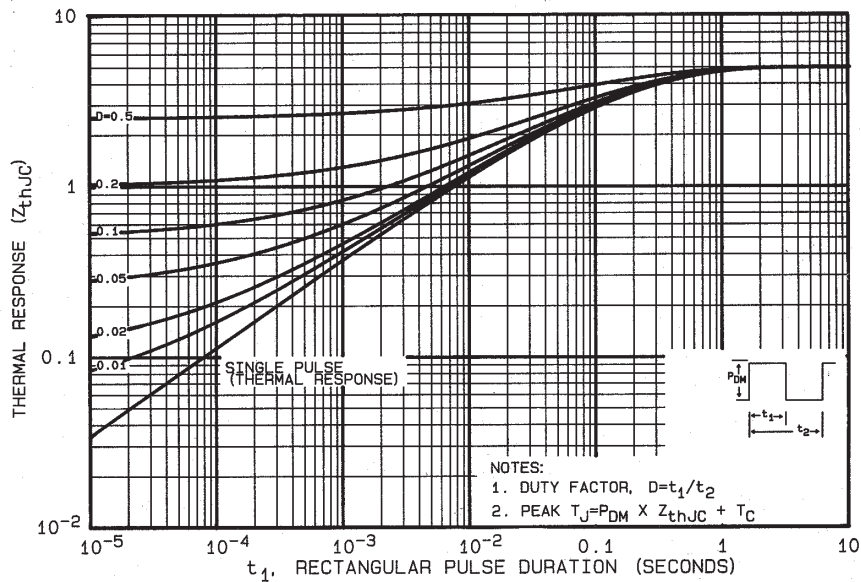

Fig 28. Maximum Effective Transient Thermal Impedance, Junction-to-Case

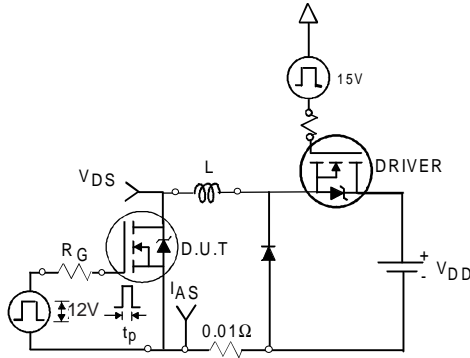

Fig 29a. Unclamped Inductive Test Circuit

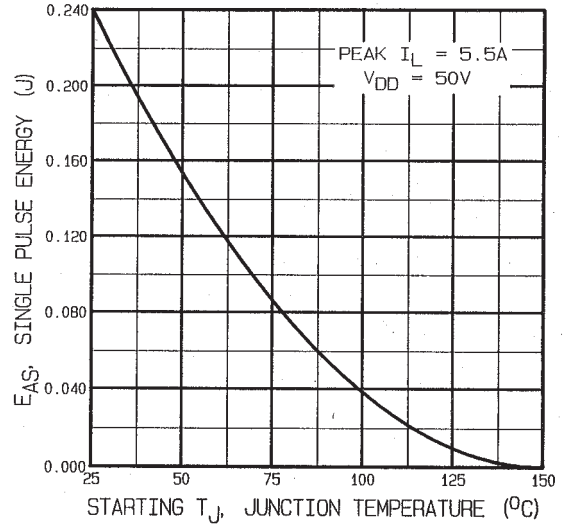

Fig 29c. Maximum Avalanche Energy Vs. Drain Current

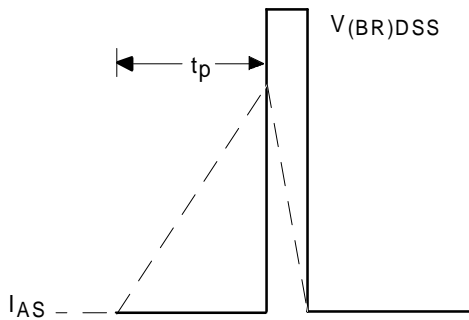

Fig 29b. Unclamped Inductive Waveforms

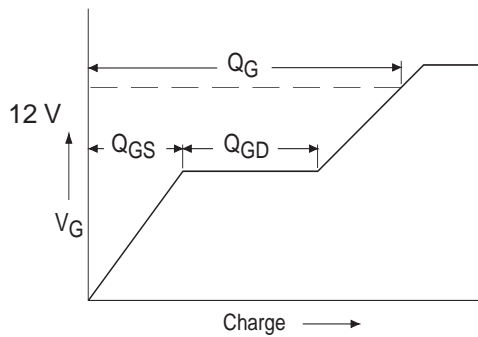

Fig30a. Basic Gate Charge Waveform

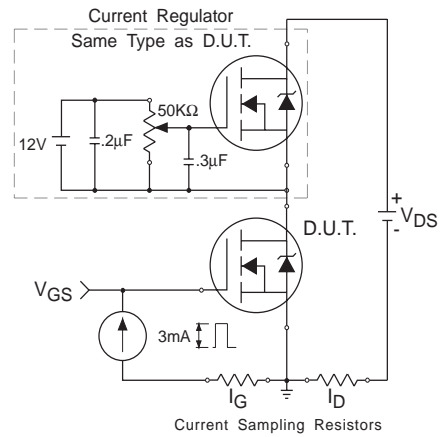

Fig 30b. Gate Charge Test Circuit

IRHF7230, IRHF8230, JANSR-, JANSH-, 2N7262 Devices

Pre-Irradiation

- ① See Figures 18 through 30 for pre-radiation curves
- ② Repetitive Rating; Pulse width limited by maximum junction temperature. Refer to current HEXFET reliability report.
- ③ $V_{DD} = 25V$, Starting $T_J = 25^\circ C$, Peak $I_L = 5.5A$, $L \geq 11mH$, $R_G = 25\Omega$
- ④ $I_{SD} \leq 5.5A$, $di/dt \leq 120A/\mu s$, $V_{DD} \leq BV_{DSS}$, $T_J \leq 150^\circ C$
Suggested $R_G = 7.5\Omega$
- ⑤ Pulse width $\leq 300 \mu s$; Duty Cycle $\leq 2\%$
- ⑥ **Total Dose Irradiation with VGS Bias.**
12 volt VGS applied and $V_{DS} = 0$ during irradiation per MIL-STD-750, method 1019, condition A.
- ⑦ **Total Dose Irradiation with VDS Bias.**
 $V_{DS} = 0.8$ rated BV_{DSS} (pre-radiation) applied and $V_{GS} = 0$ during irradiation per MIL-STD-750, method 1019, condition A.
- ⑧ This test is performed using a flash x-ray source operated in the e-beam mode (energy ~2.5 MeV), 30 nsec pulse.
- ⑨ All Pre-Irradiation and Post-Irradiation test conditions are **identical** to facilitate direct comparison for circuit applications.

Case Outline and Dimensions — TO-205AF (Modified TO-39)

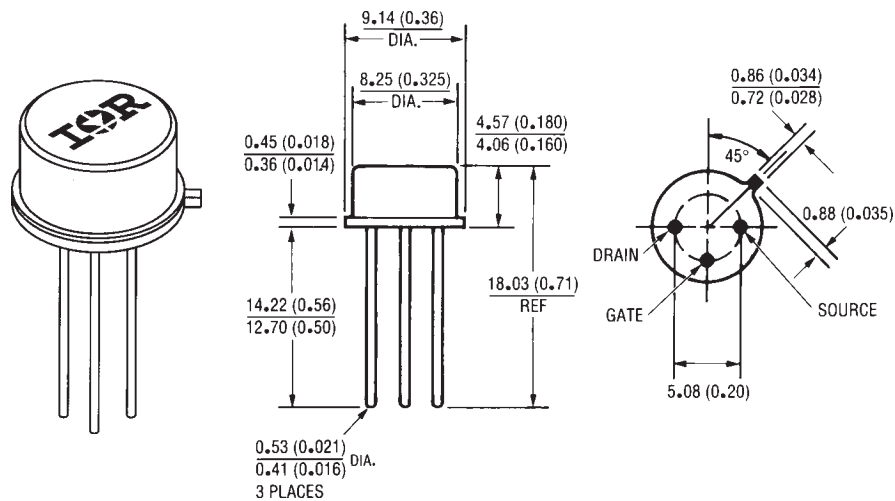

All dimensions are shown millimeters (inches)

International
IOR Rectifier

WORLD HEADQUARTERS: 233 Kansas St., El Segundo, California 90245, Tel: (310) 322 3331

IR GREAT BRITAIN: Hurst Green, Oxted, Surrey RH8 9BB, UK Tel: ++ 44 1883 732020

IR CANADA: 15 Lincoln Court, Brampton, Ontario L6T3Z2, Tel: (905) 453 2200

IR GERMANY: Saalburgstrasse 157, 61350 Bad Homburg Tel: ++ 49 6172 96590

IR ITALY: Via Liguria 49, 10071 Borgaro, Torino Tel: ++ 39 11 451 0111

IR FAR EAST: K&H Bldg., 2F, 30-4 Nishi-Ikebukuro 3-Chome, Toshima-Ku, Tokyo Japan 171 Tel: 81 3 3983 0086

IR SOUTHEAST ASIA: 1 Kim Seng Promenade, Great World City West Tower, 13-11, Singapore 237994 Tel: ++ 65 838 4630

IR TAIWAN: 16 Fl. Suite D. 207, Sec. 2, Tun Haw South Road, Taipei, 10673, Taiwan Tel: 886-2-2377-9936

<http://www.irf.com/> Data and specifications subject to change without notice. 10/98