

International  
**IR** Rectifier  
**RADIATION HARDENED**  
**POWER MOSFET**  
**SURFACE MOUNT (SMD-2)**

PD - 91860H

**IRHNA57160**  
**JANSR2N7469U2**  
**100V, N-CHANNEL**  
**REF: MIL-PRF-19500/673**



**Product Summary**

| Part Number | Radiation Level | RDS(on) | ID   | QPL Part Number |
|-------------|-----------------|---------|------|-----------------|
| IRHNA57160  | 100K Rads (Si)  | 0.012Ω  | 75*A | JANSR2N7469U2   |
| IRHNA53160  | 300K Rads (Si)  | 0.012Ω  | 75*A | JANSF2N7469U2   |
| IRHNA54160  | 600K Rads (Si)  | 0.012Ω  | 75*A | JANSG2N7469U2   |
| IRHNA58160  | 1000K Rads (Si) | 0.013Ω  | 75*A | JANSH2N7469U2   |

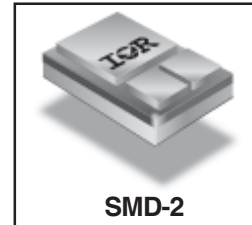

International Rectifier's R5™ technology provides high performance power MOSFETs for space applications. These devices have been characterized for Single Event Effects (SEE) with useful performance up to an LET of 80 (MeV/(mg/cm<sup>2</sup>)). The combination of low RDS(on) and low gate charge reduces the power losses in switching applications such as DC to DC converters and motor control. These devices retain all of the well established advantages of MOSFETs such as voltage control, fast switching, ease of paralleling and temperature stability of electrical parameters.

**Features:**

- Single Event Effect (SEE) Hardened
- Ultra Low RDS(on)
- Low Total Gate Charge
- Simple Drive Requirements
- Ease of Paralleling
- Hermetically Sealed
- Surface Mount
- Ceramic Package
- Light Weight

**Absolute Maximum Ratings**

**Pre-Irradiation**

|                            | Parameter                       |               | Units |
|----------------------------|---------------------------------|---------------|-------|
| ID @ VGS = 12V, TC = 25°C  | Continuous Drain Current        | 75*           | A     |
| ID @ VGS = 12V, TC = 100°C | Continuous Drain Current        | 69            |       |
| IDM                        | Pulsed Drain Current ①          | 300           |       |
| PD @ TC = 25°C             | Max. Power Dissipation          | 250           | W     |
|                            | Linear Derating Factor          | 2.0           | W/°C  |
| VGS                        | Gate-to-Source Voltage          | ±20           | V     |
| EAS                        | Single Pulse Avalanche Energy ② | 363           | mJ    |
| IAR                        | Avalanche Current ①             | 75            | A     |
| EAR                        | Repetitive Avalanche Energy ①   | 25            | mJ    |
| dv/dt                      | Peak Diode Recovery dv/dt ③     | 6.0           | V/ns  |
| TJ                         | Operating Junction              | -55 to 150    | °C    |
| TSTG                       | Storage Temperature Range       |               |       |
|                            | Pckg. Mounting Surface Temp.    | 300 (for 5s)  |       |
|                            | Weight                          | 3.3 (Typical) | g     |

\* Current is limited by package  
 For footnotes refer to the last page

**Electrical Characteristics @ T<sub>j</sub> = 25°C (Unless Otherwise Specified)**

|  | Parameter                                    | Min | Typ   | Max   | Units               | Test Conditions   |
|--|--|-----|-------|-------|---------------------|---|
| B <sub>V</sub> D <sub>SS</sub>                   | Drain-to-Source Breakdown Voltage            | 100 | —     | —     | V                   | V <sub>GS</sub> = 0V, I <sub>D</sub> = 1.0mA  |
| ΔB <sub>V</sub> D <sub>SS</sub> /ΔT <sub>J</sub> | Temperature Coefficient of Breakdown Voltage | —   | 0.115 | —     | V/°C                | Reference to 25°C, I <sub>D</sub> = 1.0mA   |
| R <sub>DS(on)</sub>                              | Static Drain-to-Source On-State Resistance   | —   | —     | 0.012 | Ω                   | V <sub>GS</sub> = 12V, I <sub>D</sub> = 69A <sup>④</sup>                                      |
| V <sub>GS(th)</sub>                              | Gate Threshold Voltage                       | 2.0 | —     | 4.0   | V                   | V <sub>DS</sub> = V <sub>GS</sub> , I <sub>D</sub> = 1.0mA                                    |
| g <sub>fs</sub>                                  | Forward Transconductance                     | 42  | —     | —     | S (r <sub>θ</sub> ) | V <sub>DS</sub> ≥ 15V, I <sub>DS</sub> = 69A <sup>④</sup>                                     |
| I <sub>DSS</sub>                                 | Zero Gate Voltage Drain Current              | —   | —     | 10    | μA                  | V <sub>DS</sub> = 80V, V <sub>GS</sub> = 0V   |
|  |  | —   | —     | 25    |                     | V <sub>DS</sub> = 80V,<br>V <sub>GS</sub> = 0V, T <sub>J</sub> = 125°C                        |
| I <sub>GSS</sub>                                 | Gate-to-Source Leakage Forward               | —   | —     | 100   | nA                  | V <sub>GS</sub> = 20V   |
| I <sub>GSS</sub>                                 | Gate-to-Source Leakage Reverse               | —   | —     | -100  |                     | V <sub>GS</sub> = -20V  |
| Q <sub>g</sub>                                   | Total Gate Charge                            | —   | —     | 160   | nC                  | V <sub>GS</sub> = 12V, I <sub>D</sub> = 45A   |
| Q <sub>gs</sub>                                  | Gate-to-Source Charge                        | —   | —     | 55    |                     | V <sub>DS</sub> = 50V   |
| Q <sub>gd</sub>                                  | Gate-to-Drain ('Miller') Charge              | —   | —     | 65    |                     |   |
| t <sub>d(on)</sub>                               | Turn-On Delay Time                           | —   | —     | 35    | ns                  | V <sub>DD</sub> = 50V, I <sub>D</sub> = 45A,<br>V <sub>GS</sub> = 12V, R <sub>G</sub> = 2.35Ω |
| t <sub>r</sub>                                   | Rise Time                                    | —   | —     | 125   |                     |   |
| t <sub>d(off)</sub>                              | Turn-Off Delay Time                          | —   | —     | 75    |                     |   |
| t <sub>f</sub>                                   | Fall Time                                    | —   | —     | 50    |                     |   |
| L <sub>S</sub> + L <sub>D</sub>                  | Total Inductance                             | —   | 4.0   | —     | nH                  | Measured from the center of drain pad to center of source pad                                 |
| C <sub>iss</sub>                                 | Input Capacitance                            | —   | 6440  | —     | pF                  | V <sub>GS</sub> = 0V, V <sub>DS</sub> = 25V<br>f = 1.0MHz                                     |
| C <sub>oss</sub>                                 | Output Capacitance                           | —   | 1660  | —     |                     |   |
| C <sub>rss</sub>                                 | Reverse Transfer Capacitance                 | —   | 60    | —     |                     |   |

**Source-Drain Diode Ratings and Characteristics**

|                 | Parameter                                      | Min  | Typ | Max | Units | Test Conditions  |
|-----------------|--|--|-----|-----|-------|--|
| I <sub>S</sub>  | Continuous Source Current (Body Diode)         | —  | —   | 75* | A     |  |
| I <sub>SM</sub> | Pulse Source Current (Body Diode) <sup>①</sup> | —  | —   | 300 |       |  |
| V <sub>SD</sub> | Diode Forward Voltage                          | —  | —   | 1.2 | V     | T <sub>j</sub> = 25°C, I <sub>S</sub> = 75A, V <sub>GS</sub> = 0V <sup>④</sup> |
| t <sub>rr</sub> | Reverse Recovery Time                          | —  | —   | 300 | nS    | T <sub>j</sub> = 25°C, I <sub>F</sub> = 45A, di/dt ≤ 100A/μs                   |
| Q <sub>RR</sub> | Reverse Recovery Charge                        | —  | —   | 2.2 | μC    | V <sub>DD</sub> ≤ 25V <sup>④</sup>   |
| t <sub>on</sub> | Forward Turn-On Time                           | Intrinsic turn-on time is negligible. Turn-on speed is substantially controlled by L <sub>S</sub> + L <sub>D</sub> . |     |     |       |  |

\* Current is limited by package

**Thermal Resistance**

|                      | Parameter            | Min | Typ | Max | Units | Test Conditions                           |
|----------------------|----------------------|-----|-----|-----|-------|---|
| R <sub>thJC</sub>    | Junction-to-Case     | —   | —   | 0.5 | °C/W  | soldered to a 2" square copper-clad board |
| R <sub>thJ-PCB</sub> | Junction-to-PC board | —   | 1.6 | —   |       |   |

**Note:** Corresponding Spice and Saber models are available on International Rectifier Web site.

For footnotes refer to the last page

## Radiation Characteristics

## IRHNA57160, JANSR2N7469U2

International Rectifier Radiation Hardened MOSFETs are tested to verify their radiation hardness capability. The hardness assurance program at International Rectifier is comprised of two radiation environments. Every manufacturing lot is tested for total ionizing dose (per notes 5 and 6) using the TO-3 package. Both pre- and post-irradiation performance are tested and specified using the same drive circuitry and test conditions in order to provide a direct comparison.

**Table 1. Electrical Characteristics @ Tj = 25°C, Post Total Dose Irradiation** ⑤⑥

|                     | Parameter                         | Up to 600K Rads(Si) <sup>1</sup> |       | 1000K Rads (Si) <sup>2</sup> |       | Units | Test Conditions  |
|---------------------|-----------------------------------|----------------------------------|-------|------------------------------|-------|-------|--|
|                     |                                   | Min                              | Max   | Min                          | Max   |       |  |
| BV <sub>DSS</sub>   | Drain-to-Source Breakdown Voltage | 100                              | —     | 100                          | —     | V     | V <sub>GS</sub> = 0V, I <sub>D</sub> = 1.0mA               |
| V <sub>GS(th)</sub> | Gate Threshold Voltage            | 2.0                              | 4.0   | 1.5                          | 4.0   |       | V <sub>GS</sub> = V <sub>DS</sub> , I <sub>D</sub> = 1.0mA |
| I <sub>GS</sub>     | Gate-to-Source Leakage Forward    | —                                | 100   | —                            | 100   | nA    | V <sub>GS</sub> = 20V                                      |
| I <sub>GS</sub>     | Gate-to-Source Leakage Reverse    | —                                | -100  | —                            | -100  |       | V <sub>GS</sub> = -20 V                                    |
| I <sub>DSS</sub>    | Zero Gate Voltage Drain Current   | —                                | 10    | —                            | 25    | μA    | V <sub>DS</sub> =80V, V <sub>GS</sub> =0V                  |
| R <sub>DS(on)</sub> | Static Drain-to-Source ④          | —                                | 0.013 | —                            | 0.014 | Ω     | V <sub>GS</sub> = 12V, I <sub>D</sub> = 45A                |
|                     | On-State Resistance (TO-3)        |                                  |       |                              |       |       |  |
| R <sub>DS(on)</sub> | Static Drain-to-Source ④          | —                                | 0.012 | —                            | 0.013 | Ω     | V <sub>GS</sub> = 12V, I <sub>D</sub> = 45A                |
|                     | On-State Resistance (SMD-2)       |                                  |       |                              |       |       |  |
| V <sub>SD</sub>     | Diode Forward Voltage ④           | —                                | 1.2   | —                            | 1.2   | V     | V <sub>GS</sub> = 0V, I <sub>S</sub> = 45A                 |

1. Part numbers IRHNA57160 ( JANSR2N7469U2 ), IRHNA53160 ( JANSF2N7469U2 ) and IRHNA54160 ( JANSR2N7469U2 )

2. Part number IRHNA58160 ( JANSR2N7469U2 )

International Rectifier radiation hardened MOSFETs have been characterized in heavy ion environment for Single Event Effects (SEE). Single Event Effects characterization is illustrated in Fig. a and Table 2.

**Table 2. Single Event Effect Safe Operating Area**

| Ion | LET<br>MeV/(mg/cm <sup>2</sup> ) | Energy<br>(MeV) | Range<br>(μm) | V <sub>DS</sub> (V)  |                       |                        |                        |                        |
|-----|----------------------------------|-----------------|---------------|----------------------|-----------------------|------------------------|------------------------|------------------------|
|     |                                  |                 |               | @V <sub>GS</sub> =0V | @V <sub>GS</sub> =-5V | @V <sub>GS</sub> =-10V | @V <sub>GS</sub> =-15V | @V <sub>GS</sub> =-20V |
| Br  | 36.7                             | 309             | 39.5          | 100                  | 100                   | 100                    | 100                    | 100                    |
| I   | 59.8                             | 341             | 32.5          | 100                  | 100                   | 100                    | 35                     | 25                     |
| Au  | 82.3                             | 350             | 28.4          | 100                  | 100                   | 80                     | 25                     | —                      |

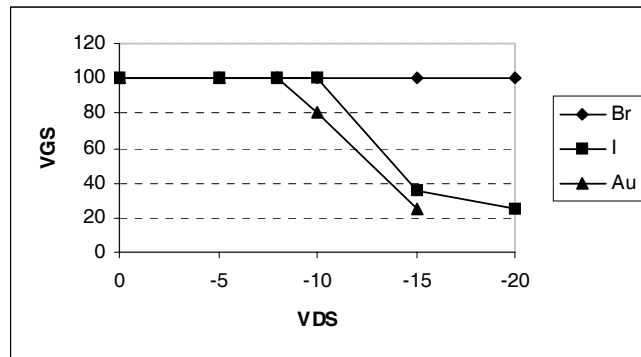

**Fig a. Single Event Effect, Safe Operating Area**

For footnotes refer to the last page

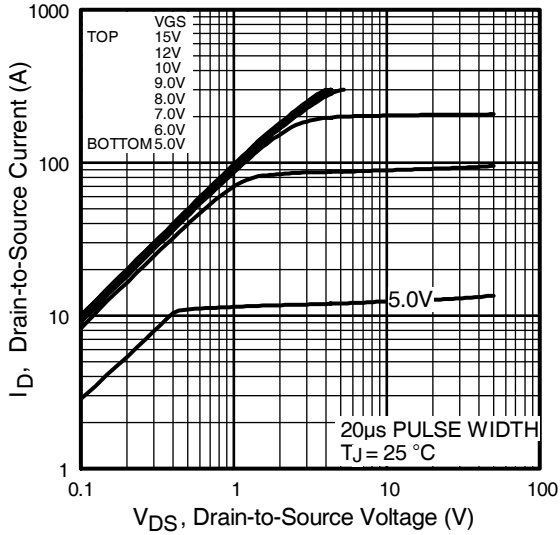

Fig 1. Typical Output Characteristics

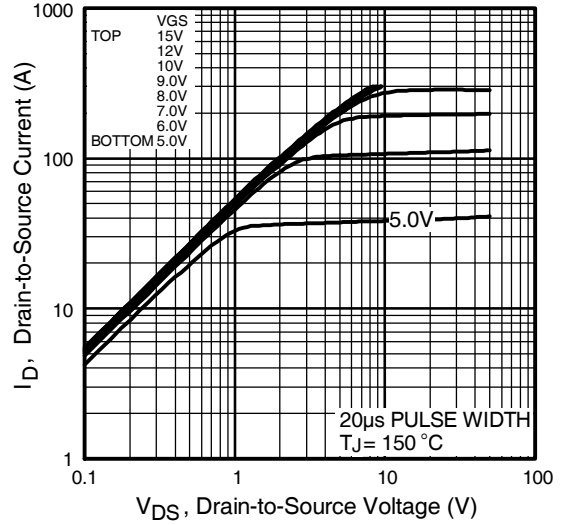

Fig 2. Typical Output Characteristics

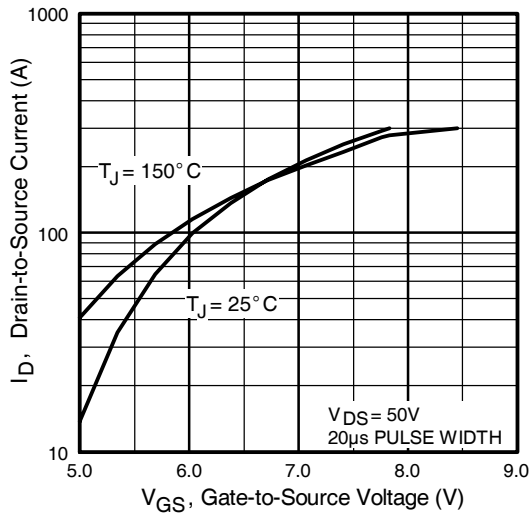

Fig 3. Typical Transfer Characteristics

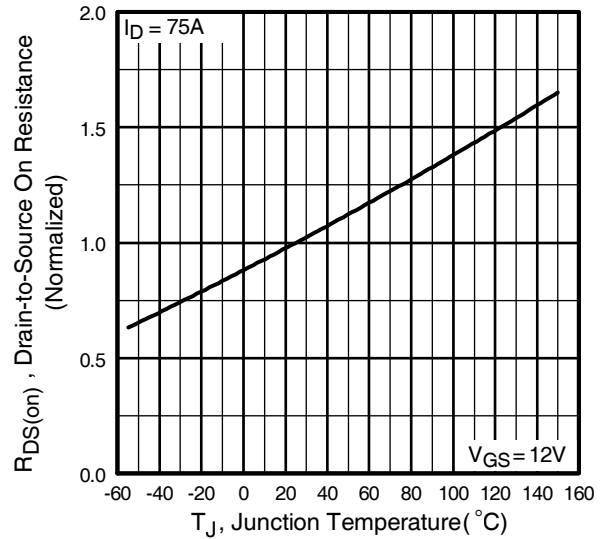

Fig 4. Normalized On-Resistance Vs. Temperature

Pre-Irradiation

IRHNA57160, JANSR2N7469U2

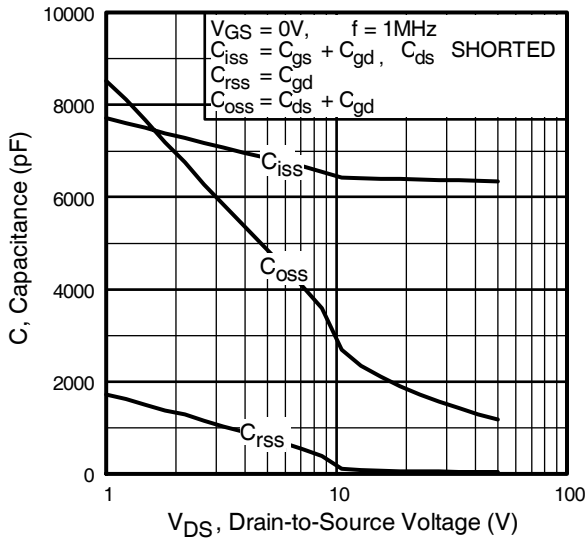

Fig 5. Typical Capacitance Vs. Drain-to-Source Voltage

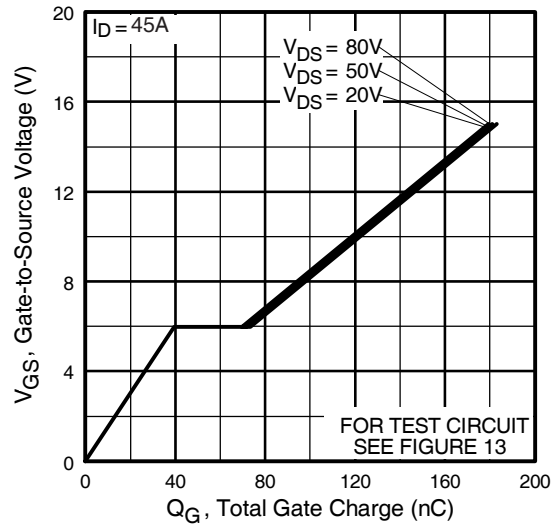

Fig 6. Typical Gate Charge Vs. Gate-to-Source Voltage

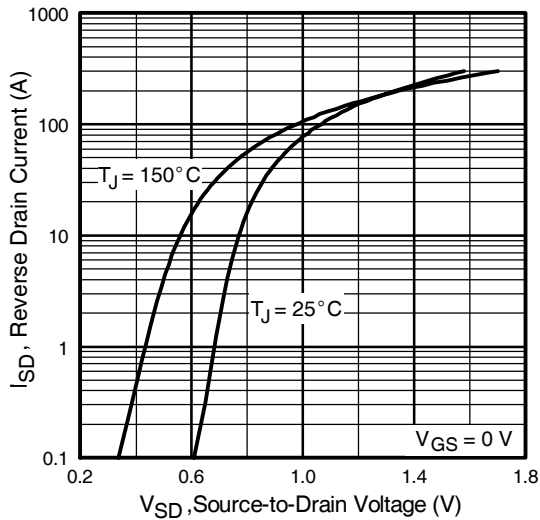

Fig 7. Typical Source-Drain Diode Forward Voltage

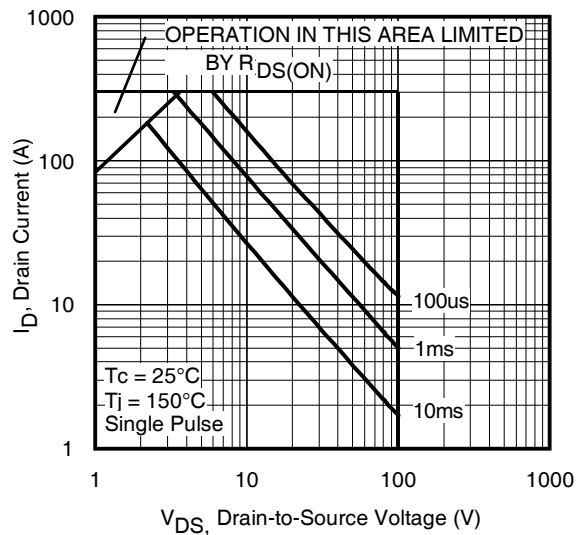

Fig 8. Maximum Safe Operating Area

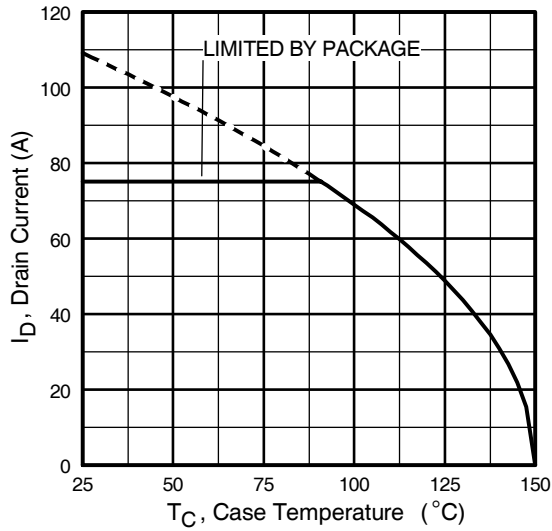

Fig 9. Maximum Drain Current Vs. Case Temperature

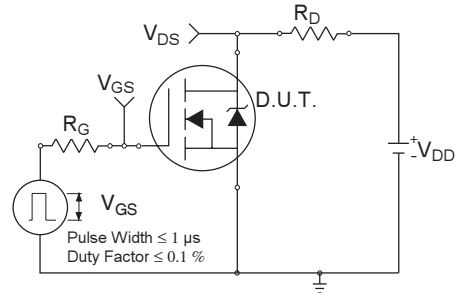

Fig 10a. Switching Time Test Circuit

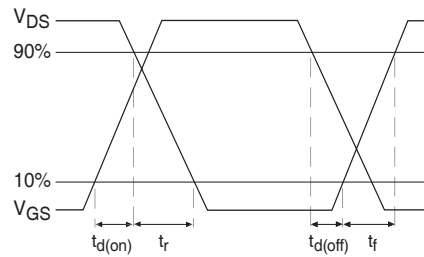

Fig 10b. Switching Time Waveforms

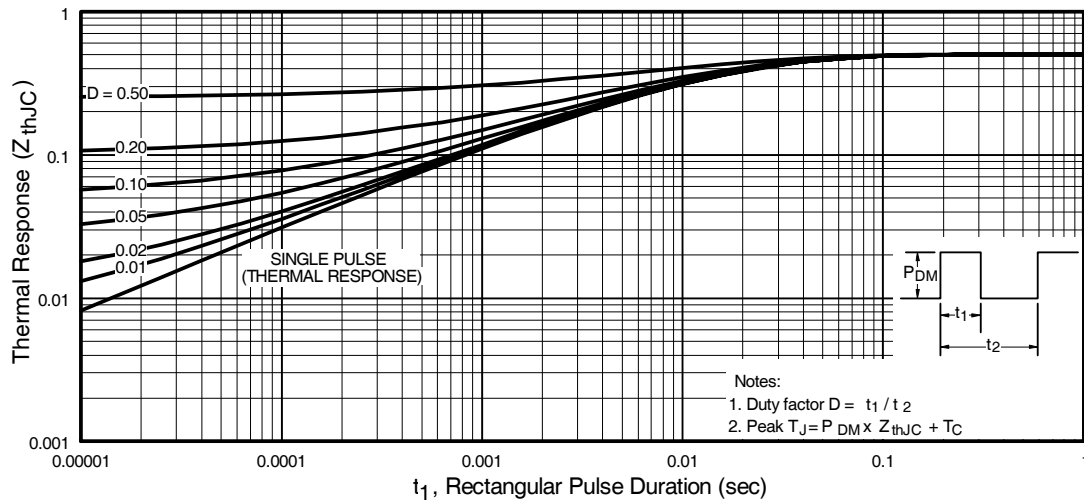

Fig 11. Maximum Effective Transient Thermal Impedance, Junction-to-Case

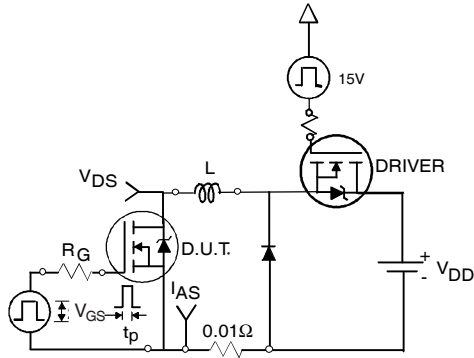

Fig 12a. Unclamped Inductive Test Circuit

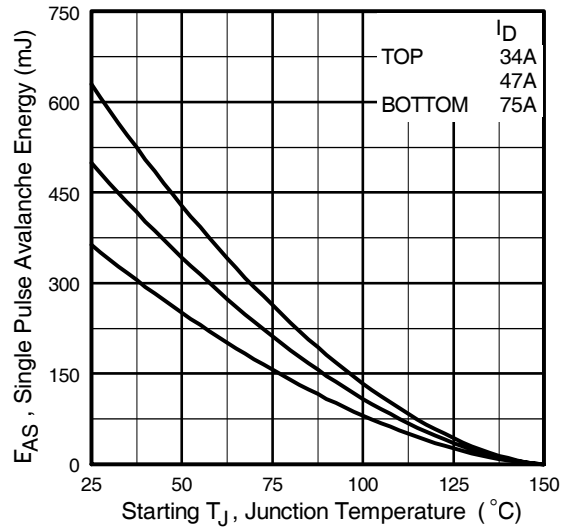

Fig 12c. Maximum Avalanche Energy Vs. Drain Current

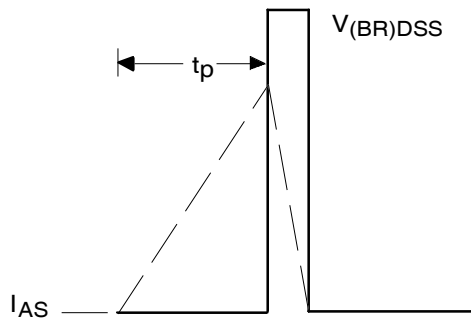

Fig 12b. Unclamped Inductive Waveforms

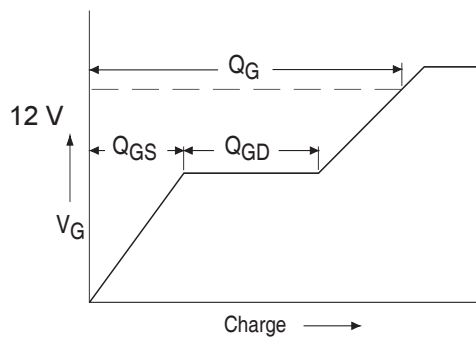

Fig 13a. Basic Gate Charge Waveform

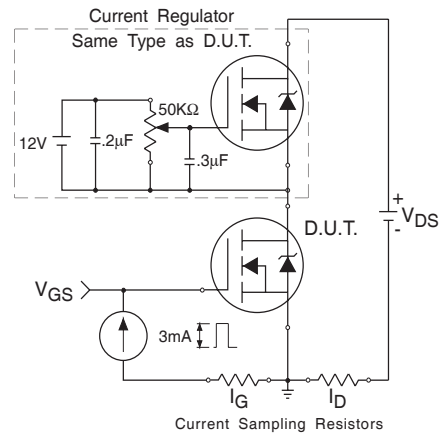
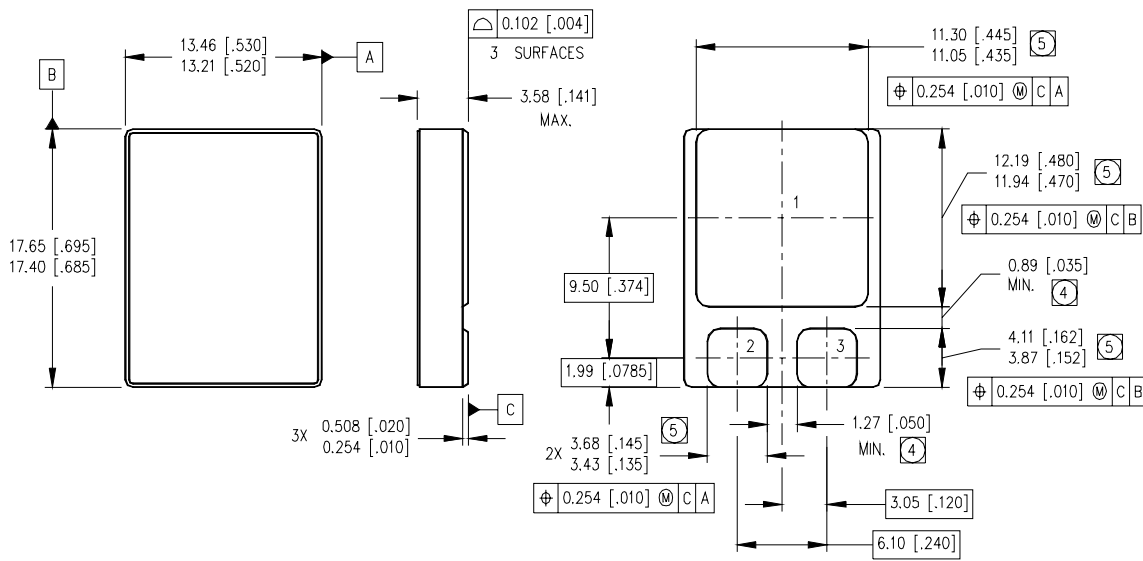

Fig 13b. Gate Charge Test Circuit

**Footnotes:**

- ① Repetitive Rating; Pulse width limited by maximum junction temperature.
- ②  $V_{DD} = 50V$ , starting  $T_J = 25^\circ C$ ,  $L = 0.13mH$   
Peak  $I_L = 75A$ ,  $V_{GS} = 12V$
- ③  $ISD \leq 75A$ ,  $di/dt \leq 340A/\mu s$ ,  
 $V_{DD} \leq 100V$ ,  $T_J \leq 150^\circ C$
- ④ Pulse width  $\leq 300 \mu s$ ; Duty Cycle  $\leq 2\%$
- ⑤ **Total Dose Irradiation with  $V_{GS}$  Bias.**  
12 volt  $V_{GS}$  applied and  $V_{DS} = 0$  during irradiation per MIL-STD-750, method 1019, condition A.
- ⑥ **Total Dose Irradiation with  $V_{DS}$  Bias.**  
80 volt  $V_{DS}$  applied and  $V_{GS} = 0$  during irradiation per MIL-STD-750, method 1019, condition A.

**Case Outline and Dimensions — SMD-2**



NOTES:

- 1. DIMENSIONING & TOLERANCING PER ASME Y14.5M-1994.
- 2. CONTROLLING DIMENSION: INCH.
- 3. DIMENSIONS ARE SHOWN IN MILLIMETERS [INCHES].
- ④ DIMENSION INCLUDES METALLIZATION FLASH.
- ⑤ DIMENSION DOES NOT INCLUDE METALLIZATION FLASH.

PAD ASSIGNMENTS

- 1 = DRAIN
- 2 = GATE
- 3 = SOURCE

International  
**IR** Rectifier

**IR WORLD HEADQUARTERS:** 233 Kansas St., El Segundo, California 90245, USA Tel: (310) 252-7105  
**IR LEOMINSTER :** 205 Crawford St., Leominster, Massachusetts 01453, USA Tel: (978) 534-5776  
TAC Fax: (310) 252-7903

Visit us at [www.irf.com](http://www.irf.com) for sales contact information.  
Data and specifications subject to change without notice. 06/2004