

International
IR Rectifier
RADIATION HARDENED
POWER MOSFET
THRU-HOLE (Low-Ohmic TO-254AA)

PD - 95840

IRHMS57163SE
JANSR2N7475T1
130V, N-CHANNEL
REF: MIL-PRF-19500/685



Product Summary

Part Number	Radiation Level	R _{DS(on)}	ID	QPL Part Number
IRHMS57163SE	100K Rads (Si)	0.0145Ω	45A*	JANSR2N7475T1



International Rectifier's R5™ technology provides high performance power MOSFETs for space applications. These devices have been characterized for Single Event Effects (SEE) with useful performance up to an LET of 80 (MeV/(mg/cm²)). The combination of low R_{DS(on)} and low gate charge reduces the power losses in switching applications such as DC to DC converters and motor control. These devices retain all of the well established advantages of MOSFETs such as voltage control, fast switching, ease of paralleling and temperature stability of electrical parameters.

Features:

- Low R_{DS(on)}
- Fast Switching
- Single Event Effect (SEE) Hardened
- Low Total Gate Charge
- Simple Drive Requirements
- Ease of Paralleling
- Hermetically Sealed
- Ceramic Eyelets
- Electrically Isolated
- Light Weight

Absolute Maximum Ratings

Pre-Irradiation

	Parameter		Units
I _D @ V _{GS} = 12V, T _C = 25°C	Continuous Drain Current	45*	A
I _D @ V _{GS} = 12V, T _C = 100°C	Continuous Drain Current	45*	
I _{DM}	Pulsed Drain Current ①	180	
P _D @ T _C = 25°C	Max. Power Dissipation	208	W
	Linear Derating Factor	1.67	W/°C
V _{GS}	Gate-to-Source Voltage	±20	V
EAS	Single Pulse Avalanche Energy ②	432	mJ
I _{AR}	Avalanche Current ①	45	A
E _{AR}	Repetitive Avalanche Energy ①	20.8	mJ
dv/dt	Peak Diode Recovery dv/dt ③	11.3	V/ns
T _J	Operating Junction	-55 to 150	°C
T _{STG}	Storage Temperature Range		
	Lead Temperature	300 (0.063 in.(1.6 mm from case for 10s))	
	Weight	9.3 (Typical)	g

* Current is limited by package
 For footnotes refer to the last page

Electrical Characteristics @ T_j = 25°C (Unless Otherwise Specified)

	Parameter	Min	Typ	Max	Units	Test Conditions
BV _{DSS}	Drain-to-Source Breakdown Voltage	130	—	—	V	V _{GS} = 0V, I _D = 1.0mA
ΔBV _{DSS} /ΔT _J	Temperature Coefficient of Breakdown Voltage	—	0.16	—	V/°C	Reference to 25°C, I _D = 1.0mA
R _{DSON}	Static Drain-to-Source On-State Resistance	—	—	0.0145	Ω	V _{GS} = 12V, I _D = 45A ④
V _{GS(th)}	Gate Threshold Voltage	2.5	—	4.5	V	V _{DS} = V _{GS} , I _D = 1.0mA
g _{fs}	Forward Transconductance	36	—	—	S (Ω)	V _{DS} = 15V, I _{DS} = 45A ④
I _{DSS}	Zero Gate Voltage Drain Current	—	—	10	μA	V _{DS} = 104V, V _{GS} = 0V
		—	—	25		V _{DS} = 104V, V _{GS} = 0V, T _J = 125°C
I _{GSS}	Gate-to-Source Leakage Forward	—	—	100	nA	V _{GS} = 20V
I _{GSS}	Gate-to-Source Leakage Reverse	—	—	-100		V _{GS} = -20V
Q _g	Total Gate Charge	—	—	160	nC	V _{GS} = 12V, I _D = 45A
Q _{gs}	Gate-to-Source Charge	—	—	55		V _{DS} = 65V
Q _{gd}	Gate-to-Drain ('Miller') Charge	—	—	75		
t _{d(on)}	Turn-On Delay Time	—	—	35	ns	V _{DD} = 65V, I _D = 45A
t _r	Rise Time	—	—	125		V _{GS} = 12V, R _G = 2.35Ω
t _{d(off)}	Turn-Off Delay Time	—	—	80		
t _f	Fall Time	—	—	50		
LS + LD	Total Inductance	—	6.8	—	nH	Measured from Drain lead (6mm /0.25in. from package) to Source lead (6mm /0.25in. from package) with Source wires internally bonded from Source Pin to Drain Pad
C _{iss}	Input Capacitance	—	5510	—	pF	V _{GS} = 0V, V _{DS} = 25V
C _{oss}	Output Capacitance	—	1490	—		f = 1.0MHz
C _{rss}	Reverse Transfer Capacitance	—	77	—		
R _g	Internal Gate Resistance	—	1.8	—		Ω

Source-Drain Diode Ratings and Characteristics

	Parameter	Min	Typ	Max	Units	Test Conditions
I _S	Continuous Source Current (Body Diode)	—	—	45*	A	
I _{SM}	Pulse Source Current (Body Diode) ①	—	—	180		
V _{SD}	Diode Forward Voltage	—	—	1.2	V	T _j = 25°C, I _S = 45A, V _{GS} = 0V ④
t _{rr}	Reverse Recovery Time	—	—	300	ns	T _j = 25°C, I _F = 45A, di/dt ≤ 100A/μs
Q _{RR}	Reverse Recovery Charge	—	—	3.1	μC	V _{DD} ≤ 25V ④
t _{on}	Forward Turn-On Time	Intrinsic turn-on time is negligible. Turn-on speed is substantially controlled by LS + LD.				

* Current is limited by package

Thermal Resistance

	Parameter	Min	Typ	Max	Units	Test Conditions
R _{thJC}	Junction-to-Case	—	—	0.60	°C/W	
R _{thCS}	Case-to-Sink	—	0.21	—		
R _{thJA}	Junction-to-Ambient	—	—	48		Typical socket mount

Note: Corresponding Spice and Saber models are available on International Rectifier Web site.

For footnotes refer to the last page

Radiation Characteristics

IRHMS57163SE, JANSR2N7475T1

International Rectifier Radiation Hardened MOSFETs are tested to verify their radiation hardness capability. The hardness assurance program at International Rectifier is comprised of two radiation environments. Every manufacturing lot is tested for total ionizing dose (per notes 5 and 6) using the TO-3 package. Both pre- and post-irradiation performance are tested and specified using the same drive circuitry and test conditions in order to provide a direct comparison.

Table 1. Electrical Characteristics @ Tj = 25°C, Post Total Dose Irradiation ⑤⑥

	Parameter	100K Rads (Si)		Units	Test Conditions ③
		Min	Max		
BV _{DSS}	Drain-to-Source Breakdown Voltage	130	—	V	V _{GS} = 0V, I _D = 1.0mA
V _{GS(th)}	Gate Threshold Voltage	2.0	4.5		V _{GS} = V _{DS} , I _D = 1.0mA
I _{GSS}	Gate-to-Source Leakage Forward	—	100	nA	V _{GS} = 20V
I _{GSS}	Gate-to-Source Leakage Reverse	—	-100		V _{GS} = -20V
I _{DSS}	Zero Gate Voltage Drain Current	—	10	μA	V _{DS} =104V, V _{GS} =0V
R _{DS(on)}	Static Drain-to-Source ④				
	On-State Resistance (TO-3)	—	0.0140	Ω	V _{GS} = 12V, I _D = 45A
R _{DS(on)}	Static Drain-to-Source On-state ④ Resistance (Low-Ohmic TO-254)	—	0.0145	Ω	V _{GS} = 12V, I _D = 45A
V _{SD}	Diode Forward Voltage ④	—	1.2	V	V _{GS} = 0V, I _D = 45A

International Rectifier radiation hardened MOSFETs have been characterized in heavy ion environment for Single Event Effects (SEE). Single Event Effects characterization is illustrated in Fig. a and Table 2.

Table 2. Single Event Effect Safe Operating Area

Ion	LET MeV/(mg/cm ²)	Energy (MeV)	Range (μm)	V _{DS} (V)				
				@V _{GS} =0V	@V _{GS} =-5V	@V _{GS} =-10V	@V _{GS} =-15V	@V _{GS} =-20V
Br	36.7	309	39.5	130	130	130	130	130
I	59.8	341	32.5	130	130	130	100	50
Au	82.3	350	28.4	130	120	30	—	—

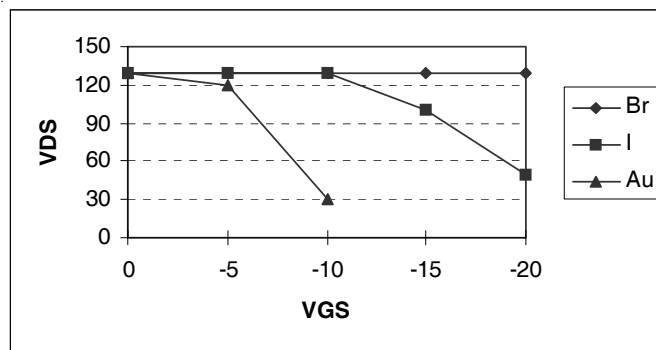

Fig a. Single Event Effect, Safe Operating Area

For footnotes refer to the last page

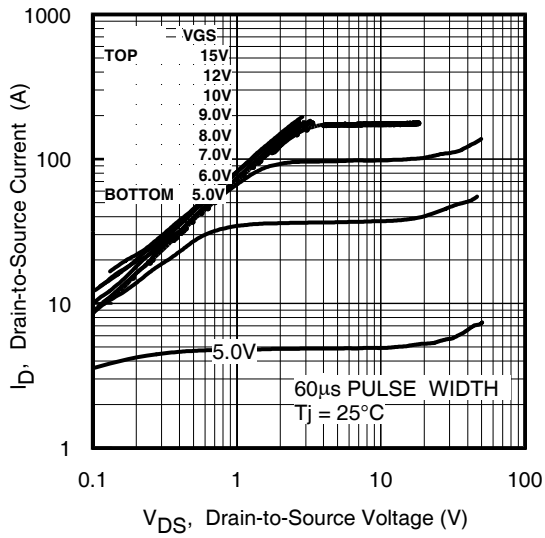

Fig 1. Typical Output Characteristics

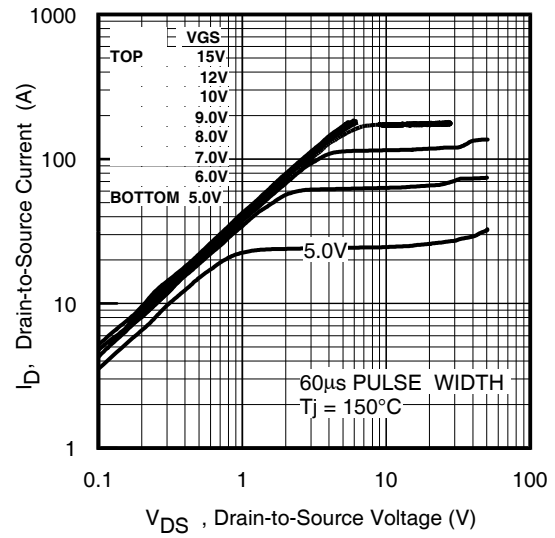

Fig 2. Typical Output Characteristics

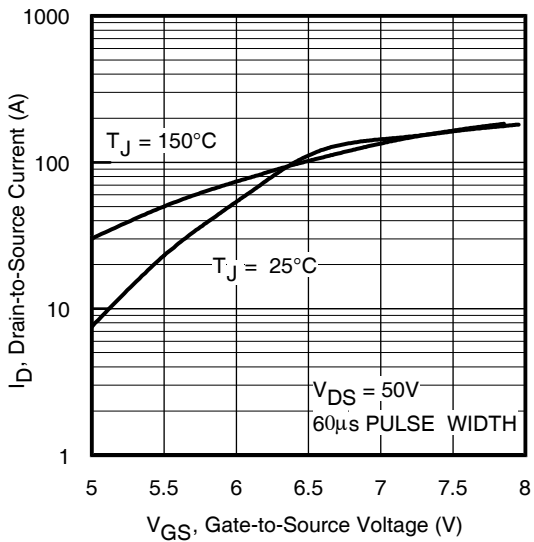

Fig 3. Typical Transfer Characteristics

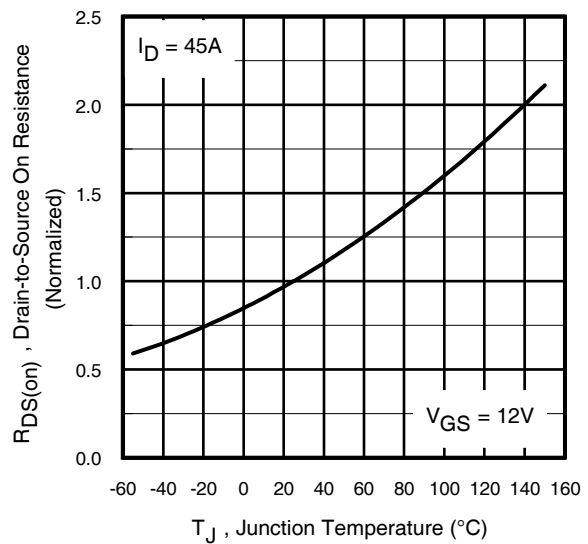

Fig 4. Normalized On-Resistance Vs. Temperature

Pre-Irradiation

IRHMS57163SE, JANSR2N7475T1

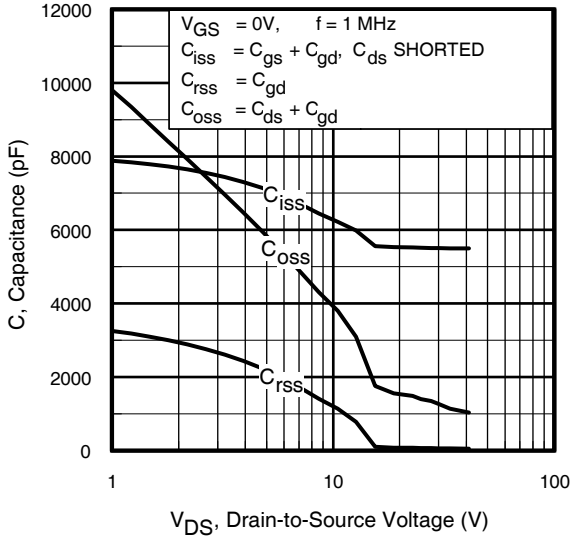

Fig 5. Typical Capacitance Vs. Drain-to-Source Voltage

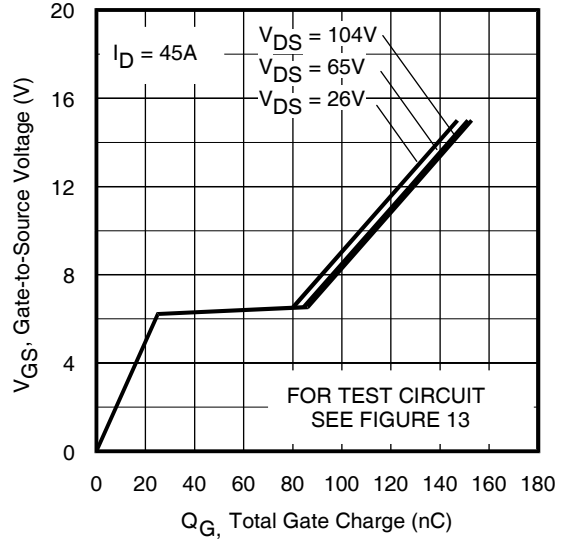

Fig 6. Typical Gate Charge Vs. Gate-to-Source Voltage

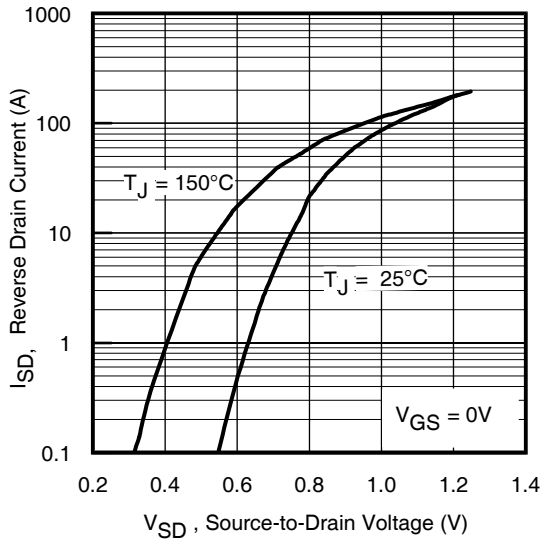

Fig 7. Typical Source-Drain Diode Forward Voltage

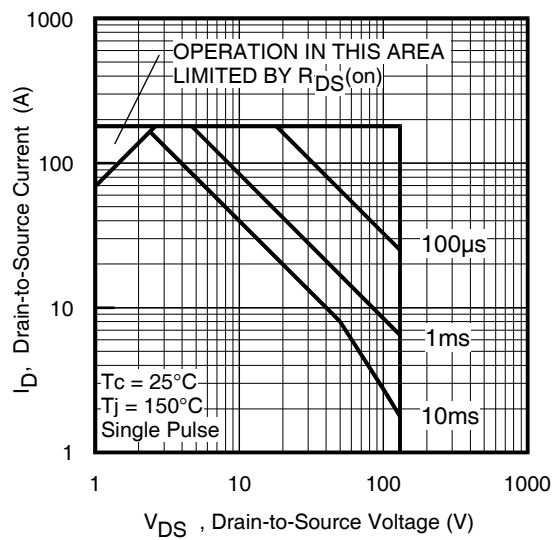

Fig 8. Maximum Safe Operating Area

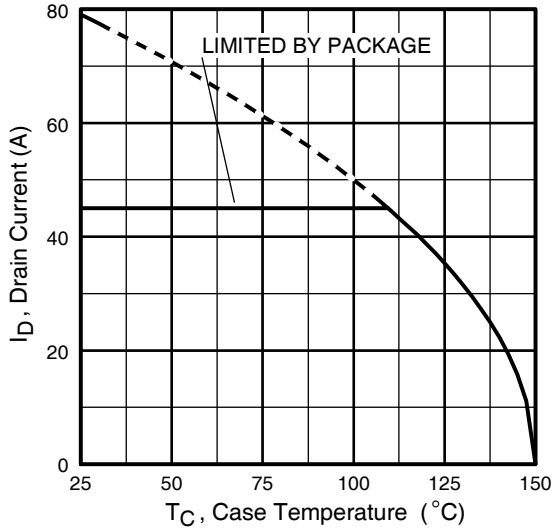

Fig 9. Maximum Drain Current Vs. Case Temperature

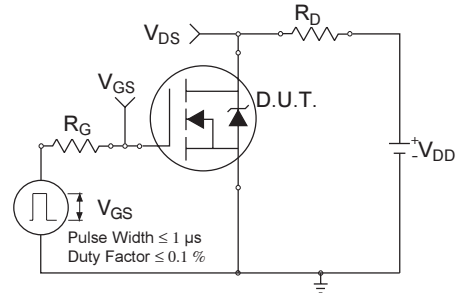

Fig 10a. Switching Time Test Circuit

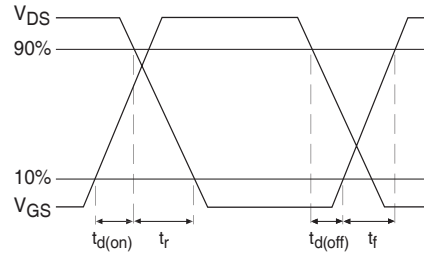

Fig 10b. Switching Time Waveforms

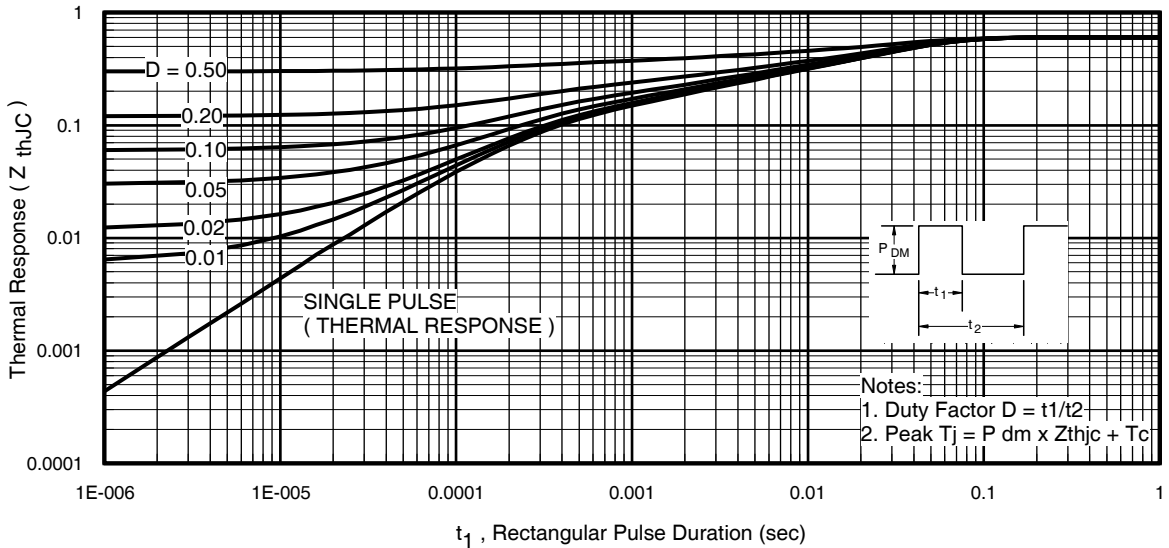

Fig 11. Maximum Effective Transient Thermal Impedance, Junction-to-Case

Pre-Irradiation

IRHMS57163SE, JANSR2N7475T1

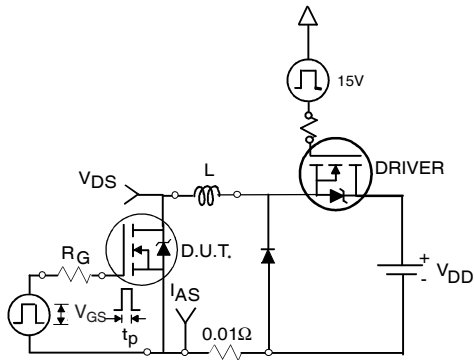

Fig 12a. Unclamped Inductive Test Circuit

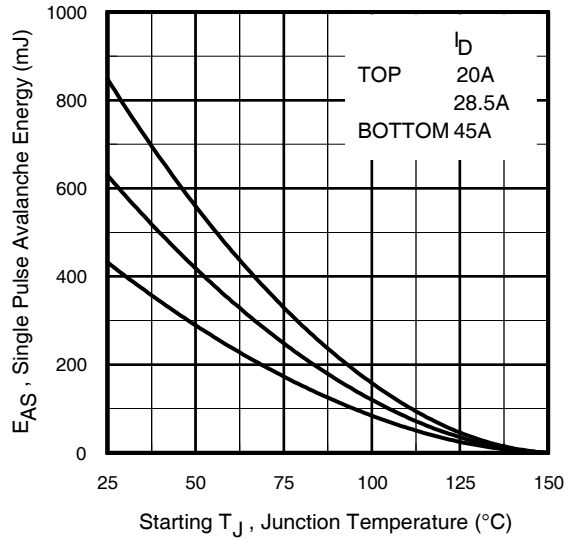

Fig 12c. Maximum Avalanche Energy Vs. Drain Current

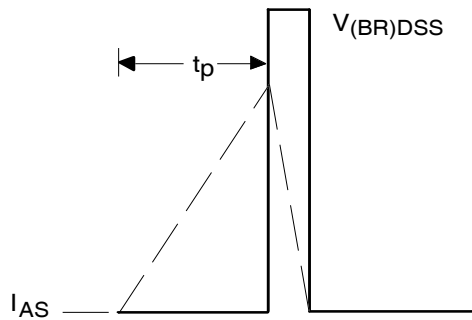

Fig 12b. Unclamped Inductive Waveforms

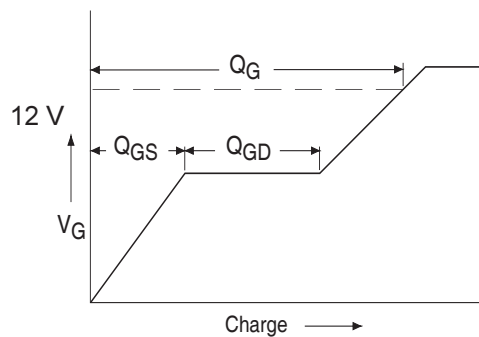

Fig 13a. Basic Gate Charge Waveform

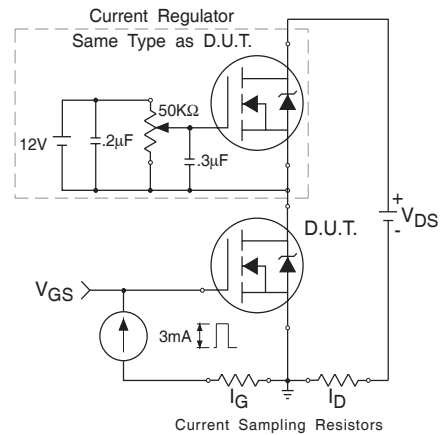

Fig 13b. Gate Charge Test Circuit

