

# International IOR Rectifier HEXFET® POWER MOSFET

Provisional Data Sheet No. PD 9.1290B

## IRFY340CM

N-CHANNEL

### 400 Volt, 0.55Ω HEXFET

HEXFET technology is the key to International Rectifier's advanced line of power MOSFET transistors. The efficient geometry design achieves very low on-state resistance combined with high transconductance.

HEXFET transistors also feature all of the well-established advantages of MOSFETs, such as voltage control, very fast switching, ease of paralleling and electrical parameter temperature stability. They are well-suited for applications such as switching power supplies, motor controls, inverters, choppers, audio amplifiers, high energy pulse circuits, and virtually any application where high reliability is required.

The HEXFET transistor's totally isolated package eliminates the need for additional isolating material between the device and the heatsink. This improves thermal efficiency and reduces drain capacitance.

### Product Summary

Part Number	BVDSS	RDS(on)	ID
IRFY340CM	400V	0.55Ω	8.7A

### Features

- Hermetically Sealed
- Electrically Isolated
- Simple Drive Requirements
- Ease of Paralleling
- Ceramic Eyelets

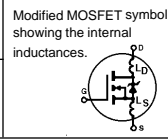
### Absolute Maximum Ratings

	Parameter	IRFY340CM	Units
ID @ VGS=10V, TC = 25°C	Continuous Drain Current	8.7	A
ID @ VGS=10V, TC = 100°C	Continuous Drain Current	5.5	
IDM	Pulsed Drain Current ①	35	
PD @ TC = 25°C	Max. Power Dissipation	100	W
	Linear Derating Factor	0.8	W/K ⑤
VGS	Gate-to-Source Voltage	±20	V
EAS	Single Pulse Avalanche Energy ②	520	mJ
IAR	Avalanche Current ①	8.7	A
EAR	Repetitive Avalanche Energy ①	10	mJ
dv/dt	Peak Diode Recovery dv/dt ③	4.0	V/ns
TJ	Operating Junction	-55 to 150	°C
Tstg	Storage Temperature Range		
	Lead Temperature	300 (0.063 in (1.6mm) from case for 10 sec)	°C
	Weight	4.3 (typical)	g

# IRFY340CM Device

## Electrical Characteristics @ T<sub>J</sub> = 25°C (Unless Otherwise Specified)

	Parameter	Min.	Typ.	Max.	Units	Test Conditions
BV <sub>DSS</sub>	Drain-to-Source Breakdown Voltage	400	—	—	V	V <sub>GS</sub> = 0V, I <sub>D</sub> = 1.0mA
ΔBV <sub>DSS</sub> /ΔT <sub>J</sub>	Temperature Coefficient of Breakdown Voltage	—	0.46	—	V/°C	Reference to 25°C, I <sub>D</sub> = 1.0mA
R <sub>DS(on)</sub>	Static Drain-to-Source On-State Resistance	—	—	0.55	Ω	V <sub>GS</sub> = 10V, I <sub>D</sub> = 5.5A <sup>④</sup>
		—	—	0.63		V <sub>GS</sub> = 10V, I <sub>D</sub> = 8.7A
V <sub>GS(th)</sub>	Gate Threshold Voltage	2.0	—	4.0	V	V <sub>DS</sub> = V <sub>GS</sub> , I <sub>D</sub> = 250μA
g <sub>fs</sub>	Forward Transconductance	4.9	—	—	S (S)	V <sub>DS</sub> ≥ 15V, I <sub>DS</sub> = 5.5A <sup>④</sup>
I <sub>DSS</sub>	Zero Gate Voltage Drain Current	—	—	25	μA	V <sub>DS</sub> = 0.8 x max. rating, V <sub>GS</sub> = 0V
		—	—	250		V <sub>DS</sub> = 0.8 x max. rating V <sub>GS</sub> = 0V, T <sub>J</sub> = 25°C
I <sub>GSS</sub>	Gate-to-Source Leakage Forward	—	—	100	nA	V <sub>GS</sub> = 20V
I <sub>GSS</sub>	Gate-to-Source Leakage Reverse	—	—	-100		V <sub>GS</sub> = -20V
Q <sub>g</sub>	Total Gate Charge	32	—	65	nC	V <sub>GS</sub> = 10V, I <sub>D</sub> = 8.7A
Q <sub>gs</sub>	Gate-to-Source Charge	2.2	—	10		V <sub>DS</sub> = Max. Rating x 0.5
Q <sub>gd</sub>	Gate-to-Drain ('Miller') Charge	13.8	—	40.5		see figures 6 and 13
t <sub>d(on)</sub>	Turn-On Delay Time	—	—	25	ns	V <sub>DD</sub> = 200V, I <sub>D</sub> = 8.7A, R <sub>G</sub> = 9.1Ω V <sub>GS</sub> = 10V  see figure 10
t <sub>r</sub>	Rise Time	—	—	92		
t <sub>d(off)</sub>	Turn-Off Delay Time	—	—	79		
t <sub>f</sub>	Fall Time	—	—	58		
L <sub>D</sub>	Internal Drain Inductance	—	8.7	—	nH	Measured from the drain lead, 6mm (0.25 in.) from package to center of die.
L <sub>S</sub>	Internal Source Inductance	—	8.7	—		Measured from the source lead, 6mm (0.25 in.) from package to source bonding pad.
C <sub>iss</sub>	Input Capacitance	—	1400	—	pF	V <sub>GS</sub> = 0V, V <sub>DS</sub> = 25V f = 1.0MHz. see figure 5
C <sub>oss</sub>	Output Capacitance	—	350	—		
C <sub>rss</sub>	Reverse Transfer Capacitance	—	230	—		



## Source-Drain Diode Ratings and Characteristics

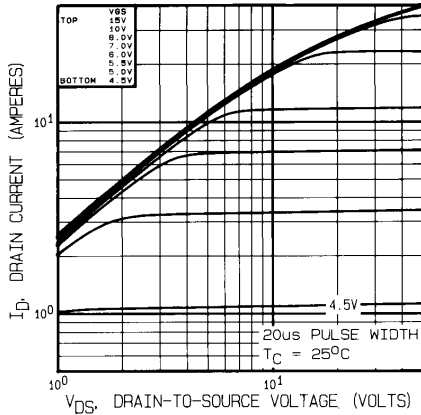
	Parameter	Min.	Typ.	Max.	Units	Test Conditions
I <sub>S</sub>	Continuous Source Current (Body Diode)	—	—	8.7	A	Modified MOSFET symbol showing the integral reverse p-n junction rectifier.
I <sub>SM</sub>	Pulse Source Current (Body Diode) <sup>①</sup>	—	—	35		
V <sub>SD</sub>	Diode Forward Voltage	—	—	1.5	V	T <sub>J</sub> = 25°C, I <sub>S</sub> = 8.7A, V <sub>GS</sub> = 0V <sup>④</sup>
t <sub>rr</sub>	Reverse Recovery Time	—	—	600	ns	T <sub>J</sub> = 25°C, I <sub>F</sub> = 8.7A, di/dt ≤ 100 A/μs
Q <sub>RR</sub>	Reverse Recovery Charge	—	—	5.6	μC	V <sub>DD</sub> ≤ 50 V <sup>④</sup>
t <sub>on</sub>	Forward Turn-On Time	Intrinsic turn-on time is negligible. Turn-on speed is substantially controlled by L <sub>S</sub> + L <sub>D</sub> .				



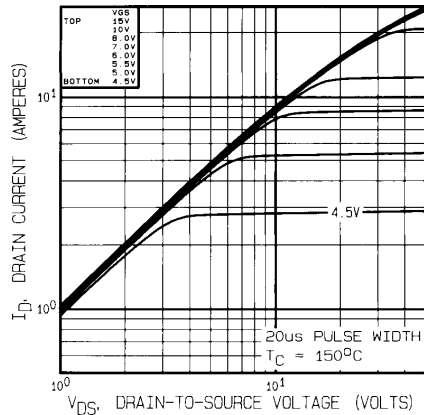
## Thermal Resistance

	Parameter	Min.	Typ.	Max.	Units	Test Conditions
R <sub>thJC</sub>	Junction-to-Case	—	—	1.25	KW <sup>⑤</sup>	Typical socket mount Mounting surface flat, smooth
R <sub>thJA</sub>	Junction-to-Ambient	—	—	80		
R <sub>thCS</sub>	Case-to-Sink	—	0.21	—		

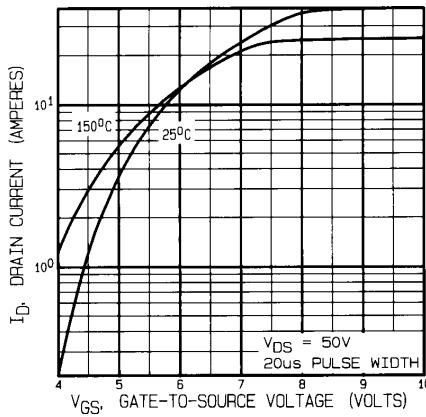
# IRFY340CM Device



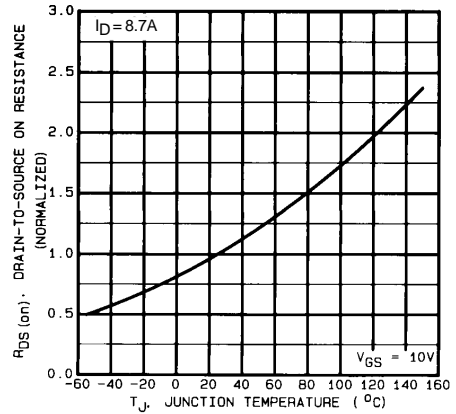
**Fig. 1 — Typical Output Characteristics**  
 $T_C = 25^\circ\text{C}$



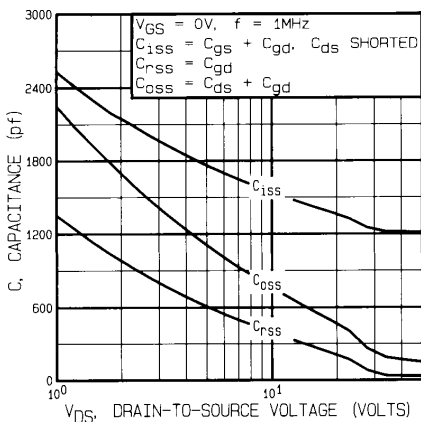
**Fig. 2 — Typical Output Characteristics**  
 $T_C = 150^\circ\text{C}$



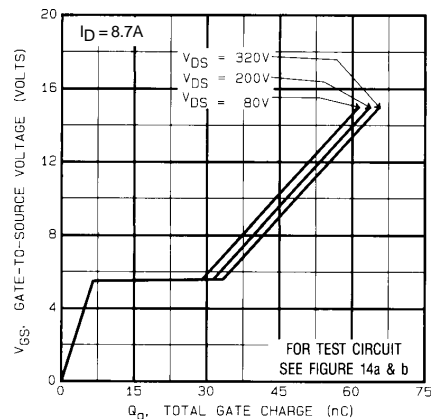
**Fig. 3 — Typical Transfer Characteristics**



**Fig. 4 — Normalized On-Resistance Vs. Temperature**

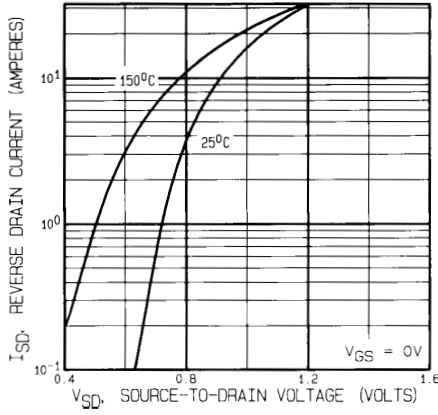


**Fig. 5 — Typical Capacitance Vs. Drain-to-Source Voltage**

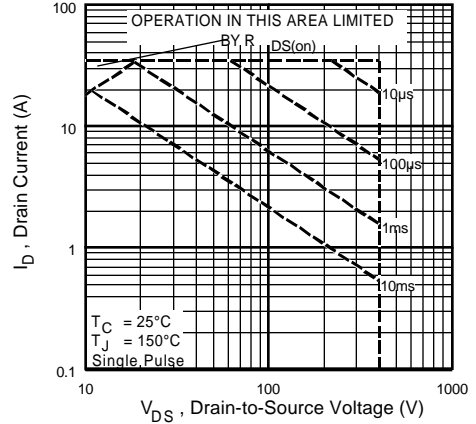


**Fig. 6 — Typical Gate Charge Vs. Gate-to-Source Voltage**

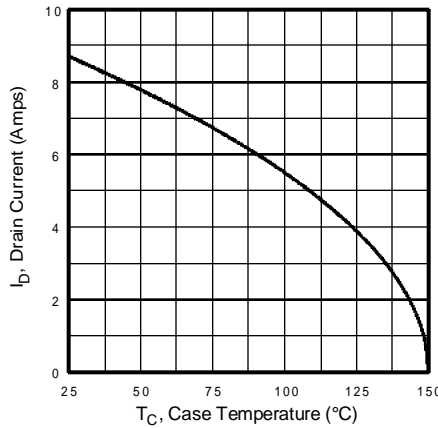
# IRFY340CM Device



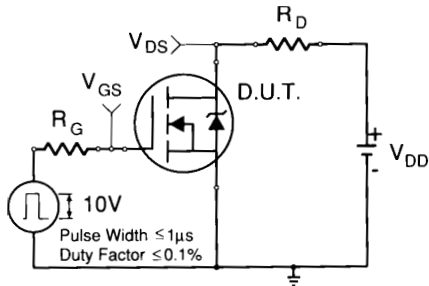
**Fig. 7 — Typical Source-to-Drain Diode Forward Voltage**



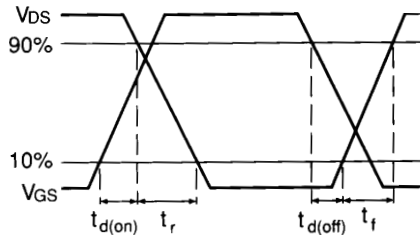
**Fig. 8 — Maximum Safe Operating Area**



**Fig. 9 — Maximum Drain Current Vs. Case Temperature**



**Fig. 10a — Switching Time Test Circuit**



**Fig. 10b — Switching Time Waveforms**

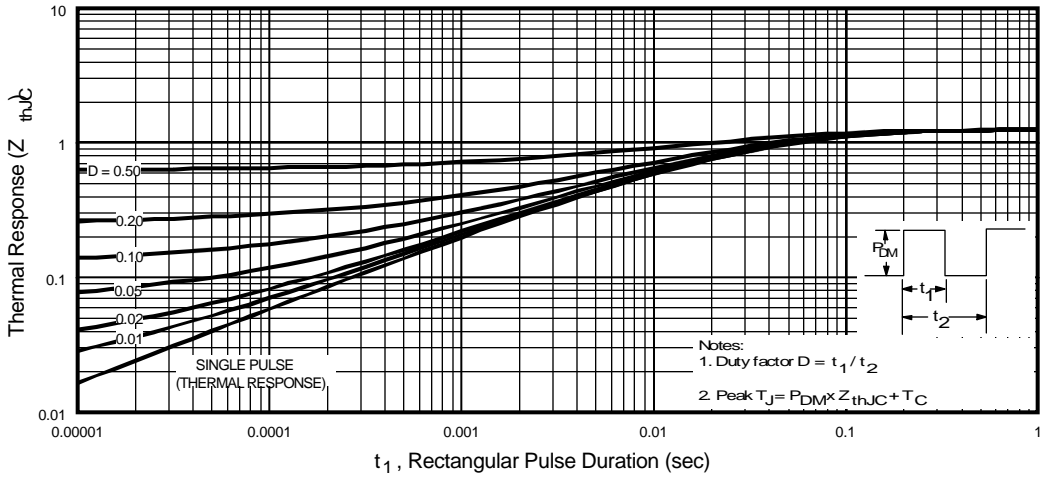


Fig. 11 — Maximum Effective Transient Thermal Impedance, Junction-to-Case Vs. Pulse Duration

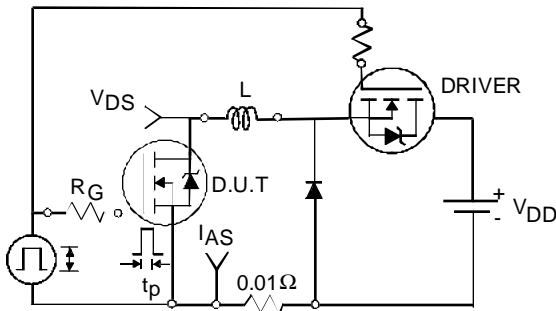


Fig. 12a — Unclamped Inductive Test Circuit

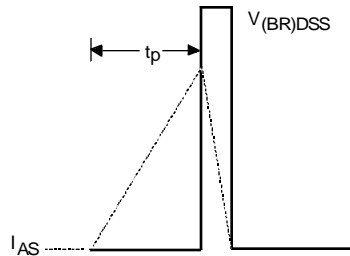


Fig. 12b — Unclamped Inductive Waveforms

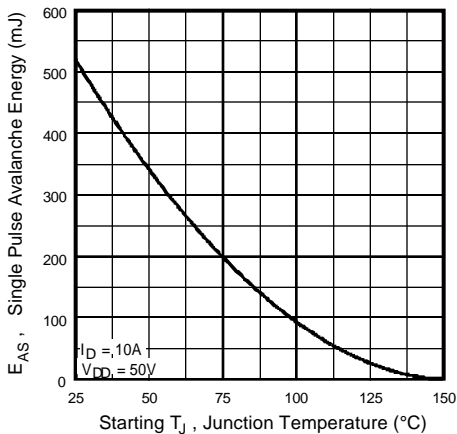


Fig. 12c — Max. Avalanche Energy vs. Current

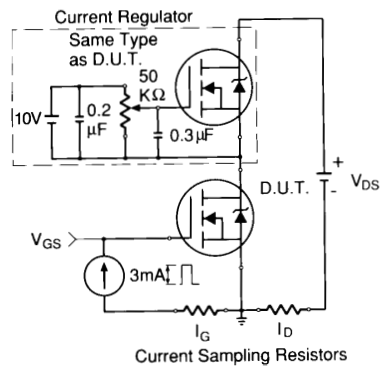


Fig. 13a — Gate Charge Test Circuit

# IRFY340CM Device

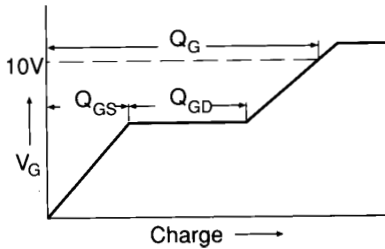


Fig. 13b — Basic Gate Charge Waveform

### Notes:

- ① Repetitive Rating; Pulse width limited by maximum junction temperature (see figure 11).
- ② @  $V_{DD} = 50V$ , Starting  $T_J = 25^\circ C$ ,  
 $E_{AS} = [0.5 * L * (I_L^2) * [BV_{DSS}/(BV_{DSS}-V_{DD})]]$   
 Peak  $I_L = 8.7A$ ,  $V_{GS} = 10V$ ,  $25 \leq R_G \leq 200\Omega$  (figure 12)
- ③  $I_{SD} \leq 8.7A$ ,  $di/dt \leq 120A/\mu s$ ,  $V_{DD} \leq BV_{DSS}$ ,  $T_J \leq 150^\circ C$
- ④ Pulse width  $\leq 300 \mu s$ ; Duty Cycle  $\leq 2\%$
- ⑤  $K/W = ^\circ C/W$        $W/K = W/^\circ C$

## Case Outline and Dimensions — TO-257AA

Pin 1 - Drain  
Pin 2 - Source  
Pin 3 - Gate

**TO-257AA**

**NON-STANDARD PIN CONFIGURATION**

*Pin 1 - Gate*  
*Pin 2 - Drain*  
*Pin 3 - Source*

**Order Part Type IRFY340C**

**NOTES:**

1. Dimensioning and tolerancing per ANSI Y14.5M-1982
2. Controlling dimension: Inch
3. Dimensions are shown in millimeters (Inches)
4. Outline conforms to JEDEC outline TO-257AA

**CAUTION**

**BERYLLIA WARNING PER MIL-PRF-19500**

Packages containing beryllia shall not be ground, sandblasted, machined or have other operations performed on them which will produce beryllia or beryllium dust. Furthermore, beryllium oxide packages shall not be placed in acids that will produce fumes containing beryllium.

# International **IR** Rectifier

**WORLD HEADQUARTERS:** 233 Kansas St., El Segundo, California 90245, Tel: (310) 322 3331  
**EUROPEAN HEADQUARTERS:** Hurst Green, Oxted, Surrey RH8 9BB, UK Tel: ++ 44(0) 1883 732020  
**IR CANADA:** 7321 Victoria Park Ave., Suite 201, Markham, Ontario L3R 2Z8, Tel: (905) 475 1897  
**IR GERMANY:** Saalburgstrasse 157, 61350 Bad Homburg Tel: ++ 49 6172 96590  
**IR ITALY:** Via Liguria 49, 10071 Borgaro, Torino Tel: ++ 39 11 451 0111  
**IR FAR EAST:** K&H Bldg., 2F, 3-30-4 Nishi-Ikeburo 3-Chome, Toshima-Ki, Tokyo Japan 171 Tel: 81 3 3983 0086  
**IR SOUTHEAST ASIA:** 315 Outram Road, #10-02 Tan Boon Liat Building, Singapore 0316 Tel: 65 221 8371  
<http://www.irf.com/>      Data and specifications subject to change without notice.      6/96