

INTERNATIONAL RECTIFIER 

REPETITIVE AVALANCHE RATED AND dv/dt RATED

HEXFET® TRANSISTOR

IRFV360

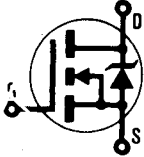

N-CHANNEL

400 Volt, 0.20 Ohm HEXFET

The HEXFET® technology is the key to International Rectifier's advanced line of power MOSFET transistors. The efficient geometry design achieves very low on-state resistance combined with high transconductance.

The HEXFET transistors also feature all of the well established advantages of MOSFETs such as voltage control, very fast switching, ease of paralleling and temperature stability of the electrical parameters.

They are well suited for applications such as switching power supplies and virtually any application where military and/or high reliability is required.

Product Summary

Part Number	V_{DSS}	$R_{DS(on)}$	I_D
IRFV360	400V	0.20Ω	25A

FEATURES:

- Repetitive Avalanche Rating
- Dynamic dv/dt Rating
- Isolated and Hermetically Sealed
- Alternative to TO-3 Package
- Simple Drive Requirements
- Ease of Paralleling
- Ceramic Eyelets

CASE STYLE AND DIMENSIONS

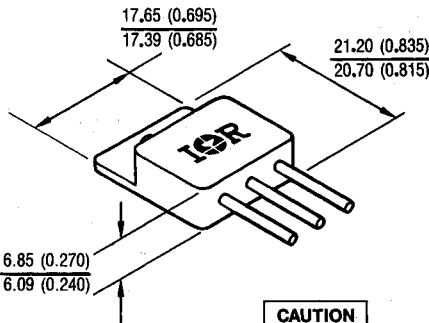

**BERYLLIA WARNING PER MIL-S-19500
SEE PAGE I-482.**

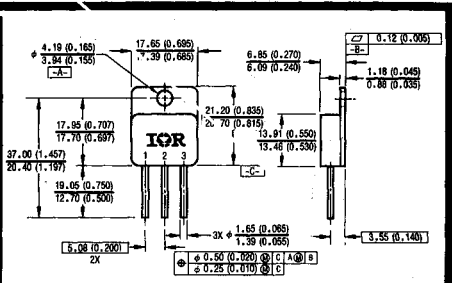

NOTES:
 1 DIMENSIONING & TOLERANCING PER ANSI Y14.5M - 1982.
 2 ALL DIMENSIONS ARE SHOWN IN MILLIMETERS (INCHES).
 3 GATE

LEGEND
 1 DRAIN
 2 SOURCE
 3 GATE

*For optional leadforms see page I-462, fig. 15

Conforms to JEDEC Outline TO-258AA*
 Dimensions in Millimeters and (Inches)

Absolute Maximum Ratings

Parameter	IRFV360	Units
I_D @ $V_{GS} = 10V, T_C = 25^\circ C$	25	A
I_D @ $V_{GS} = 10V, T_C = 100^\circ C$	16	
I_{DM}	100	
P_D @ $T_C = 25^\circ C$	300	W
	2.4	W/K $\text{\textcircled{D}}$
V_{GS}	± 20	V
E_{AS}	980	mJ
I_{AR}	25	A
E_{AR}	30	mJ
dv/dt	4.0	V/ns
T_J	-55 to 150	°C
T_{STG}		
Lead Temperature	300 (0.063 in. (1.6 mm) from case for 10s)	
Weight	10.9 (typical)	g

Electrical Characteristics @ $T_J = 25^\circ C$ (Unless Otherwise Specified)

Parameter	Min.	Typ.	Max.	Units	Test Conditions
BV_{DSS}	400	—	—	V	$V_{GS} = 0V, I_D = 1.0 mA$
$\Delta BV_{DSS}/\Delta T_J$	—	0.46	—	V/°C	Reference to 25°C, $I_D = 1.0 mA$
$R_{DS(on)}$	—	—	0.20	Ω	$V_{GS} = 10V, I_D = 16A$ $\text{\textcircled{D}}$
	—	—	0.23		$V_{GS} = 10V, I_D = 25A$
$V_{GS(th)}$	2.0	—	4.0	V	$V_{DS} = V_{GS}, I_D = 250 \mu A$
g_{fs}	14	—	—	S (f)	$V_{DS} \geq 15V, I_{DS} = 16A$ $\text{\textcircled{D}}$
I_{DSS}	—	—	25	μA	$V_{DS} = 0.8 \times \text{Max. Rating}, V_{GS} = 0V$
	—	—	250		$V_{DS} = 0.8 \times \text{Max. Rating}$ $V_{GS} = 0V, T_J = 125^\circ C$
I_{GSS}	—	—	100	nA	$V_{GS} = 20V$
I_{GSS}	—	—	-100		$V_{GS} = -20V$
Q_g	—	—	210		$V_{GS} = 10V, I_D = 25A$
Q_{gs}	—	—	28	nC	$V_{DS} = 0.5 \times \text{Max. Rating}$
Q_{gd}	—	—	120		See Fig. 6 and 14
$t_{d(on)}$	—	—	33	ns	$V_{DD} = 200V, I_D = 25A, R_G = 2.35\Omega$ See Fig. 11
t_r	—	—	140		
$t_{d(off)}$	—	—	120		
t_f	—	—	99		
L_D	—	8.7	—	nH	Measured from the drain lead, 6 mm (0.25 in.) from package to center of die. Measured from the source lead, 6 mm (0.25 in.) from package to source bonding pad.
L_S	—	8.7	—		
C_{iss}	—	4200	—	pF	$V_{GS} = 0V, V_{DS} = 25V$ $f = 1.0 MHz$ See Fig. 5 $f = 1.0 MHz$
C_{oss}	—	900	—		
C_{rss}	—	400	—		
C_{DC}	—	12	—		



Source-Drain Diode Ratings and Characteristics

Parameter	Min.	Typ.	Max.	Units	Test Conditions
I_S Continuous Source Current (Body Diode)	—	—	25	A	Modified MOSFET symbol showing the integral Reverse p-n junction rectifier. 
I_{SM} Pulsed Source Current (Body Diode) ①	—	—	100		
V_{SD} Diode Forward Voltage	—	—	1.8	V	$T_J = 25^\circ\text{C}$, $I_S = 25\text{A}$, $V_{GS} = 0\text{V}$ ④
t_{rr} Reverse Recovery Time	—	—	1000	nS	$T_J = 25^\circ\text{C}$, $I_F = 25\text{A}$, $dI/dt \leq 100\text{ A}/\mu\text{s}$ ④
Q_{RR} Reverse Recovery Charge	—	—	16	μC	$V_{DD} \leq 50\text{V}$
t_{on} Forward Turn-On Time	Intrinsic turn-on time is negligible. Turn-on speed is substantially controlled by $L_S + L_D$.				

Thermal Resistance

Parameter	Min.	Typ.	Max.	Units	Test Conditions
R_{thJC} Junction-to-Case	—	—	0.42	K/W ⑤	
R_{thCS} Case-to-Sink	—	0.21	—		Mounting surface flat, smooth, and greased
R_{thJA} Junction-to-Ambient	—	—	30		Typical socket mount

① Repetitive Rating; Pulse width limited by maximum junction temperature (see figure 9) Refer to current HEXFET reliability report

② @ $V_{DD} = 50\text{V}$, Starting $T_J = 25^\circ\text{C}$, $L \geq 2.7\text{ mH}$, $R_G = 25\Omega$, Peak $I_L = 25\text{A}$

③ $I_{SD} \leq 25\text{A}$, $dI/dt \leq 170\text{ A}/\mu\text{s}$, $V_{DD} \leq BV_{DSS}$, $T_J \leq 150^\circ\text{C}$, Suggested $R_G = 2.35\Omega$

④ Pulse width $\leq 300\ \mu\text{s}$; Duty Cycle $\leq 2\%$

⑤ $K/W = ^\circ\text{C}/W$
 $W/K = W/^\circ\text{C}$

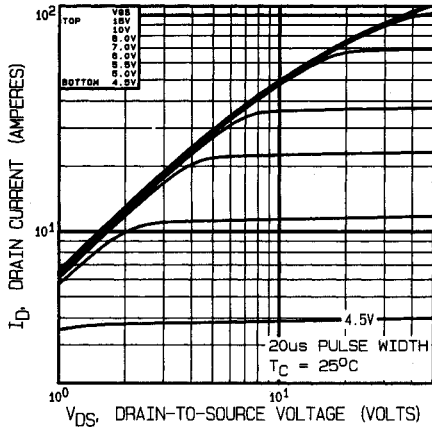

Fig. 1 — Typical Output Characteristics, $T_C = 25^\circ\text{C}$

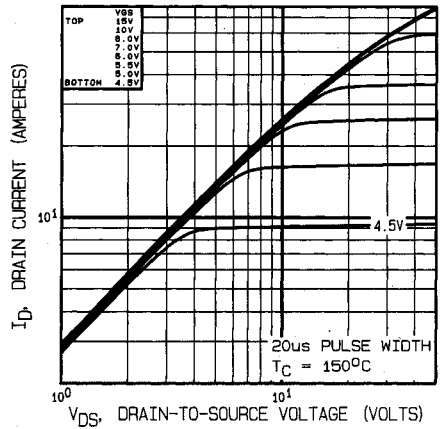

Fig. 2 — Typical Output Characteristics, $T_C = 150^\circ\text{C}$

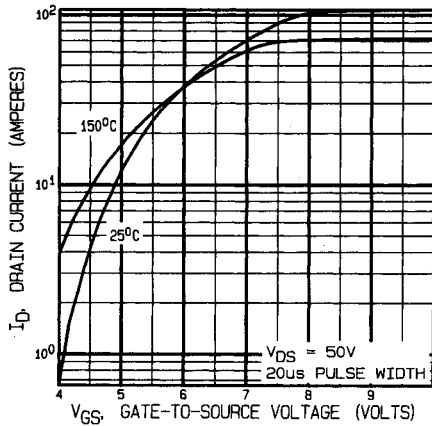

Fig. 3 — Typical Transfer Characteristics

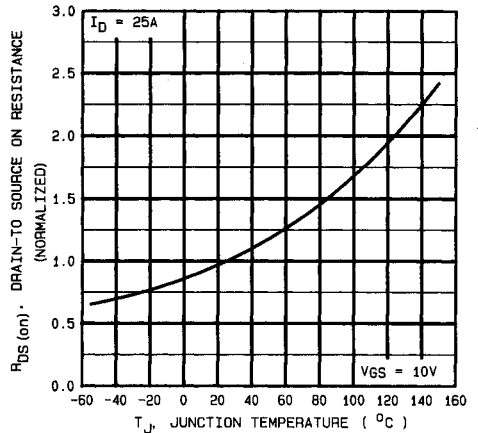

Fig. 4 — Normalized On-Resistance Vs. Temperature

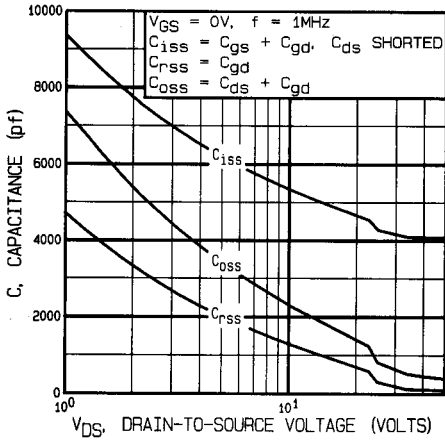

Fig. 5 — Typical Capacitance Vs. Drain-to-Source Voltage

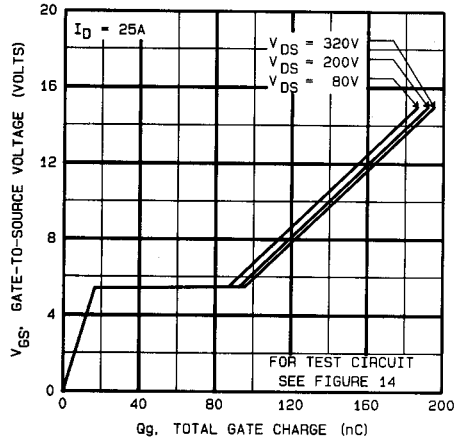

Fig. 6 — Typical Gate Charge Vs. Gate-to-Source Voltage

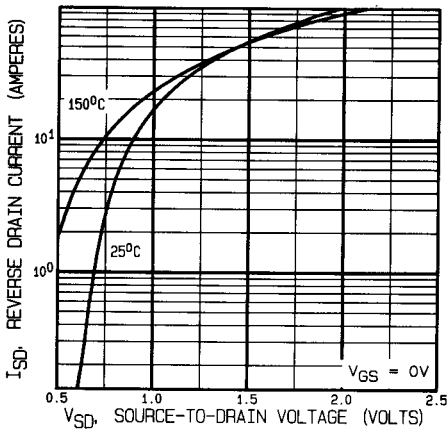

Fig. 7 — Typical Source-Drain Diode Forward Voltage

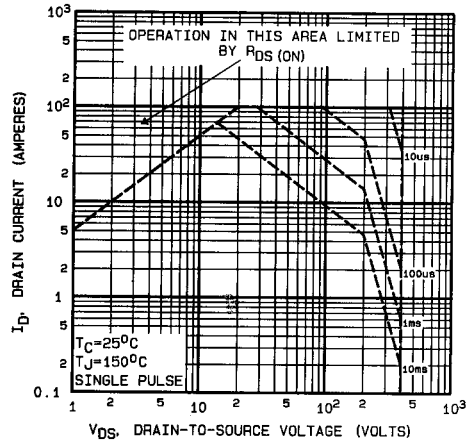

Fig. 8 — Maximum Safe Operating Area

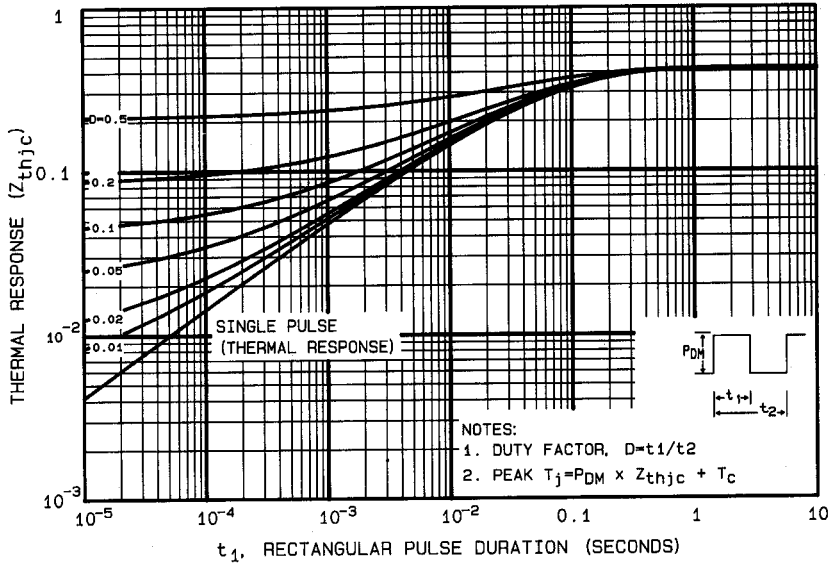

Fig. 9 — Maximum Effective Transient Thermal Impedance, Junction-to-Case Vs. Pulse Duration

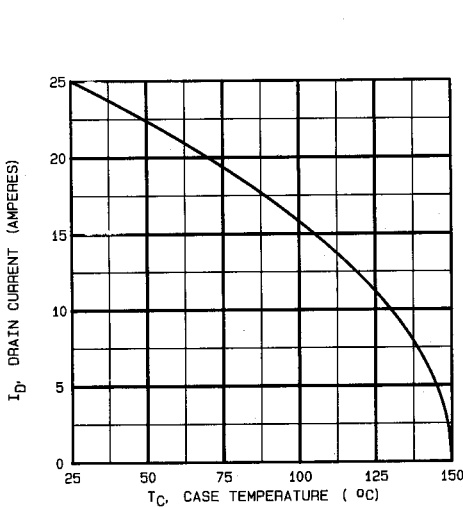

Fig. 10 — Maximum Drain Current Vs. Case Temperature

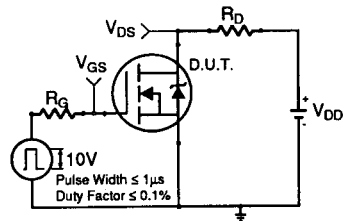

Fig. 11a — Switching Time Test Circuit

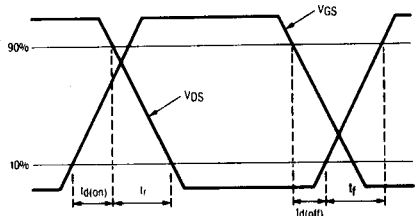
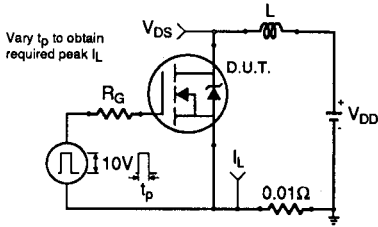
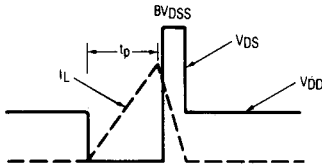
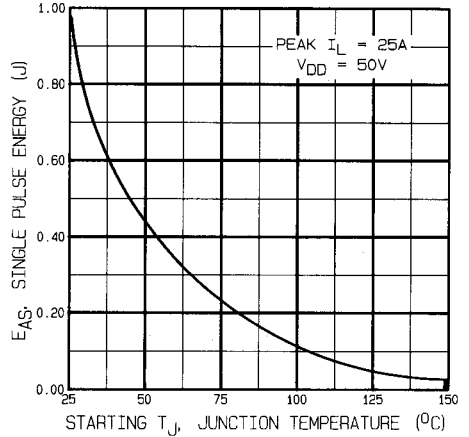
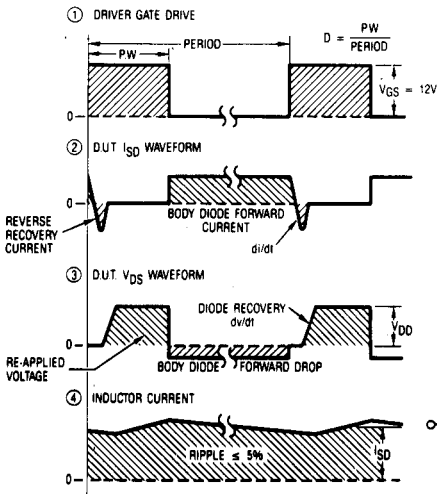

Fig. 11b — Switching Time Waveforms

Fig. 12a — Unclamped Inductive Test Circuit

Fig. 12b — Unclamped Inductive Waveforms

Fig. 12c — Maximum Avalanche Energy Vs. Starting Junction Temperature

Fig. 13 — Peak Diode Recovery dv/dt Test Circuit
