

Quad 2-Input AND Gate

IN74VHC08

IN74VHC08 is high-speed logic IC made by CMOS technology and designed for use in high-performance calculating systems with a wide supply voltage range.

As for operation speed, IN74VHC08 can be compared with equivalent bipolar ICs based on Schottky TTL and two times surpasses ICs of IN74HC series.

IN74VHC08 tolerates operation under conditions when voltage on input is exceeded up to 7V without affecting characteristics and IC reliability. This possibility allows to use IN74VHC08 in radio-electronic devices for interfacing with supply voltages 5V and 3V, eliminate IC failure under supply voltage source emergency outage.

Use of output edge shaping block in the microcircuit allows to reduce noise amplitude of noises when switching outputs into the same state simultaneously.

Input and output levels of IN74VHC08 are compatible with CMOS levels

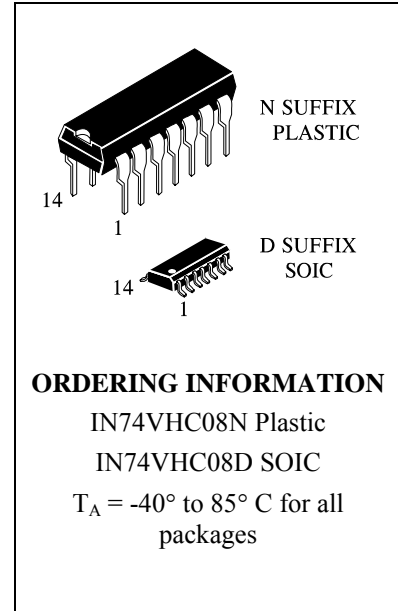

Features:

- Supply voltage range 2.0 to 5.5 V.
- Output current 8 mA.
- Low consumption current: 0.2 mA (typical value) at $T_a = 25^\circ\text{C}$.
- Latchup current not less than 300 mA at $T_a = 85^\circ\text{C}$.
- Tolerable value of static potential not less than 2000 V as per human body model (HBM) and not less than 200 V as per machine model (MM).
- Ambient operation temperature minus 40 to plus 85 $^\circ\text{C}$.
- Balanced signal propagation delay.
- Ensures voltage exceeding mode on input
- Low noise level at the simultaneous switching of outputs in the same state: $V_{OLP} = 0.8$ V (max).
- For pins and functions, compatible with IN74HC08.

IN74VHC08 truth table

Input		Output
A	B	$Y = A * B$
L	L	L
L	H	L
H	L	L
H	H	H

Note –
 H - high voltage level;
 L - low voltage level;

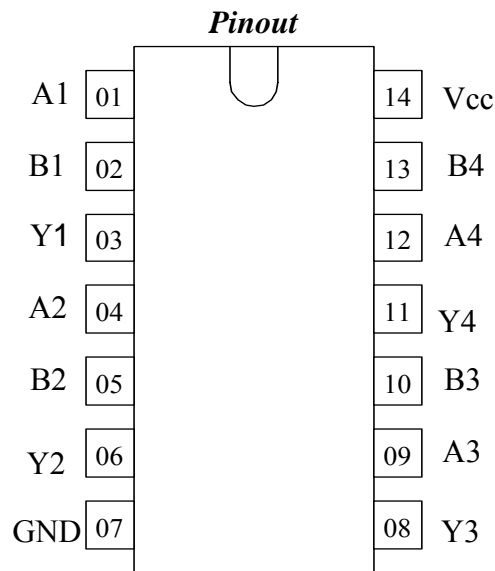

Pins description in IN74VHC08

Pin No.	Symbol	Description
01	A1	Input
02	B1	Input
03	Y1	Output
04	A2	Input
05	B2	Input
06	Y2	Output
07	GND	Common output
08	Y3	Output
09	A3	Input
10	B3	Input
11	Y4	Output
12	A4	Input
13	B4	Input
14	V _{CC}	Supply output from voltage source

Absolute maximum conditions*

Parameter, unit	Symbol	Value	
		min	max
Supply voltage, V	V_{CC}	-0.5	7.0
Input voltage, V	V_{in}	-0.5	7.0
Output voltage, V	V_{out}	-0.5	$V_{CC}+0.5V$
Input diode current, mA	I_{ik}	–	-20
Current of common output and supply output, mA	I_{cc}	–	± 50
Output current, mA	I_{out}	–	± 25
Output diode current, mA	I_{ok}	–	± 20
Dissipated power, mW	P_d	–	180

*Under absolute maximum conditions operation of microcircuit is not guaranteed. Operation is guaranteed under maximum conditions

Maximum conditions

Parameter, unit	Symbol	Value	
		min	max
Supply voltage, V	V_{CC}	2.0	5.5
Input voltage, V	V_{in}	0	V_{CC}
Output voltage, V	V_{out}	0	V_{CC}
Output current, mA	I_{out}	–	± 8.0
Input rise and fall time, ns/V	t_{LH}, t_{HL}	0	100
at $V_{CC} = (3.3 \pm 0.3) V$		0	20
at $V_{CC} = (5.0 \pm 0.5) V$			

DC electrical characteristics

Symbol	Parameter	Test conditions	V _{CC} , V	Value				Unit
				25 °C		-40 to 85 °C		
				min	max	min	max	
V _{IH}	High level input voltage	V _O ≤ 0.1 V or V _O ≥ V _{CC} - 0.1 V	2.0	1.5	-	1.5	-	V
			3.0	0.7 V _{CC}		0.7 V _{CC}		
			4.5	0.7 V _{CC}		0.7 V _{CC}		
			5.5	0.7 V _{CC}		0.7 V _{CC}		
V _{IL}	Low level input voltage	V _O ≤ 0.1 V or V _O ≥ V _{CC} - 0.1 V	2.0	-	0.5		0.5	
			3.0		0.3 V _{CC}		0.3 V _{CC}	
			4.5		0.3 V _{CC}		0.3 V _{CC}	
			5.5		0.3 V _{CC}		0.3 V _{CC}	
V _{OH}	High level output voltage	V _I = V _{IH} or V _{IL} I _{OH} = -50 uA	2.0	1.92	-	1.9	-	
			3.0	2.92		2.9		
			4.5	4.42		4.4		
			5.5	5.42		5.4		
			3.0	2.58		2.48		
			4.5	3.94		3.8		
V _{OL}	Low level output voltage	V _I = V _{IH} or V _{IL} I _{OL} = 50 uA	2.0	-	0.09	-	0.1	
			3.0		0.09		0.1	
			4.5		0.09		0.1	
			5.5		0.09		0.1	
			3.0		0.36		0.44	
			4.5		0.36		0.44	
I _{IL}	Low level input current	V _I = 0 B	5.5		-0.1		-1.0	uA
I _{IH}	High level input current	V _I = V _{CC}	5.5		0.1		1.0	
I _{IH1}	High level input current	V _I = 5.5 B	0		0.1		1.0	
I _{CC}	Consumption current	V _I = 0 B или V _{CC}	5.5		2.0		20	

AC electrical characteristics ($t_{LH} = t_{HL} = 3.0$ ns $V_{IL} = 0$ V, $V_{IH} = V_{CC}$.)

Symbol	Parameter	Test conditions	V_{CC} , V	C_L , pF	Value				Unit
					25 °C		-40 to 85 °C		
					min	max	min	max	
t_{PHL}, t_{PLH}	Propagation delay time when switching "on", "off"		3.3 ± 0.3	15	-	8.8	-	10.5	ns
				50		12.3		14.0	
			5.0 ± 0.5	15		5.9		7.0-	
				50		7.9		9.0	
C_I	Input capacity	-	5.0			10		pF	
C_{PD}	Dynamic capacity	$V_I = 0$ V or V_{CC}	5.0			36			

Noise characteristics ($C_L = 50$ pF)

Symbol	Parameter	V_{CC} , V	Value		Unit
			min	max	
V_{OLP}	Positive noise of low output voltage	5.0	-	0.8	V
V_{OLV}	Negative noise of low output voltage	5.0	-0.8	-	
V_{IHD}	Input dynamic high voltage	5.0	3.5	-	
V_{ILD}	Input dynamic low voltage	5.0	-	1.5	

- Time diagram of input and output pulses

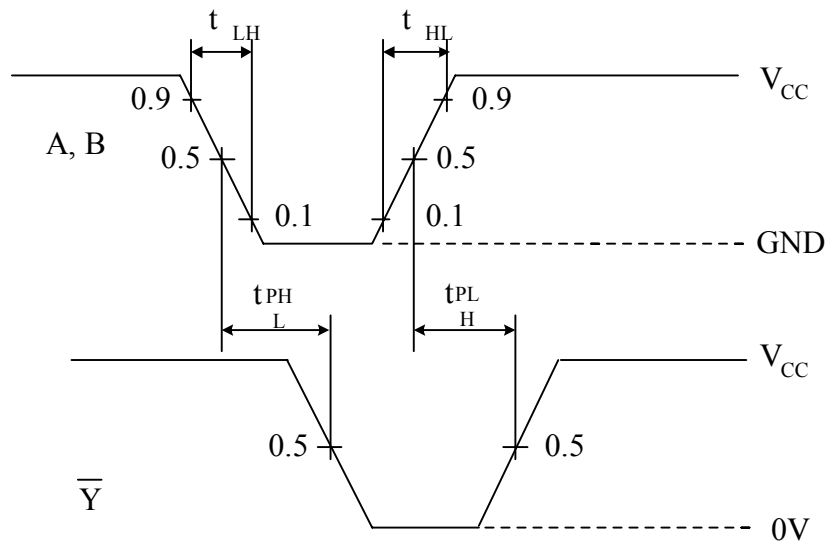

**N SUFFIX PLASTIC DIP
(MS - 001AA)**

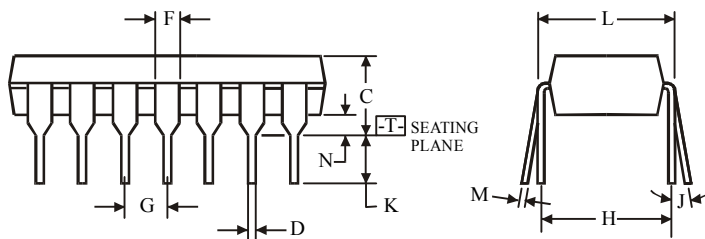
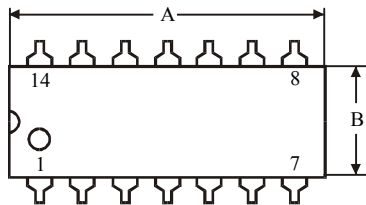
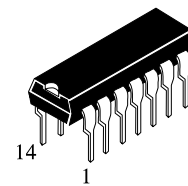

$\oplus 0.25 (0.010) \text{ (M) } T$

NOTES:

1. Dimensions "A", "B" do not include mold flash or protrusions.
Maximum mold flash or protrusions 0.25 mm (0.010) per side.

Symbol	Dimension, mm	
	MIN	MAX
A	18.67	19.69
B	6.1	7.11
C		5.33
D	0.36	0.56
F	1.14	1.78
G	2.54	
H	7.62	
J	0°	10°
K	2.92	3.81
L	7.62	8.26
M	0.2	0.36
N	0.38	

**D SUFFIX SOIC
(MS - 012AB)**

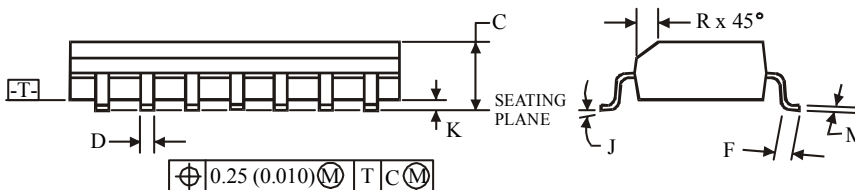
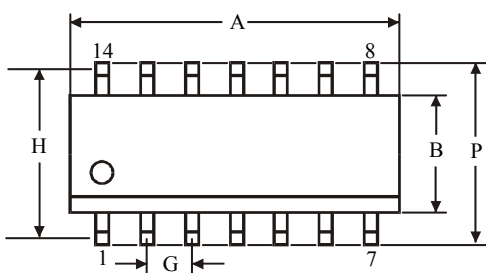
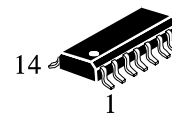

$\oplus 0.25 (0.010) \text{ (M) } T \text{ (C) (M)}$

NOTES:

1. Dimensions A and B do not include mold flash or protrusion.
2. Maximum mold flash or protrusion 0.15 mm (0.006) per side for A; for B - 0.25 mm (0.010) per side.

Symbol	Dimension, mm	
	MIN	MAX
A	8.55	8.75
B	3.8	4
C	1.35	1.75
D	0.33	0.51
F	0.4	1.27
G	1.27	
H	5.27	
J	0°	8°
K	0.1	0.25
M	0.19	0.25
P	5.8	6.2
R	0.25	0.5