

IN74HC393

DUAL 4-STAGE BINARY RIPPLE COUNTER High-Performance Silicon-Gate CMOS

The IN74HC393 is identical in pinout to the LS/ALS393. The device inputs are compatible with standard CMOS outputs; with pullup resistors, they are compatible with LS/ALSTTL outputs.

This device consists of two independent 4-bit binary ripple counters with parallel outputs from each counter stage. A 2^8 counter can be obtained by cascading the two binary counters.

Internal flip-flops are triggered by high-to-low transitions of the clock input. Reset for the counters is asynchronous and active-high. State changes of the Q outputs do not occur simultaneously because of internal ripple delays. Therefore, decoded output signals are subject to decoding spikes and should not be used as clocks or as strobes except when gated with the Clock of the IN74HC393.

- Outputs Directly Interface to CMOS, NMOS, and TTL
- Operating Voltage Range: 2.0 to 6.0 V
- Low Input Current: 1.0 μ A
- High Noise Immunity Characteristic of CMOS Devices

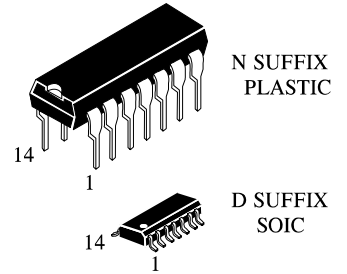

ORDERING INFORMATION

IN74HC393N Plastic
IN74HC393D SOIC
 $T_A = -55^\circ$ to 125° C for all packages

LOGIC DIAGRAM

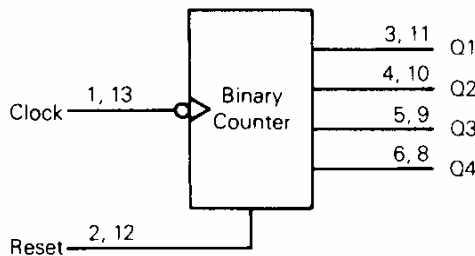

PIN 14 = V_{CC}
PIN 7 = GND

PIN ASSIGNMENT

| | | | |
|-----------------|---|----|-----------------|
| Clock a | 1 | 14 | V_{CC} |
| Reset a | 2 | 13 | Clock b |
| Q1 _a | 3 | 12 | Reset b |
| Q2 _a | 4 | 11 | Q1 _b |
| Q3 _a | 5 | 10 | Q2 _b |
| Q4 _a | 6 | 9 | Q3 _b |
| GND | 7 | 8 | Q4 _b |

FUNCTION TABLE

| Inputs | | Outputs |
|--------|-------|-----------------------|
| Clock | Reset | |
| X | H | L |
| H | L | No Change |
| L | L | No Change |
| | L | No Change |
| | L | Advance to Next State |

X = don't care

IN74HC393

MAXIMUM RATINGS*

| Symbol | Parameter | Value | Unit |
|-----------|---|------------------------|--------------------|
| V_{CC} | DC Supply Voltage (Referenced to GND) | -0.5 to +7.0 | V |
| V_{IN} | DC Input Voltage (Referenced to GND) | -1.5 to $V_{CC} + 1.5$ | V |
| V_{OUT} | DC Output Voltage (Referenced to GND) | -0.5 to $V_{CC} + 0.5$ | V |
| I_{IN} | DC Input Current, per Pin | ± 20 | mA |
| I_{OUT} | DC Output Current, per Pin | ± 25 | mA |
| I_{CC} | DC Supply Current, V_{CC} and GND Pins | ± 50 | mA |
| P_D | Power Dissipation in Still Air, Plastic DIP+ SOIC Package+ | 750 500 | mW |
| Tstg | Storage Temperature | -65 to +150 | $^{\circ}\text{C}$ |
| T_L | Lead Temperature, 1 mm from Case for 10 Seconds (Plastic DIP or SOIC Package) | 260 | $^{\circ}\text{C}$ |

*Maximum Ratings are those values beyond which damage to the device may occur. Functional operation should be restricted to the Recommended Operating Conditions.

+Derating - Plastic DIP: - 10 mW/ $^{\circ}\text{C}$ from 65 $^{\circ}$ to 125 $^{\circ}\text{C}$

SOIC Package: : - 7 mW/ $^{\circ}\text{C}$ from 65 $^{\circ}$ to 125 $^{\circ}\text{C}$

RECOMMENDED OPERATING CONDITIONS

| Symbol | Parameter | Min | Max | Unit |
|-------------------|--|-----|----------|--------------------|
| V_{CC} | DC Supply Voltage (Referenced to GND) | 2.0 | 6.0 | V |
| V_{IN}, V_{OUT} | DC Input Voltage, Output Voltage (Referenced to GND) | 0 | V_{CC} | V |
| T_A | Operating Temperature, All Package Types | -55 | +125 | $^{\circ}\text{C}$ |
| t_r, t_f | Input Rise and Fall Time (Figure 1) | | | ns |
| | $V_{CC} = 2.0 \text{ V}$ | 0 | 1000 | |
| | $V_{CC} = 4.5 \text{ V}$ | 0 | 500 | |
| | $V_{CC} = 6.0 \text{ V}$ | 0 | 400 | |

This device contains protection circuitry to guard against damage due to high static voltages or electric fields. However, precautions must be taken to avoid applications of any voltage higher than maximum rated voltages to this high-impedance circuit. For proper operation, V_{IN} and V_{OUT} should be constrained to the range $\text{GND} \leq (V_{IN} \text{ or } V_{OUT}) \leq V_{CC}$.

Unused inputs must always be tied to an appropriate logic voltage level (e.g., either GND or V_{CC}). Unused outputs must be left open.

IN74HC393

DC ELECTRICAL CHARACTERISTICS (Voltages Referenced to GND)

| Symbol | Parameter | Test Conditions | V _{CC} V | Guaranteed Limit | | | Unit |
|-----------------|--|---|----------------------|----------------------|-----------|------------|------|
| | | | | 25 °C to -55°C | ≤85 °C | ≤125 °C | |
| V _{IH} | Minimum High-Level Input Voltage | V _{OUT} =0.1 V or V _{CC} -0.1 V I _{OUT} ≤ 20 μA | 2.0 | 1.5 | 1.5 | 1.5 | V |
| | | | 4.5 | 3.15 | 3.15 | 3.15 | |
| | | | 6.0 | 4.2 | 4.2 | 4.2 | |
| V _{IL} | Maximum Low-Level Input Voltage | V _{OUT} =0.1 V or V _{CC} -0.1 V I _{OUT} ≤ 20 μA | 2.0 | 0.3 | 0.3 | 0.3 | V |
| | | | 4.5 | 0.9 | 0.9 | 0.9 | |
| | | | 6.0 | 1.2 | 1.2 | 1.2 | |
| V _{OH} | Minimum High-Level Output Voltage | V _{IN} =V _{IH} or V _{IL} I _{OUT} ≤ 20 μA | 2.0 | 1.9 | 1.9 | 1.9 | V |
| | | | 4.5 | 4.4 | 4.4 | 4.4 | |
| | | 6.0 | 5.9 | 5.9 | 5.9 | | |
| | | V _{IN} =V _{IH} or V _{IL} I _{OUT} ≤ 4.0 mA I _{OUT} ≤ 5.2 mA | 4.5 | 3.98 | 3.84 | 3.7 | |
| 6.0 | 5.48 | 5.34 | 5.2 | | | | |
| V _{OL} | Maximum Low-Level Output Voltage | V _{IN} =V _{IH} or V _{IL} I _{OUT} ≤ 20 μA | 2.0 | 0.1 | 0.1 | 0.1 | V |
| | | | 4.5 | 0.1 | 0.1 | 0.1 | |
| | | 6.0 | 0.1 | 0.1 | 0.1 | | |
| | | V _{IN} =V _{IH} or V _{IL} I _{OUT} ≤ 4.0 mA I _{OUT} ≤ 5.2 mA | 4.5 | 0.26 | 0.33 | 0.4 | |
| 6.0 | 0.26 | 0.33 | 0.4 | | | | |
| I _{IN} | Maximum Input Leakage Current | V _{IN} =V _{CC} or GND | 6.0 | ±0.1 | ±1.0 | ±1.0 | μA |
| I _{CC} | Maximum Quiescent Supply Current (per Package) | V _{IN} =V _{CC} or GND I _{OUT} =0μA | 6.0 | 8.0 | 80 | 160 | μA |

IN74HC393

AC ELECTRICAL CHARACTERISTICS ($C_L=50\text{pF}$, Input $t_r=t_f=6.0\text{ ns}$)

| Symbol | Parameter | V_{CC} V | Guaranteed Limit | | | Unit |
|--------------------------|--|---------------|----------------------|-------|------------|------|
| | | | 25 °C to -55°C | ≤85°C | ≤125 °C | |
| f_{max} | Maximum Clock Frequency (50% Duty Cycle) (Figures 1 and 3) | 2.0 | 5.4 | 4.4 | 3.6 | MHz |
| | | 4.5 | 27 | 22 | 18 | |
| | | 6.0 | 32 | 26 | 21 | |
| t_{PLH} , t_{PHL} | Maximum Propagation Delay, Clock to Q1 (Figures 1 and 3) | 2.0 | 120 | 150 | 180 | ns |
| | | 4.5 | 24 | 30 | 36 | |
| | | 6.0 | 20 | 26 | 31 | |
| t_{PLH} , t_{PHL} | Maximum Propagation Delay, Clock to Q2 (Figures 1 and 3) | 2.0 | 190 | 240 | 285 | ns |
| | | 4.5 | 38 | 48 | 57 | |
| | | 6.0 | 32 | 41 | 48 | |
| t_{PLH} , t_{PHL} | Maximum Propagation Delay, Clock to Q3 (Figures 1 and 3) | 2.0 | 240 | 300 | 360 | ns |
| | | 4.5 | 48 | 60 | 72 | |
| | | 6.0 | 41 | 51 | 61 | |
| t_{PLH} , t_{PHL} | Maximum Propagation Delay, Clock to Q4 (Figures 1 and 3) | 2.0 | 290 | 365 | 435 | ns |
| | | 4.5 | 58 | 73 | 87 | |
| | | 6.0 | 49 | 62 | 74 | |
| t_{PHL} | Maximum Propagation Delay, Reset to any Q (Figures 2 and 3) | 2.0 | 165 | 205 | 250 | ns |
| | | 4.5 | 33 | 41 | 50 | |
| | | 6.0 | 28 | 35 | 43 | |
| t_{TLH} , t_{THL} | Maximum Output Transition Time, Any Output (Figures 1 and 3) | 2.0 | 75 | 95 | 110 | ns |
| | | 4.5 | 15 | 19 | 22 | |
| | | 6.0 | 13 | 16 | 19 | |
| C_{IN} | Maximum Input Capacitance | - | 10 | 10 | 10 | pF |

| | | | | | |
|----------|--|--------------------------------------|--|--|----|
| C_{PD} | Power Dissipation Capacitance (Per Counter) | Typical @25°C, $V_{CC}=5.0\text{ V}$ | | | pF |
| | Used to determine the no-load dynamic power consumption: $P_D=C_{PD}V_{CC}^2f+I_{CC}V_{CC}$ | 40 | | | |

TIMING REQUIREMENTS ($C_L=50\text{pF}$, Input $t_r=t_f=6.0\text{ ns}$)

| Symbol | Parameter | V_{CC} V | Guaranteed Limit | | | Unit |
|---------------|---|---------------|-------------------|-------|--------|------|
| | | | 25 °C to- 55°C | ≤85°C | ≤125°C | |
| t_{rec} | Minimum Recovery Time, Reset Inactive to Clock (Figure 2) | 2.0 | 50 | 65 | 75 | ns |
| | | 4.5 | 10 | 13 | 15 | |
| | | 6.0 | 9 | 11 | 13 | |
| t_w | Minimum Pulse Width, Clock (Figure 1) | 2.0 | 80 | 100 | 120 | ns |
| | | 4.5 | 16 | 20 | 24 | |
| | | 6.0 | 14 | 17 | 20 | |
| t_w | Minimum Pulse Width, Set (Figure 2) | 2.0 | 125 | 155 | 190 | ns |
| | | 4.5 | 25 | 31 | 38 | |
| | | 6.0 | 21 | 26 | 32 | |
| t_r , t_f | Maximum Input Rise and Fall Times (Figure 1) | 2.0 | 1000 | 1000 | 1000 | ns |
| | | 4.5 | 500 | 500 | 500 | |
| | | 6.0 | 400 | 400 | 400 | |

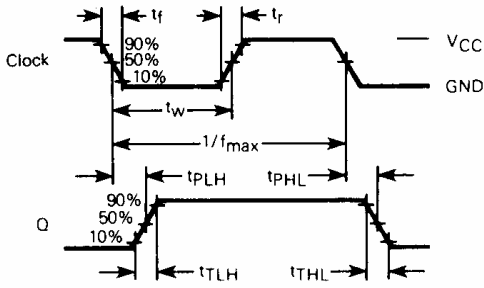

Figure 1. Switching Waveform

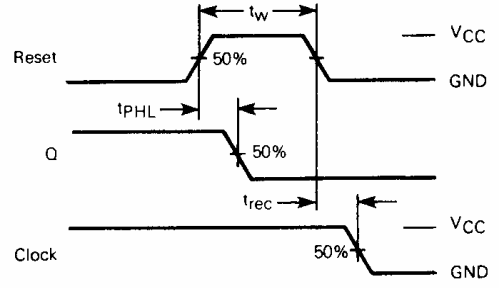
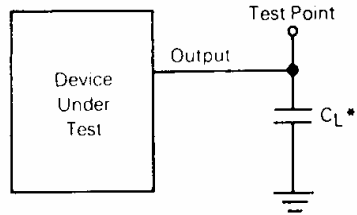

Figure 2. Switching Waveform



* Includes all probe and jig capacitance

Figure 4. Test Circuit

EXPANDED LOGIC DIAGRAM

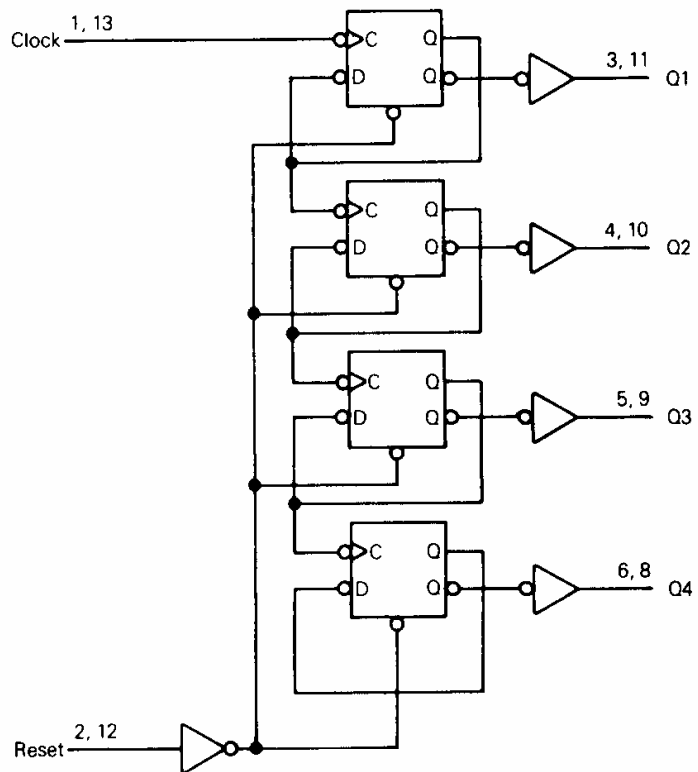

IN74HC393

TIMING DIAGRAM

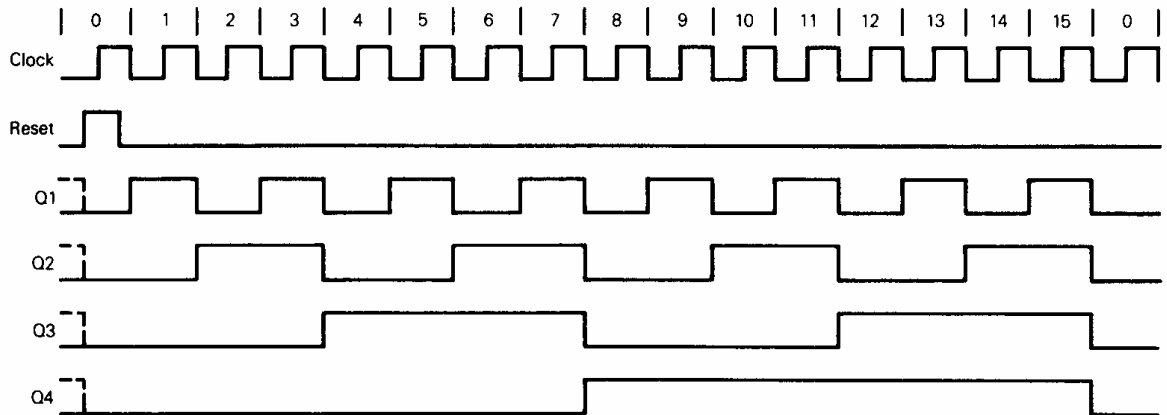

COUNT SEQUENCE

| Count | Outputs | | | |
|-------|---------|----|----|----|
| | Q4 | Q3 | Q2 | Q1 |
| 0 | L | L | L | L |
| 1 | L | L | L | H |
| 2 | L | L | H | L |
| 3 | L | L | H | H |
| 4 | L | H | L | L |
| 5 | L | H | L | H |
| 6 | L | H | H | L |
| 7 | L | H | H | H |
| 8 | H | L | L | L |
| 9 | H | L | L | H |
| 10 | H | L | H | L |
| 11 | H | L | H | H |
| 12 | H | H | L | L |
| 13 | H | H | L | H |
| 14 | H | H | H | L |
| 15 | H | H | H | H |