

Input to output electric strength test 1500 VDC

Input voltage ranges 32...75VDC for -0302

Dual output

- Industry standard pin-out
- Fixed frequency operation
- High efficiency up to 89 %
- 2" x 2" platform with 9.4 mm profile
- Low output noise
- Soft start
- Shut down input, output voltages adjustable
- Programmable input undervoltage lockout
- Synchronisation
- Outputs no-load, overload and short-circuit proof
- Operating ambient temperature -40...71°C
- Thermal protection with auto-reset (non latching)
- Emissions below EN 55022, level B
- Immunity to IEC/EN 61000-4-2,-3,-4,-5 and -6

Safety according to IEC/EN 60950, UL 1950



Approvals pending

IMS30 Series

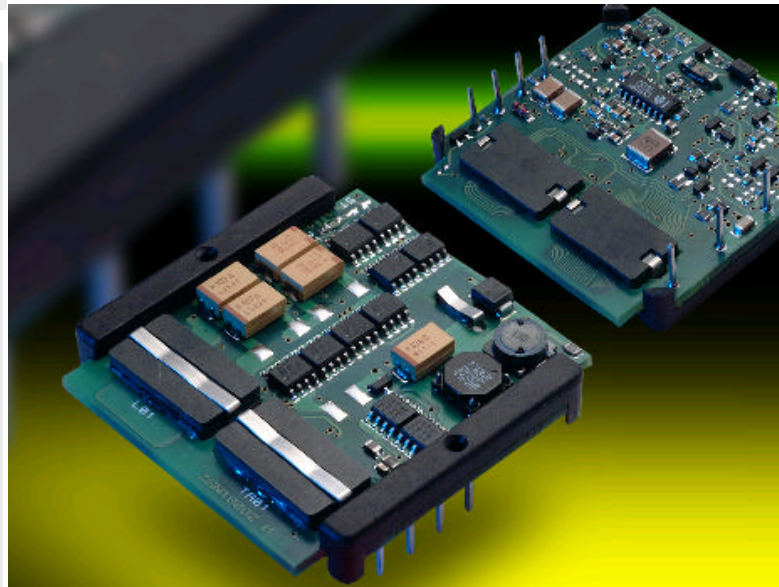

Summary

The IMS 30 series of board mountable 30 Watt DC-DC converters has been designed according to the latest industry requirements and standards. The converters are particularly suitable for applications in industry and telecommunication where variable input voltages or high transient voltages are prevalent.

Features include efficient input and output filtering with unsurpassed transient and surge protection, low output ripple and noise, consistently high efficiency over the entire input voltage range, high reliability as well as excellent dynamic response to load and line changes.

The converters provide supplementary insulation with SELV outputs as e.g. required in battery supported systems where the bus voltage may exceed the SELV limit of 60 V DC. They are designed and built according to the international safety standards IEC/EN 60950, UL 1950, CAN/CSA C22.2 No.950-95. Approvals pending.

The circuit comprises integrated planar magnetics and all components are automatically assembled and soldered onto a single PCB without any wire connections. The proprietary magnetic feedback solution ensures maximum reliability and repeatability in the control loop over all operating conditions. Careful considerations of possible thermal stresses ensure the absence of hot spots providing long life in environments where temperature cycles are a reality. The thermal design allows operation at full load up to an ambient temperature of 71 °C in free air without using any potting material.

Table of Contents

	Page		Page
Summary	1	Auxiliary Functions	6
Type Survey and Key Data	2	Electromagnetic Compatibility (EMC)	7
Type Key	2	Immunity to Environmental Conditions	8
Functional Description	2	Mechanical Data	9
Electrical Input Data	3	Safety and Installation Instructions	10
Electrical Output Data	4	Description of Option	11

Type Survey and Key Data

Table 1: Type survey

Output 1		Output 2		Output power	Input Voltage Range and Efficiency		Option
$U_{o1\ nom}$ [V DC]	$I_{o1\ nom}$ [A]	$U_{o2\ nom}$ [V DC]	$I_{o1\ nom}$ [A]	$P_{o\ nom}$ [W]	$U_{i\ min} \dots U_{i\ max}$ 32...75 V DC	η_{typ} [%]	
5.1	4.5	3.3	6.0	30	48 IMS 30-0503-9G	87	i
3.3	4.0	1.8	5.0	22	48 IMS 30-0302-9G	83	i

Type Key

Input voltage range U_i

32...75 V DC 48

Series IMS 30

Output voltage type output (5.1 and 3.3Vout)

Operating ambient temperature range T_A

-40...71 °C -9

Synchronous rectifier G

Option: Inhibit i

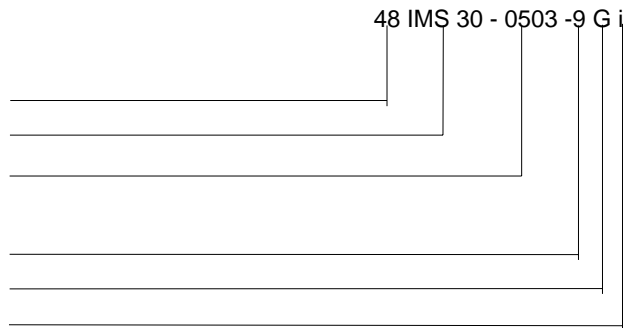

Functional Description

The IMS 30 series of DC-DC converters are magnetic feedback controlled forward converters using current mode PWM (Pulse Width Modulation).

This product range features synchronous rectifiers delivering in very high efficiency. The output voltage of these versions can be adjusted via the Trim input. The Trim input is referenced to the secondary side and allows for programming of the output voltage in the range of approximately 90 to 110% of $U_{o\ nom}$ using an external resistor.

The voltage regulation is achieved with a magnetic feedback circuit providing excellent line and load regulation.

Current limitation is provided by the primary circuit, thus limiting the total output power to approx. 130% of $P_{o\ nom}$ (see: *Type Survey*). The shut down input allows remote converter on/off.

Overtemperature protection will shut down the unit in excessive overload conditions with automatic restart.

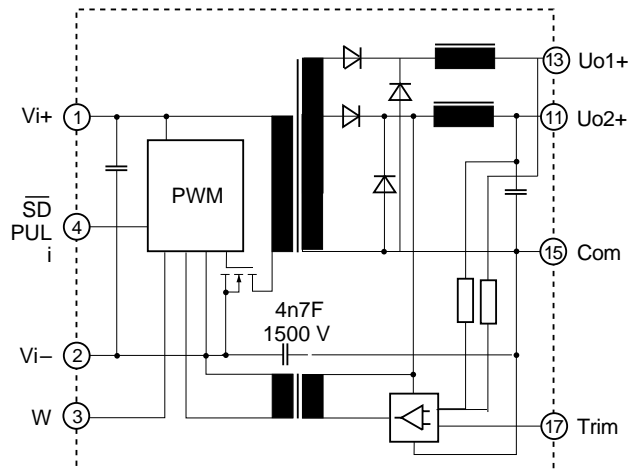

Fig. 1
Block diagram (-0503, -0302 Outputs)

Electrical Input Data

General conditions:

- $T_A = 25\text{ C}$, unless T_C is specified.
- Shut down pin left open circuit (not connected).
- Trim input not connected.

Table 2: Input Data

Input		Conditions	48 IMS			Unit	
Characteristics			min	typ	max		
U_i	Input voltage range ¹	$T_C \text{ min...} T_C \text{ max}$ $I_o = 0 \dots I_o \text{ nom}$	32		75	V DC	
$U_{i \text{ nom}}$	Nominal input voltage		48				
$U_{i \text{ sur}}$	Repetitive input surge voltage		100				
$t_{\text{start up}}$	Converter start-up time	Switch on $\overline{\text{SD}}$ high	$U_{i \text{ min}}, I_o = I_o \text{ nom}$ ²		0.25	0.5	s
					0.1		
t_{rise}	Rise time		5		ms		
$I_{i \text{ NL}}$	No load input current	$I_o = 0, U_{i \text{ min}} \dots U_{i \text{ max}}$ SD high	30	40	mA		
C_i	Input capacitance	for surge calculation	1.5		uF		
$U_{\overline{\text{SD}}}$	Shut down voltage	Unit disabled	-10	0.7		V DC	
		Unit operating	1.5	5			
$I_{\overline{\text{SD}}}$	Input current of $\overline{\text{SD}}$ input		1	2	mA		
$I_{\text{inr p}}$	Inrush peak current ⁴	$U_i = U_{i \text{ nom}}$	1.5		A		
f_s	Switching frequency	$U_{i \text{ min}}, I_o \text{ nom}$	approx. 250		kHz		
$I_{i \text{ rr}}$	Reflected ripple current	$I_o = 0 \dots I_o \text{ nom}$	60		mA _{pp}		
$U_{i \text{ RFI}}$	Input RFI level conducted	EN 55022 ³	B				

¹ $U_{i \text{ min}}$ will not be as stated if U_o is increased above $U_{o \text{ nom}}$ by use of the Trim input. If the output voltage is set to a higher value, $U_{i \text{ min}}$ will be proportionally increased.

² Measured with a resistive and the max. admissible capacitive load.

³ Measured with a lead length of 0.1 m, leads twisted.

⁴ Source impedance according to prETS 300132-2, version 4.3.

Inrush Current

The inrush current has been kept as low as possible by choosing a very small input capacitance.

A series resistor may be installed in the input line to further limit this current.

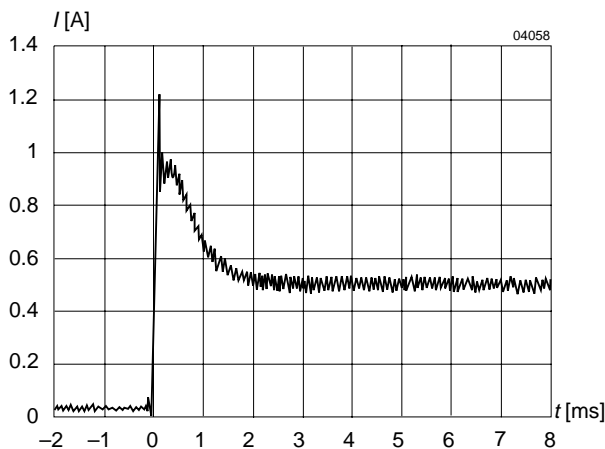

Fig. 2

Typical inrush current at $U_{i \text{ nom}}, P_{o \text{ nom}}$ versus time (48 IMS30-0503-9G). Source impedance according to prETS 300132-2, version 4.3 at $U_{i \text{ nom}}$.

Input Undervoltage Lock-out

The IMS30 converters are fitted with a defined input undervoltage lock-out:

48 IMS 30 turn off 31.5 V
 turn on 32 V
(approx. values)

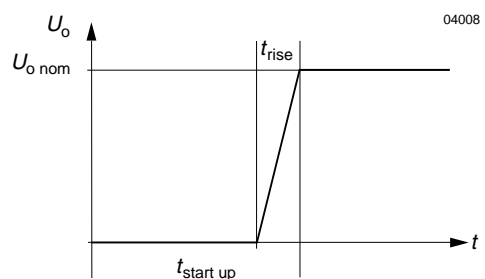

Fig. 3

Converter start-up and rise time (applying $U_{i \text{ nom}}$).

Input Transient Voltage Protection

A built-in suppressor diode provides effective protection against input transients which may be caused for example by short-circuits across the input lines where the network inductance may cause high energy pulses.

Table 3: Built-in transient voltage suppressor

Type	Breakdown voltage $V_{BR, nom}$ [V]	Peak power at 1 ms P_P [W]	Peak pulse current I_{PP} [A]
48 IMS 30	100	600	4.1

For very high energy transients as for example to achieve IEC/EN 61000-4-5 or ETR 283 (19 Pf1) compliance (as per table: *Electromagnetic Immunity*) an external inductor and capacitor are required.

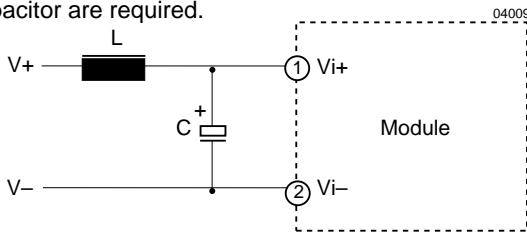

Electrical Output Data

Table 5a: Output data.

Model		48IMS30-0503-9G	5.1 V			3.3 V		Unit	
Characteristics		Conditions	min	typ	max	min	typ		max
U_{o1}	Output voltage	$U_{i, nom}, I_o = 0.5 I_{o, nom}$	5.00		5.20	3.25		3.35	V
$I_{o, nom}$	Output current	$U_{i, min} \dots U_{i, max}$	0		3.5	0		6	A
I_{oL}	Current limit ¹	$U_{i, nom}$			6			9	
U_o	Line regulation	$U_{i, min} \dots U_{i, max}$	+/-0.5			+/-0.5		%	
	Load regulation	$I_o = (0 \dots 1) I_{o, nom}$	See Fig. 6			+/-1			
u_{o1}	Output voltage noise ²		75			50		mV _{pp}	
$C_{o, ext}$	Admissible capacitive load		2000			2000		uF	
$u_{o, d}$	Dynamic load regulation	Voltage deviation	250			250		mV	
t_d		Recovery time	1			1		ms	
U_o	Temperature coefficient U_o / T_C	$U_{i, nom}, I_{o, nom}$ $T_C, min \dots T_C, max$	0.02			0.02		%/K	

Table 5b: Output data.

Model		48IMS30-0302-9G	3.3 V			1.8 V		Unit	
Characteristics		Conditions	min	typ	max	min	typ		max
U_{o1}	Output voltage	$U_{i, nom}, I_o = 0.5 I_{o, nom}$	3.25		3.35	1.77		1.83	V
$I_{o, nom}$	Output current	$U_{i, min} \dots U_{i, max}$	0		4	0		5	A
I_{oL}	Current limit ¹	$U_{i, nom}$			6			7	
U_o	Line regulation	$U_{i, min} \dots U_{i, max}$	+/-0.5			+/-0.5		%	
	Load regulation	$I_o = (0 \dots 1) I_{o, nom}$	See Fig. 6			+/-3			
u_{o1}	Output voltage noise ²		50			50		mV _{pp}	
$C_{o, ext}$	Admissible capacitive load		2000			2000		uF	
$u_{o, d}$	Dynamic load regulation	Voltage deviation	250			150		mV	
t_d		Recovery time	1			1		ms	
U_o	Temperature coefficient U_o / T_C	$U_{i, nom}, I_{o, nom}$ $T_C, min \dots T_C, max$	0.02			0.02		%/K	

¹ The current limit is primary side controlled.

² BW = 20 MHz

Table 4: Components for external circuitry to comply with IEC/EN 61000-4-5, level 2 or ETR 283 (19 Pf1) (48 IMS types).

Circuit Ref.	48 IMS 30
L	150 uH
C	100 uF, 100 V, 85 C

Reverse Polarity Protection at the Input

The built-in suppressor diode also provides for reverse polarity protection at the input by conducting current in the reverse direction. An external fuse is required to limit this current:

48 IMS 30: 3.15 A (F3.15A)

Fig. 4

Example for external circuitry to comply with IEC/EN 61000-4-5 or ETR 283 (19 Pf1) (48 IMS 30 types).

Fig 6: Cross regulation and load regulation for double output units.

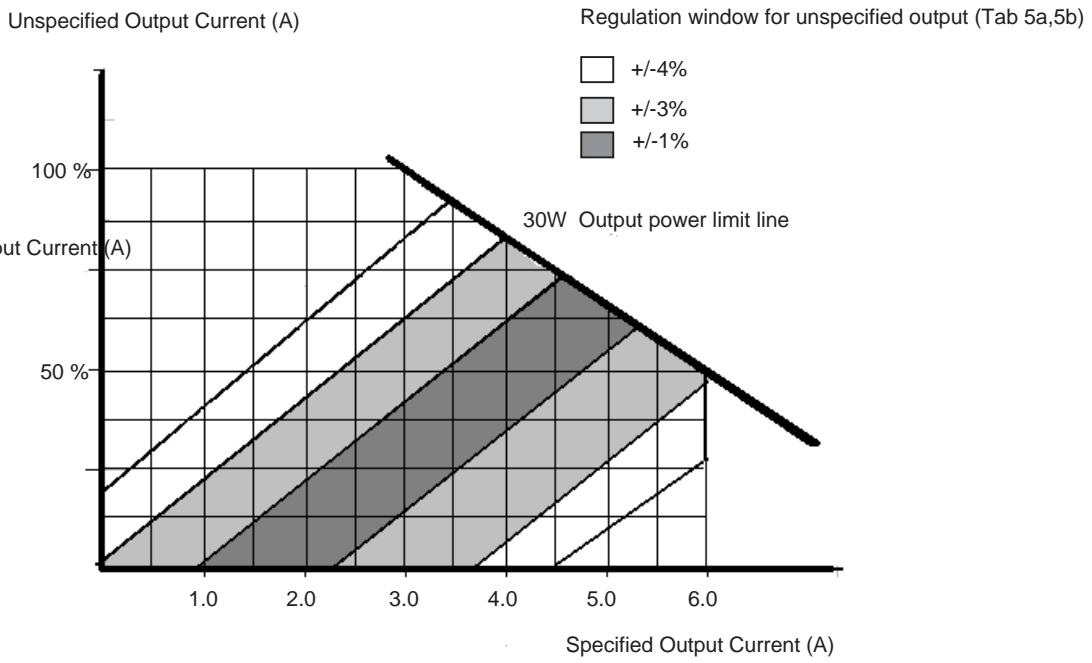

Auxiliary Functions

Shut Down Function

The outputs of the converters may be enabled or disabled by means of a logic signal (TTL, CMOS, etc.) applied to the shut down pin. If the shut down function is not required then pin should be left open-circuit.

Converter operating: 2.0...5.0 V
 Converter shut down: -1...0.7 V

The shut down pin can also be used as a programmable undervoltage lockout. The undervoltage lockout values for the 48 IMS30 series is 31 V with a 0.5V hysteresis window which can be trimmed up by means of an external resistor connected between the SD/PUL pin and Vi- pin.

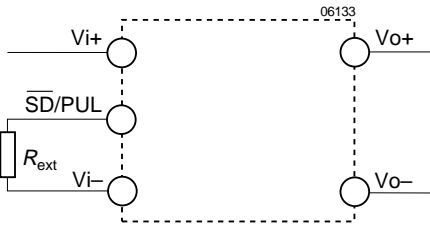

Fig. 8 Shut down (\overline{SD}) and undervoltage lockout (PUL) function.

Table 6: Typical values for undervoltage lockout (PUL) settings.

48 IMS 30	
R_{ext} [k]	$U_{i min}$ [V]
	31
50	34
29	36
20	38
15	40

Synchronisation

The IMS 30 provides a bi-directional synchronisation function to synchronise several IMS 30 units operated in parallel connection. When the W pins (SYNC) are connected together, the converters will lock to the highest switching frequency. The faster controller becomes the master, producing a 4.3 V, 200 ns pulse train. Only one, the highest frequency SYNC signal, will appear on the Sync line.

Adjustable Output Voltage

As a standard feature, the IMS 30 units offer adjustable output voltage by using the secondary referenced control Trim. If the control input is left open-circuit the output voltage is set to $U_{o nom}$. Adjustment of the output voltage is possible by means of an external resistor R_{ext} connected between the Trim pin and the either Vo+ or Vo-.

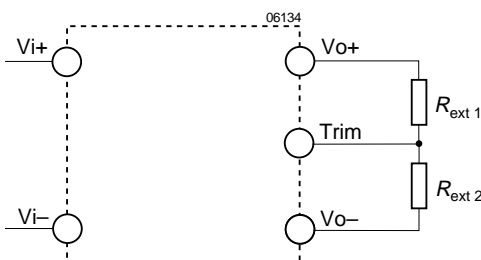

Fig. 9 Output voltage Trim.

Table 7: U_o versus U_{ext} for $U_o = 90...110\% U_{o nom}$; typical values ($U_{i nom}$, $I_{o1/2} = 0.5 I_{o1/2 nom}$)

$U_{o nom}$ [V]	$R_{ext 1}$		$R_{ext 2}$	
	U_o [V]	[k]	U_o [V]	[k]
3.3	2.97	8	3.63	5

Thermal Considerations

If a converter, mounted on a PCB, is located in free, quasi-stationary air (convection cooling) at the indicated maximum ambient temperature $T_{A max}$ (see table: *Temperature specifications*) and is operated at its nominal input voltage and output power, the case temperature T_C measured at the *Measuring point of case temperature T_C* (see: *Mechanical Data*) will approach the indicated value $T_{C max}$ after the warm-up phase. However, the relationship between T_A and T_C depends heavily on the conditions of operation and integration into a system. The thermal conditions are influenced by input voltage, output current, airflow, temperature of surrounding components and surfaces and the properties of the printed circuit board. $T_{A max}$ is therefore only an indicative value and under practical operating conditions, the admissible ambient temperature T_A may be higher or lower than this value.

Caution: The case temperature T_C measured at the *Measuring point of case temperature T_C* (see: *Mechanical Data*) must under no circumstances exceed the specified maximum value. The installer must ensure that under all operating conditions T_C remains within the limits stated in the table: *Temperature specifications*.

Short Circuit Behaviour

The current limit characteristic shuts down the converter whenever a short circuit or an overload is applied to its output. It acts self-protecting and automatically recovers after removal of the overload condition (hiccup mode).

Overtemperature Protection

The converters are protected from possible overheating by means of an internal non latching temperature monitoring circuit. It shuts down the unit above the internal temperature limit and attempts to automatically restart in short periods. This feature prevents excessive internal temperature excursion which could occur in heavy overload conditions.

Extendable output power characterisation of 48IMS30-0302-9G under forced air condition

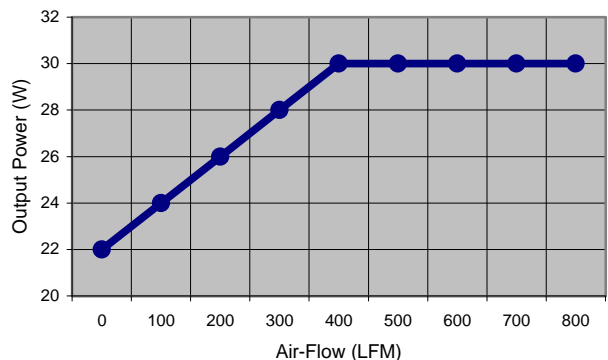

Electromagnetic Compatibility (EMC)

A suppressor diode together with an input filter form an effective protection against high input transient voltages

which typically occur in many installations, but especially in battery driven mobile applications.

Electromagnetic Immunity

Table 8: Immunity type tests

Phenomenon	Standard ¹	Class Level	Coupling mode ²	Value applied	Waveform	Source Imped.	Test procedure	In oper.	Per-form. ³
Electrostatic discharge to case	IEC/EN 61000-4-2	2	contact discharge	4000 V _p	1/50 ns	330	10 positive and 10 negative discharges	yes	B
		3	air discharge	8000 V _p					
Electromagnetic field	IEC/EN 61000-4-3	2	antenna	3 V/m	AM 80% 1 kHz		26...1000 MHz	yes	A
	ENV 50204				PM, 50% duty cycle, 200 Hz resp. frequ.		900 MHz		
Electrical fast transient/burst	IEC/EN 61000-4-4	3	direct +i/-i	2000 V _p	bursts of 5/50 ns 5 kHz rep. rate transients with 15 ms burst duration and a 300 ms period	50	1 min positive 1 min negative transients per coupling mode	yes	A
Surge	IEC/EN 61000-4-5 ⁵	2	+i/-i	1000 V _p	1.2/50 s	2	5 pos. and 5 neg. impulses per coupling mode	yes	B
Conducted disturbances	IEC/EN 61000-4-6	2	+i/-i	3V _{rms} (130 dB _V)	AM modulated 80%, 1 kHz	50	0.15...80 MHz 150	yes	A
Transient	ETR 283 (19 Pfl 1) ⁴		+i/-i	150 V _p	0.1/0.3 ms	limited to <100 A	3 positive	yes	B

¹ Related and previous standards are referenced in: *Technical Information: Standards.*

² i = input, o = output.

³ A = normal operation, no deviation from specification, B = temporary deviation from specs. possible.

⁴ For 48 IMS 30 types (additional external components required).

⁵ External components required.

Electromagnetic Emission

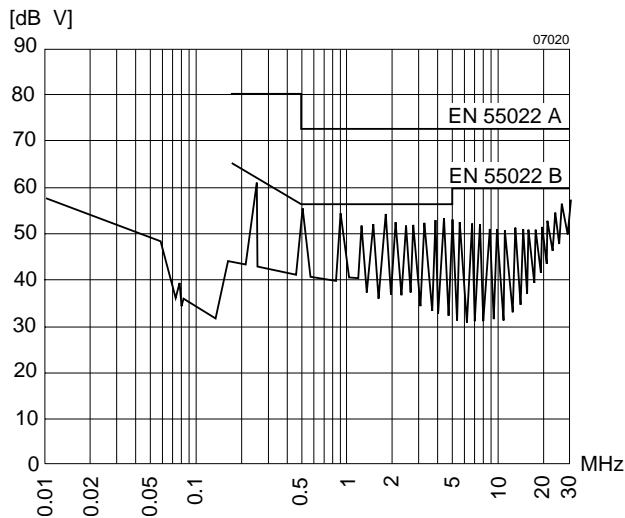

Fig. 10

Typical disturbance voltage (quasi-peak) at the input according to CISPR 11/EN 55011 and CISPR 22/EN 55022, measured at $U_{i\text{nom}}$ and $I_{o\text{nom}}$. Output leads 10 cm, twisted. (48 IMS30-0503-9G)

Immunity to Environmental Conditions

Table 9: Mechanical stress

Test method		Standard	Test conditions		Status
Ca	Damp heat steady state	IEC/DIN IEC 60068-2-3 MIL-STD-810D section 507.2	Temperature: Relative humidity: Duration:	40 ² C 93 ^{+2/-3} % 56 days	Unit not operating
Ea	Shock (half-sinusoidal)	IEC/EN/DIN EN 60068-2-27 MIL-STD-810D section 516.3	Acceleration amplitude: Bump duration: Number of bumps:	50 g _n = 490 m/s ² 11 ms 18 (3 each direction)	Unit operating
Eb	Bump (half-sinusoidal)	IEC/EN/DIN EN 60068-2-29 MIL-STD-810D section 516.3	Acceleration amplitude: Bump duration: Number of bumps:	25 g _n = 245 m/s ² 11 ms 6000 (1000 each direction)	Unit operating
Fc	Vibration (sinusoidal)	IEC/EN/DIN EN 60068-2-6 MIL-STD-810D section 514.3	Acceleration amplitude: Frequency (1 Oct/min): Test duration:	0.35 mm (10...60 Hz) 5 g _n = 49 m/s ² (60...2000 Hz) 10...2000 Hz 7.5 h (2.5 h each axis)	Unit operating
Kb	Salt mist, cyclic (sodium chloride NaCl solution)	IEC/EN/DIN IEC 60068-2-52	Concentration: Duration: Storage: Storage duration: Number of cycles:	5% (30 C) 2 h per cycle 40 C, 93% rel. humidity 22 h per cycle 3	Unit not operating

Table 10: Temperature specifications, valid for air pressure of 800...1200 hPa (800...1200 mbar)

Temperature		Standard -9G		Unit
Characteristics	Conditions	min	max	
T _A	Ambient temperature ¹	Operational	-40	°C
T _C	Case temperature		-40	
T _S	Storage temperature ¹	Non operational	-55	

¹ MIL-STD-810D section 501.2 and 502.2

Table 11: MTBF

Values at specified case temperature	Type	Ground benign	Ground fixed		Ground mobile	Device hours	Unit
		25 C	25 C	55 C	55 C		
MTBF	48 IMS 30-0503-9G	927'229	331'251	179'831	272'260	n.a.	h

¹ Statistical values based on an average of 4300 working hours per year and in general field use, over 2 years.

Mechanical Data

Dimensions in mm. Tolerances ± 0.3 mm unless otherwise indicated.

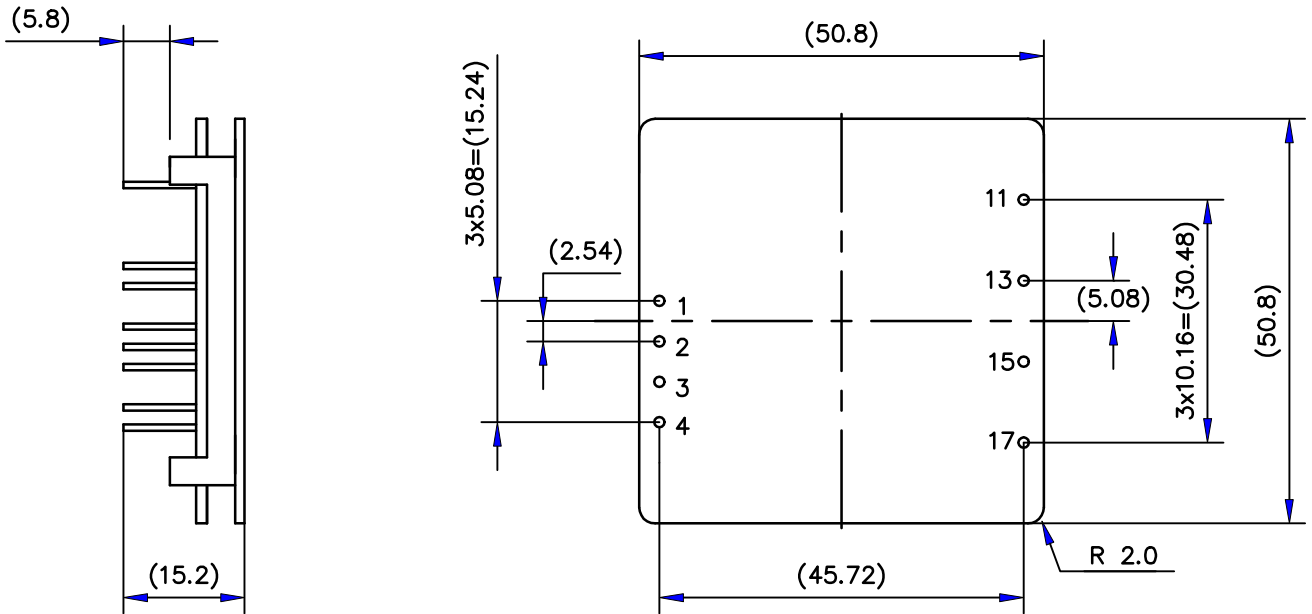

Bottom View

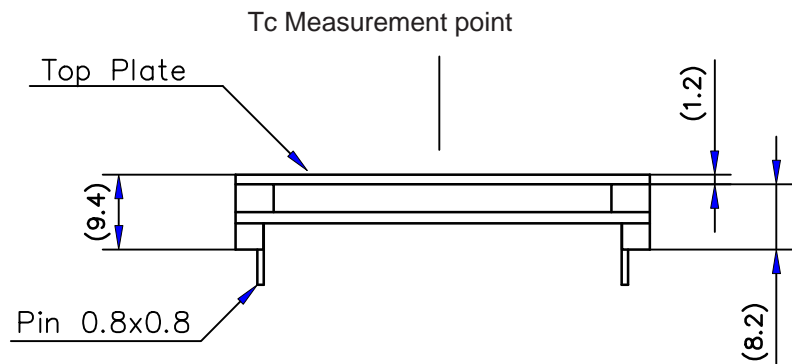

-0503, -0302 Outputs

Pin No.	Description
1	Vi+
2	Vi-
3	sync
4	SD
11	Uo 2
12	No Pin
13	Uo 1
14	No Pin
15	Com
16	No Pin
17	Trim

Safety and Installation Instructions

Installation Instruction

Installation of the DC-DC converters must strictly follow the national safety regulations in compliance with the enclosure, mounting, creepage, clearance, casualty, markings and segregation requirements of the end-use application.

Connection to the system shall be made via a printed circuit board with hole diameters of 1.4 mm 0.1 mm for the pins.

The units should be connected to a secondary circuit.

Check for hazardous voltages before altering any connections.

Do not open the module.

Ensure that a unit failure (e.g. by an internal short-circuit) does not result in a hazardous conditions. See also: *Safety of operator accessible output circuit*.

Input Fuse

To prevent excessive current flowing through the input supply line in case of a short-circuit across the converter input an external fuse should be installed in a non earthed input supply line. We recommend a fast acting fuse F3.15A for 48 IMS 30 types.

Standards and approvals

All DC-DC converters are pending to be UL recognized according to UL 1950, UL recognized for Canada to CAN/CSA C22.2 No. 950-95 and LGA approved to IEC/EN 60950 standards.

The units have been evaluated for:

- Building in
- Supplementary insulation input to output, based on their maximum input voltage
- The use in a pollution degree 2 environment
- Connecting the input to a secondary circuit which is subject to a maximum transient rating of 1500 V

After approvals the DC-DC converters are subject to manufacturing surveillance in accordance with the above mentioned UL, CSA, EN and ISO 9001 standards.

Isolation

The electric strength test is performed as factory test in accordance with IEC/EN 60950 and UL 1950 and should not be repeated in the field. Melcher will not honour any guarantee claims resulting from electric strength field tests.

Table 12: Electric strength test voltages

Characteristic	Input to output	Unit
Electric strength test voltage 1 s	1.1	kV _{rms}
	1.5	kV DC
Coupling capacitance	2.2	nF
Insulation resistance at 500 V DC	>100	M
Partial discharge extinction voltage	Consult factory	kV

Protection Degree

The protection degree of the DC-DC converters is IP 40.

Cleaning Agents

In order to avoid possible damage, any penetration of cleaning fluids should be prevented, since the power supplies are not hermetically sealed.

Safety of Operator Accessible Output Circuit

If the output circuit of a DC-DC converter is operator accessible, it shall be an SELV circuit according to IEC/EN 60950 related safety standards

The following table shows some possible installation configurations, compliance with which causes the output circuit of the DC-DC converter to be an SELV circuit according to IEC/EN 60950 up to a configured output voltage of 42 V.

However, it is the sole responsibility of the installer to ensure the compliance with the relevant and applicable safety regulations. More information is given in: *Technical Information: Safety*.

Table 14: Insulation concept leading to an SELV output circuit

Conditions	Front end			DC-DC converter	Result
Supply voltage	Minimum required grade of isolation, to be provided by the AC-DC front end, including mains supplied battery charger	Maximum DC output voltage from the front end ¹	Minimum required safety status of the front end output circuit	Measures to achieve the specified safety status of the output circuit	Safety status of the DC-DC converter output circuit
Mains 250 V AC	Basic	60 V	Earthed SELV circuit ²	Operational insulation (provided by the DC-DC converter)	SELV circuit
		>60 V	Hazardous voltage secondary circuit	Input fuse ³ output suppressor diode(s) ⁴ , and earthed output circuit(s) ²	Earthed SELV circuit
	Double or reinforced	60 V	SELV circuit	Operational insulation (provided by the DC-DC converter)	SELV circuit
		>60 V	TNV-2 circuit Double or reinforced insulated unearthed hazardous voltage secondary circuit ⁵	Supplementary insulation, based on the maximum input voltage (provided by the DC-DC converter)	

- ¹ The front end output voltage should match the specified input voltage range of the DC-DC converter.
- ² The earth connection has to be provided by the installer according to the relevant safety standard, e.g. IEC/EN 60950.
- ³ The installer shall provide an approved fuse (type with the lowest rating suitable for the application) in a non-earthed input line directly at the input of the DC-DC converter (see fig.: *Schematic safety concept*). For UL's purpose, the fuse needs to be UL-listed. See also: *Input Fuse*.
- ⁴ Each suppressor diode should be dimensioned in such a way, that in the case of an insulation fault the diode is able to limit the output voltage to SELV (<60 V) until the input fuse blows (see fig.: *Schematic safety concept*).
- ⁵ Has to be insulated from earth by basic insulation according to the relevant safety standard, based on the maximum output voltage from the front end.

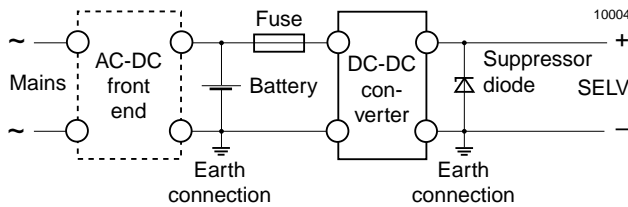

Fig. 13 Schematic safety concept. Use fuse, suppressor diode and earth connection as per table: Safety concept leading to an SELV output circuit.

Description of Option

Option i Inhibit

Excludes shut down

The output(s) of the converter may be enabled or disabled by means of a logic signal (TTL, CMOS, etc.) applied to the inhibit pin. No output voltage overshoot will occur when the unit is turned on. If the inhibit function is not required the inhibit pin should be connected to Vi- to enable the output (active low logic, fail safe).

Converter operating: -10 V...0.8 V
 Converter inhibited or inhibit pin left open circuit 2.4...5 V

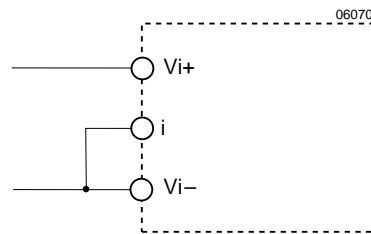

Fig. 14 If the inhibit is not used the inhibit pin should be connected to Vi-