

Low Power J-FET DUAL OPERATIONAL AMPLIFIERS

IL062

The IL062 is high speed J-FET input dual operational amplifier. This J-FET input operational amplifier incorporates well matched, high voltage J-FET and bipolar transistors in a monolithic integrated circuit. The devices feature high slew rates, low input bias and offset currents, and low offset voltage temperature coefficient.

- Operation Very low power consumption: 200 μ A
- Wide common-mode (up to V_{CC}^+) and differential voltage ranges
- Low input bias and offset currents
- Output short-circuit protection
- High input impedance J-FET input stage
- Internal frequency compensation
- Latch up free operation
- High slew rate: 3.5V/s

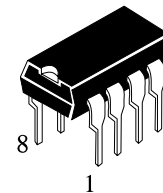

N SUFFIX
PLASTIC

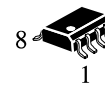

D SUFFIX
SOIC

ORDERING INFORMATION

IL062N Plastic

IL062D SOIC

$T_A = -40^\circ$ to 85°C for package

Pin Connections (top view)

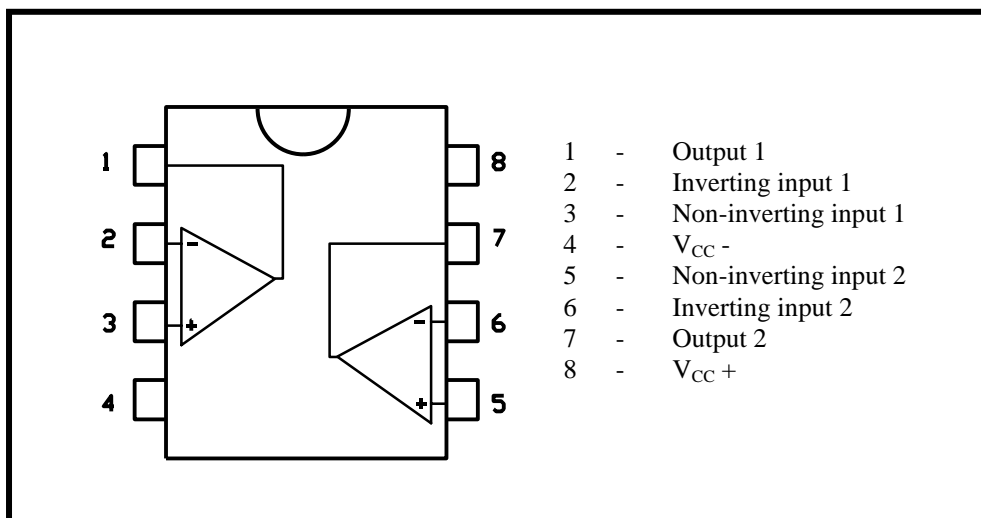

SCHEMATIC DIAGRAM

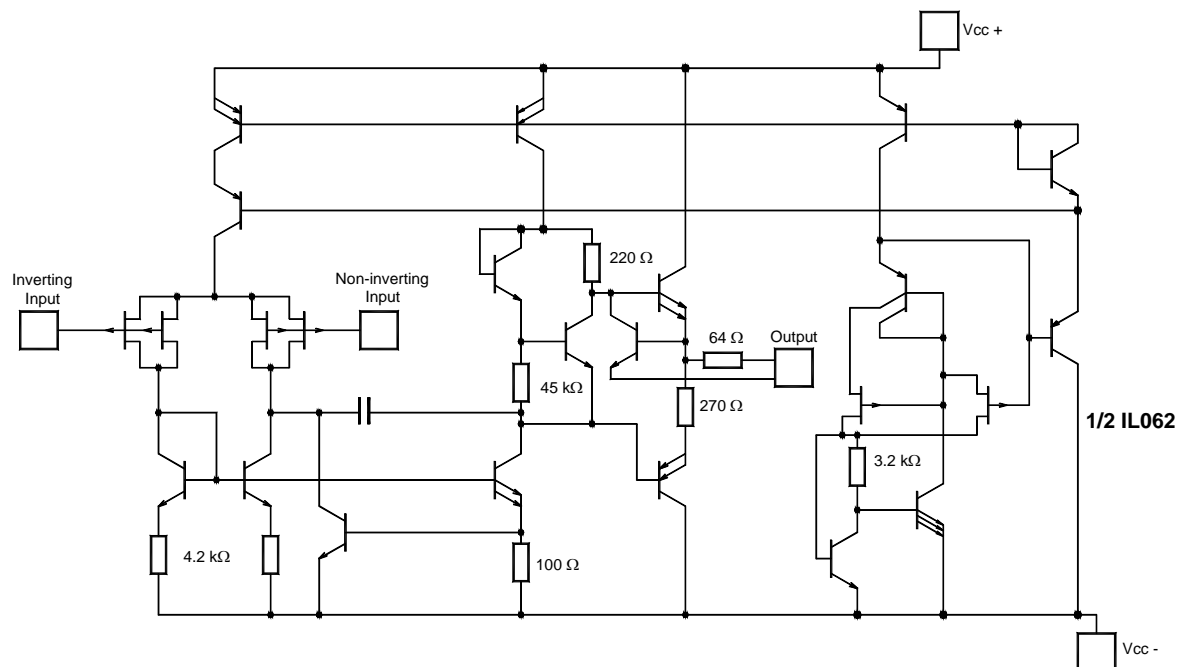

MAXIMUM RATING

Symbol	Parameter	IL062	Unit
V_{CC}	Supply Voltage – (note 1)	18	V
V_i	Input Voltage – (note 3)	15	V
V_{id}	Differential Input Voltage – (note 2)	30	V
P_{tot}	Power Dissipation	680	mW
	Output Short-Circuit Duration (Note 4)	Infinite	
T_{oper}	Operating Free-Air Temperature Range	-40 to +85	°C
T_{stg}	Storage Temperature Range	-65 to +150	°C

- Notes
1. All voltage values, except differential voltage, are with respect to the zero reference level (ground) of the supply voltages where the zero reference level is the midpoint between V_{CC}^+ and V_{CC}^- .
 2. Differential voltages are at the non-inverting input terminal with respect to the inverting input terminal.
 3. The magnitude of the input voltage must never exceed the magnitude of the supply voltage or 15 volts, whichever is less.
 4. The output may be shorted to ground or to either supply. Temperature and/or supply voltages must be limited to ensure that the dissipation rating is not exceeded.

ELECTRICAL CHARACTERISTICS
 $V_{CC} = \pm 15V$, $T_{AMB} = 25^{\circ}C$ (unless otherwise specified)

Symbol	Parameters	IL062			Unit
		Min.	Typ.	Max.	
V_{IO}	Input Offset Voltage ($R_S = 50\Omega$) $T_{amb} = 25^{\circ}C$ $T_{min.} \leq T_{amb.} \leq T_{max.}$		3	15 20	mV
DV_{IO}	Temperature Coefficient of Input Offset Voltage ($R_S = 50\Omega$)		10		$\mu V/^{\circ}C$
I_{IO}	Input Offset Current* $T_{amb} = 25^{\circ}C$ $T_{min.} \leq T_{amb.} \leq T_{max.}$		5	200 5	pA nA
I_{IB}	Input Bias Current* $T_{amb} = 25^{\circ}C$ $T_{min.} \leq T_{amb.} \leq T_{max.}$		30	400 10	pA nA
V_{ICM}	Input Common Mode Voltage Range	± 11	+15 -12		V
V_{OPP}	Output Voltage Swing ($R_L = 10k\Omega$) $T_{amb} = 25^{\circ}C$ $T_{min.} \leq T_{amb.} \leq T_{max.}$	20 20	27		V
A_{VD}	Large Signal Voltage Gain ($R_L = 10k\Omega$, $V_O = \pm 10V$) $T_{amb} = 25^{\circ}C$ $T_{min.} \leq T_{amb.} \leq T_{max.}$	3 3	6		V/mV
GBP	Gain Bandwidth Product ($T_{amb} = 25^{\circ}C$, $R_L = 10k\Omega$, $C_L = 100pF$)		1		MHz
R_I	Input Resistance		10^{12}		Ω
CMR	Common Mode Rejection Ratio ($R_S = 50\Omega$)	70	76		dB
SVR	Supply Voltage Rejection Ratio ($R_S = 50\Omega$)	70	95		dB
I_{CC}	Supply Current (Per Amplifier) ($T_{amb} = 25^{\circ}C$, no load, no signal)		200	250	A
V_{O1}/V_{O2}	Channel Separation ($A_V = 100$, $T_{amb} = 25^{\circ}C$)		120		dB
P_D	Total Power Consumption (Each Amplifier) ($T_{amb} = 25^{\circ}C$, no load, no signal)		6	7.5	mW
SR	Slew Rate ($V_i = 10V$, $R_L = 10k\Omega$, $C_L = 100pF$, $A_V = 1$)	1.5	3.5		V/ μs
tr	Rise Time ($V_i = 20mV$, $R_L = 10k\Omega$, $C_L = 100pF$, $A_V = 1$)		0.2		μs
KOV	Overshoot Factor ($V_i = 20mV$, $R_L = 10k\Omega$, $C_L = 100pF$, $A_V = 1$) (see figure 1)		10		%
en	Equivalent input Noise Voltage ($R_S = 100\Omega$, $f = 1KHz$)		42		$\frac{nV}{\sqrt{Hz}}$

* Input bias currents of a FET- input operational amplifier are normal junction reverse currents, which are temperature sensitive.

Pulse techniques must be used that will maintain the junction temperature as close to the ambient temperature as possible.

MAXIMUM PEAK-TO-PEAK OUTPUT VOLTAGE versus SUPPLY VOLTAGE

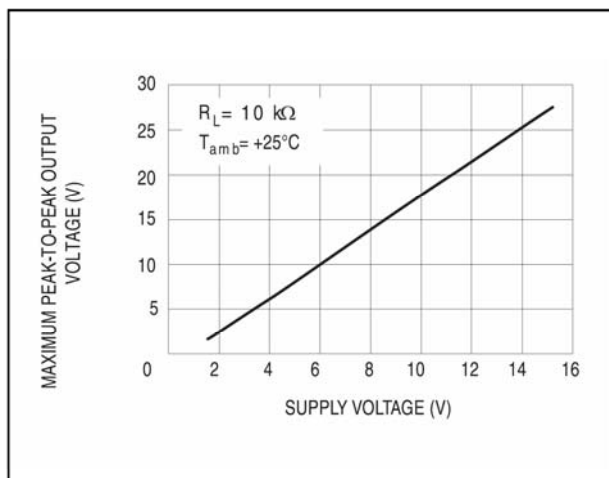

MAXIMUM PEAK-TO-PEAK OUTPUT VOLTAGE versus FREE AIR TEMP.

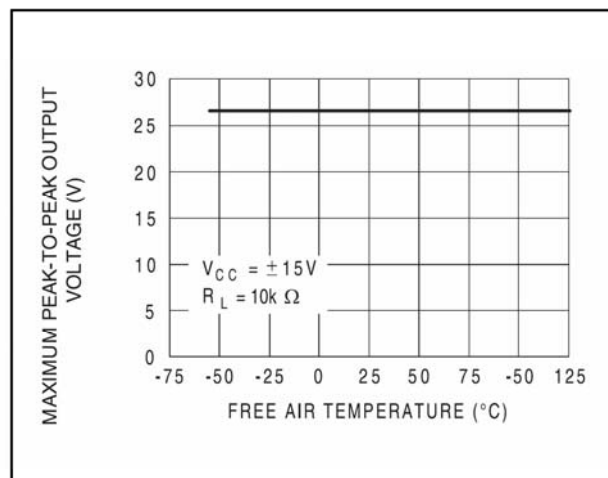

MAXIMUM PEAK-TO-PEAK OUTPUT VOLTAGE versus LOAD FREQUENCY

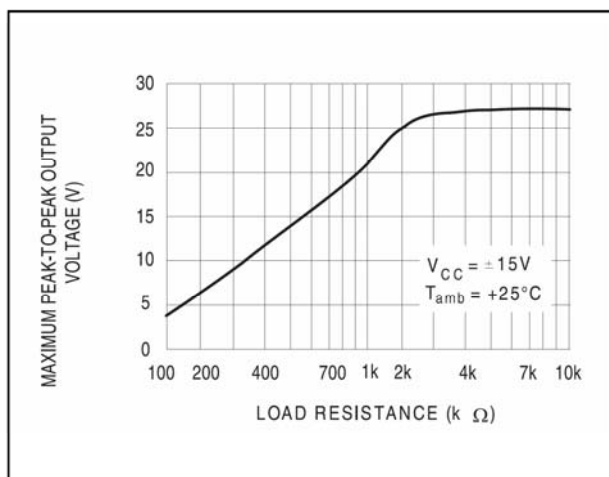

MAXIMUM PEAK-TO-PEAK OUTPUT VOLTAGE versus FREQUENCY

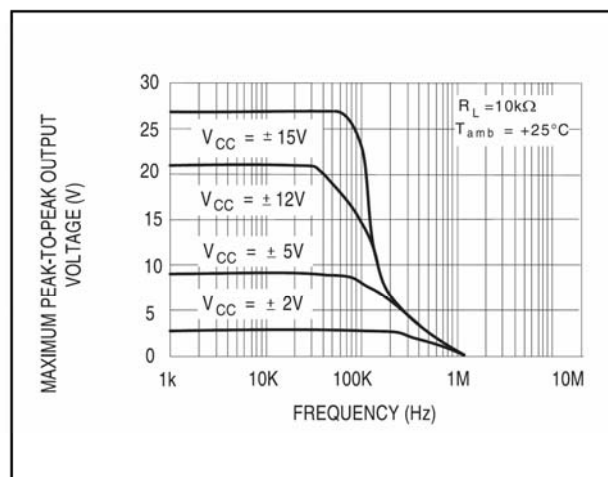

DIFFERENTIAL VOLTAGE AMPLIFICATION versus FREE AIR TEMPERATURE

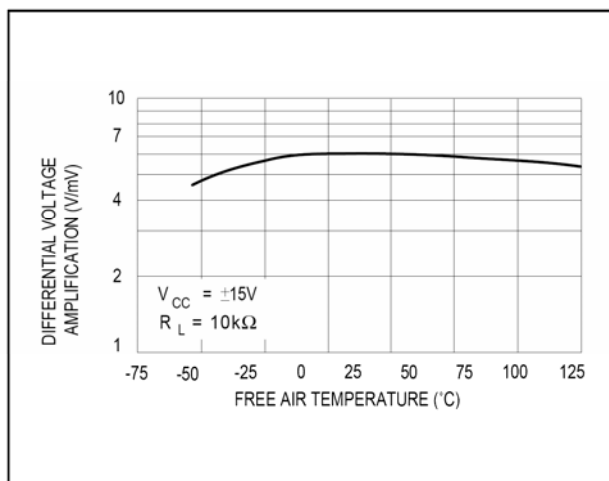

LARGE SIGNAL DIFFERENTIAL VOLTAGE AMPLIFICATION AND PHASE SHIFT versus FREQUENCY

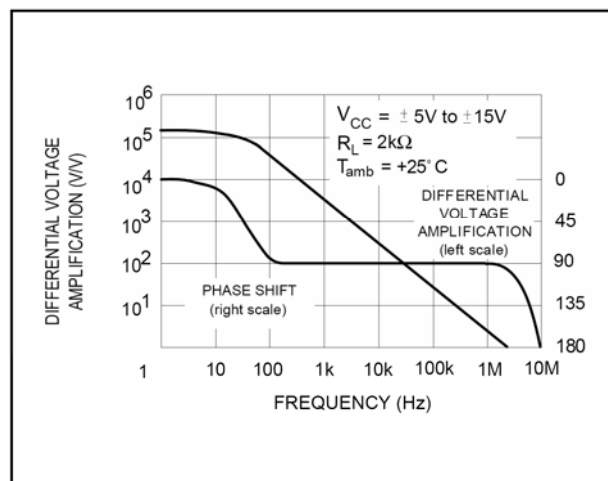

SUPPLY CURRENT PER AMPLIFIER versus SUPPLY VOLTAGE

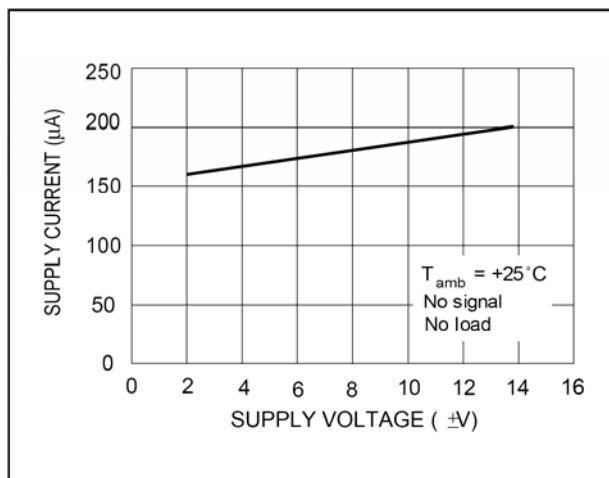

SUPPLY CURRENT PER AMPLIFIER versus FREE AIR TEMPERATURE

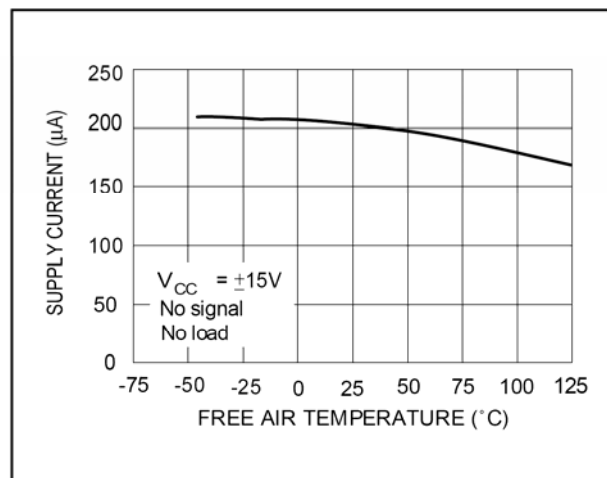

TOTAL POWER DISSIPATED versus FREE AIR TEMPERATURE

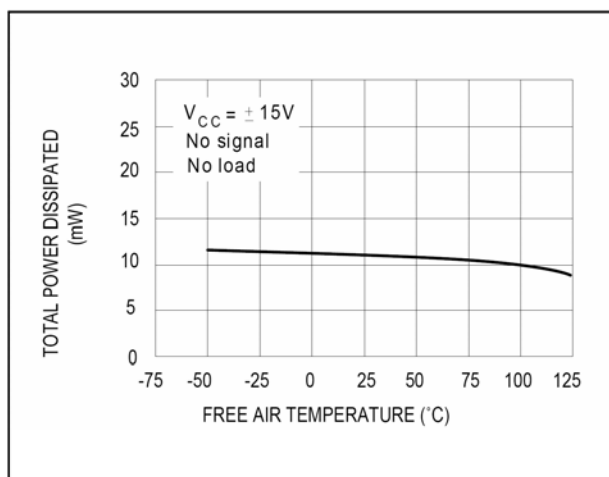

COMMON MODE REJECTION RATIO versus FREE AIR TEMPERATURE

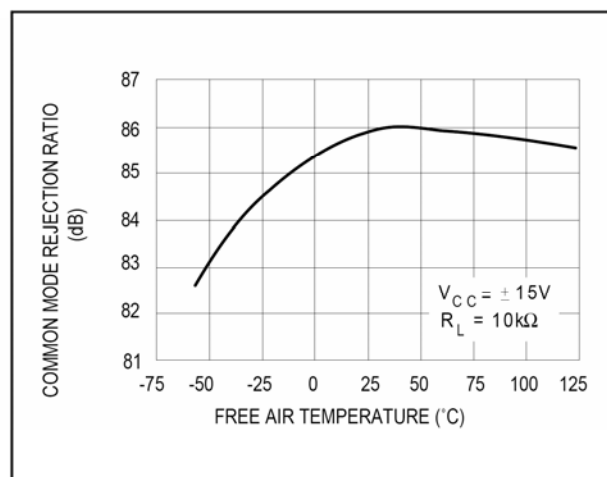

NORMALIZED UNITY GAIN BANDWIDTH, SLEW RATE, AND PHASE SHIFT versus TEMPERATURE

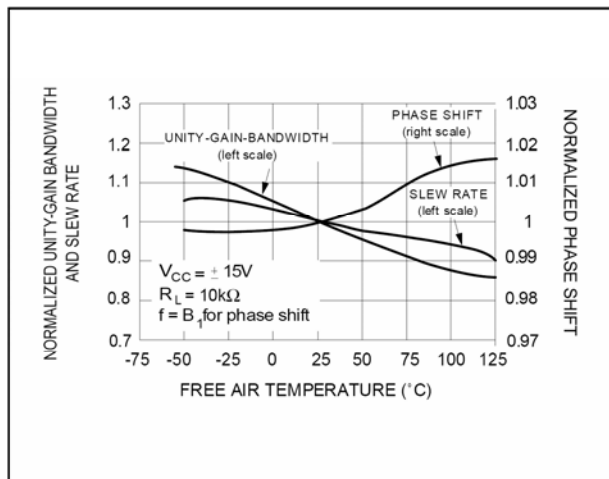

INPUT BIAS CURRENT versus FREE AIR TEMPERATURE

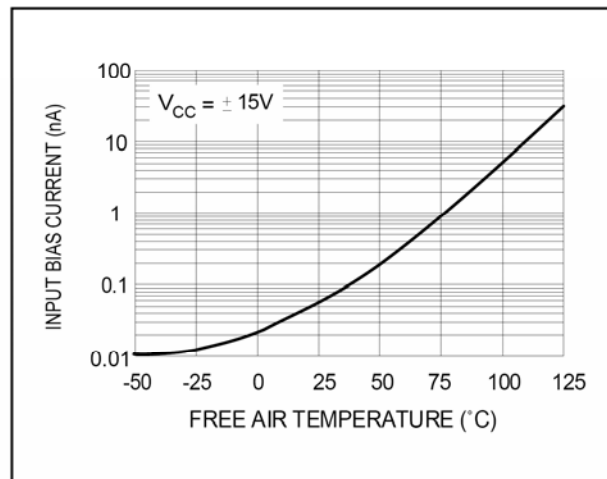

VOLTAGE FOLLOWER LARGE SIGNAL PULSE RESPONSE

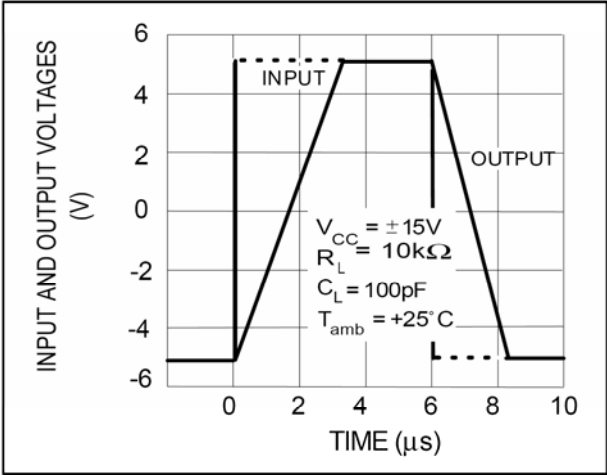

OUTPUT VOLTAGE versus ELAPSED TIME

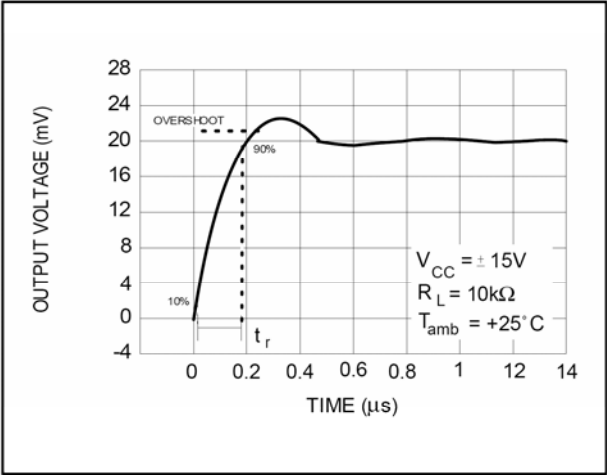

EQUIVALENT INPUT NOISE VOLTAGE versus FREQUENCY

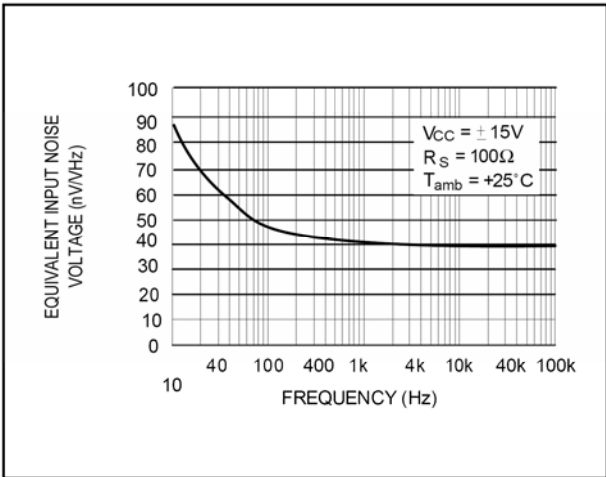

**N SUFFIX PLASTIC DIP
(MS - 001BA)**

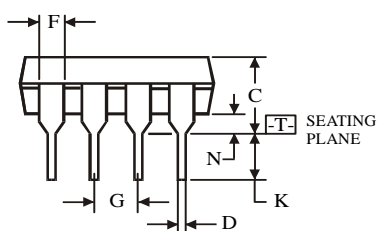
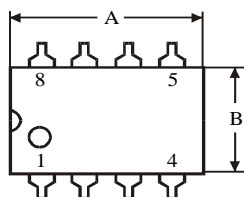
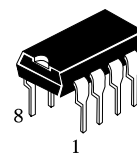

$\oplus 0.25 (0.010) \text{ (M) T}$

Symbol	Dimension, mm	
	MIN	MAX
A	8.51	10.16
B	6.1	7.11
C		5.33
D	0.36	0.56
F	1.14	1.78
G	2.54	
H	7.62	
J	0°	10°
K	2.92	3.81
L	7.62	8.26
M	0.2	0.36
N	0.38	

NOTES:

- Dimensions "A", "B" do not include mold flash or protrusions.
Maximum mold flash or protrusions 0.25 mm (0.010) per side.

**D SUFFIX SOIC
(MS - 012AA)**

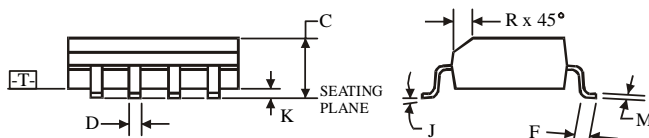
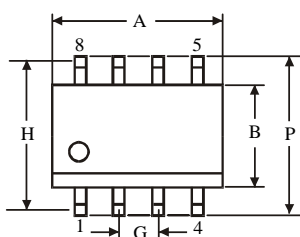
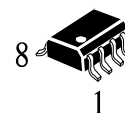

$\oplus 0.25 (0.010) \text{ (M) T C (M)}$

Symbol	Dimension, mm	
	MIN	MAX
A	4.8	5
B	3.8	4
C	1.35	1.75
D	0.33	0.51
F	0.4	1.27
G	1.27	
H	5.72	
J	0°	8°
K	0.1	0.25
M	0.19	0.25
P	5.8	6.2
R	0.25	0.5

NOTES:

- Dimensions A and B do not include mold flash or protrusion.
- Maximum mold flash or protrusion 0.15 mm (0.006) per side for A; for B - 0.25 mm (0.010) per side.