



GENERAL DESCRIPTION



The ICS840051I is a Gigabit Ethernet Clock Generator and a member of the HiPerClocks™ family of high performance devices from ICS. The ICS840051I can synthesize 10 Gigabit Ethernet, SONET, or Serial ATA reference clock frequencies with the appropriate choice of crystal and output divider. The ICS840051I has excellent phase jitter performance and is packaged in a small 8-pin TSSOP, making it ideal for use in systems with limited board space.

FEATURES

- 1 LVCMOS/LVTTL output, 15Ω output impedance
- Crystal oscillator interface designed for 18pF parallel resonant crystals
- Output frequency range: 70MHz - 170MHz
- VCO range: 560MHz - 680MHz
- RMS phase jitter at 155.52MHz (1.875MHz - 20MHz): 0.48ps (typical)
- RMS phase noise at 155.52MHz

Offset Noise Power

100Hz	-99.7 dBc/Hz
1KHz	-120 dBc/Hz
10KHz	-128 dBc/Hz
100KHz	-127 dBc/Hz

- 3.3V or 2.5V operating supply
- -40°C to 85°C ambient operating temperature
- Lead-Free fully RoHS compliant

FREQUENCY TABLE

Inputs		Output Frequency (MHz)
Crystal Frequency (MHz)	FREQ_SEL	
20.141601	0	161.132812
20.141601	1	80.566406
19.53125	0	156.25
19.53125	1	78.125
19.44	0	155.52
19.44	1	77.76
18.75	0	150
18.75	1	75

BLOCK DIAGRAM

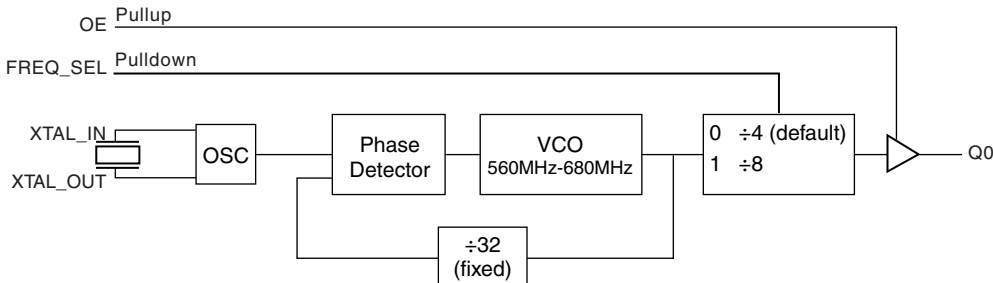

PIN ASSIGNMENT

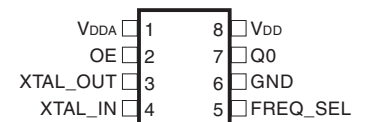

ICS840051I

8-Lead TSSOP
4.40mm x 3.0mm x 0.925mm
package body
G Package
Top View



TABLE 1. PIN DESCRIPTIONS

Number	Name	Type		Description
1	V _{DDA}	Power		Analog supply pin.
2	OE	Input	Pullup	Output enable pin. When HIGH, Q0 output is enabled. When LOW, forces Q0 to HiZ state. LVCMOS/LVTTL interface levels. See Table 3A.
3, 4	XTAL_OUT, XTAL_IN	Input		Crystal oscillator interface. XTAL_IN is the input, XTAL_OUT is the output.
5	FREQ_SEL	Input	Pulldown	Frequency select pin. LVCMOS/LVTTL interface levels. See Table 3B.
6	GND	Power		Power supply ground.
7	Q0	Output		Single-ended clock output. LVCMOS/LVTTL interface levels. 15Ω output impedance.
8	V _{DD}	Power		Core supply pin.

NOTE: *Pullup and Pulldown* refer to internal input resistors. See Table 2, Pin Characteristics, for typical values.

TABLE 2. PIN CHARACTERISTICS

Symbol	Parameter	Test Conditions	Minimum	Typical	Maximum	Units
C _{IN}	Input Capacitance			4		pF
C _{PD}	Power Dissipation Capacitance	V _{DD} , V _{DDA} = 3.465V		7		pF
		V _{DD} , V _{DDA} = 2.625V		7		pF
R _{PULLUP}	Input Pullup Resistor			51		KΩ
R _{PULLDOWN}	Input Pulldown Resistor			51		KΩ
R _{OUT}	Output Impedance			15		Ω

TABLE 3A. CONTROL FUNCTION TABLE

Control Input	Output
OE	Q0
0	Hi-Z
1	Active

TABLE 3B. FREQ_SEL FUNCTION TABLE

Control Input	N Divider
FRE_SEL	
0	÷4 (default)
1	÷8



ABSOLUTE MAXIMUM RATINGS

Supply Voltage, V_{DD}	4.6V
Inputs, V_i	-0.5V to $V_{DD} + 0.5V$
Outputs, V_o	-0.5V to $V_{DD} + 0.5V$
Package Thermal Impedance, θ_{JA}	101.7°C/W (0 mps)
Storage Temperature, T_{STG}	-65°C to 150°C

NOTE: Stresses beyond those listed under Absolute Maximum Ratings may cause permanent damage to the device. These ratings are stress specifications only. Functional operation of product at these conditions or any conditions beyond those listed in the *DC Characteristics* or *AC Characteristics* is not implied. Exposure to absolute maximum rating conditions for extended periods may affect product reliability.

TABLE 4A. POWER SUPPLY DC CHARACTERISTICS, $V_{DD} = V_{DDA} = 3.3V \pm 5\%$, $T_A = -40^\circ C$ TO $85^\circ C$

Symbol	Parameter	Test Conditions	Minimum	Typical	Maximum	Units
V_{DD}	Core Supply Voltage		3.135	3.3	3.465	V
V_{DDA}	Analog Supply Voltage		3.135	3.3	3.465	V
I_{DD}	Power Supply Current				60	mA
I_{DDA}	Analog Supply Current				10	mA

TABLE 4B. POWER SUPPLY DC CHARACTERISTICS, $V_{DD} = V_{DDA} = 2.5V \pm 5\%$, $T_A = -40^\circ C$ TO $85^\circ C$

Symbol	Parameter	Test Conditions	Minimum	Typical	Maximum	Units
V_{DD}	Core Supply Voltage		2.375	2.5	2.625	V
V_{DDA}	Analog Supply Voltage		2.375	2.5	2.625	V
I_{DD}	Power Supply Current				55	mA
I_{DDA}	Analog Supply Current				10	mA

TABLE 4C. LVCMOS/LVTTL DC CHARACTERISTICS, $V_{DD} = V_{DDA} = 3.3V \pm 5\%$, $T_A = -40^\circ C$ TO $85^\circ C$

Symbol	Parameter	Test Conditions	Minimum	Typical	Maximum	Units
V_{IH}	Input High Voltage		2		$V_{DD} + 0.3$	V
V_{IL}	Input Low Voltage		-0.3		0.8	V
I_{IH}	Input High Current	FREQ_SEL $V_{DD} = V_{IN} = 3.465V$ or $2.625V$			150	μA
		OE $V_{DD} = V_{IN} = 3.465V$ or $2.625V$			5	μA
I_{IL}	Input Low Current	FREQ_SEL $V_{DD} = 3.465V$ or $2.625V$, $V_{IN} = 0V$	-5			μA
		OE $V_{DD} = 3.465V$ or $2.625V$, $V_{IN} = 0V$	-150			μA
V_{OH}	Output High Voltage; NOTE 1	$V_{DD} = 3.465V$	2.6			V
		$V_{DD} = 2.625V$	1.8			V
V_{OL}	Output Low Voltage; NOTE 1	$V_{DD} = 3.465V$ or $2.625V$			0.5	V

NOTE 1: Outputs terminated with 50Ω to $V_{DD}/2$. See Parameter Measurement Information Section, "Output Load Test Circuit" diagrams.



TABLE 5. CRYSTAL CHARACTERISTICS

Parameter	Test Conditions	Minimum	Typical	Maximum	Units
Mode of Oscillation		Fundamental			
Frequency		17.5		21.25	MHz
Equivalent Series Resistance (ESR)				50	Ω
Shunt Capacitance				7	pF

TABLE 6A. AC CHARACTERISTICS, $V_{DD} = V_{DDA} = 3.3V \pm 5\%$, $T_A = -40^\circ\text{C}$ TO 85°C

Symbol	Parameter	Test Conditions	Minimum	Typical	Maximum	Units
f_{OUT}	Output Frequency		70		170	MHz
$f_{jit}(\emptyset)$	RMS Phase Jitter (Random); NOTE 1	155.52MHz, Integration Range: 1.875MHz - 20MHz		0.48		ps
t_R / t_F	Output Rise/Fall Time	20% to 80%	150		500	ps
odc	Output Duty Cycle		48		52	%

NOTE 1: Please refer to the Phase Noise Plots.

TABLE 6B. AC CHARACTERISTICS, $V_{DD} = V_{DDA} = 2.5V \pm 5\%$, $T_A = -40^\circ\text{C}$ TO 85°C

Symbol	Parameter	Test Conditions	Minimum	Typical	Maximum	Units
f_{OUT}	Output Frequency		70		170	MHz
$f_{jit}(\emptyset)$	RMS Phase Jitter (Random); NOTE 1	155.52MHz, Integration Range: 1.875MHz - 20MHz		0.50		ps
t_R / t_F	Output Rise/Fall Time	20% to 80%	200		600	ps
odc	Output Duty Cycle		49		51	%

NOTE 1: Please refer to the Phase Noise Plots.



TYPICAL PHASE NOISE AT 155.52MHz (3.3V)

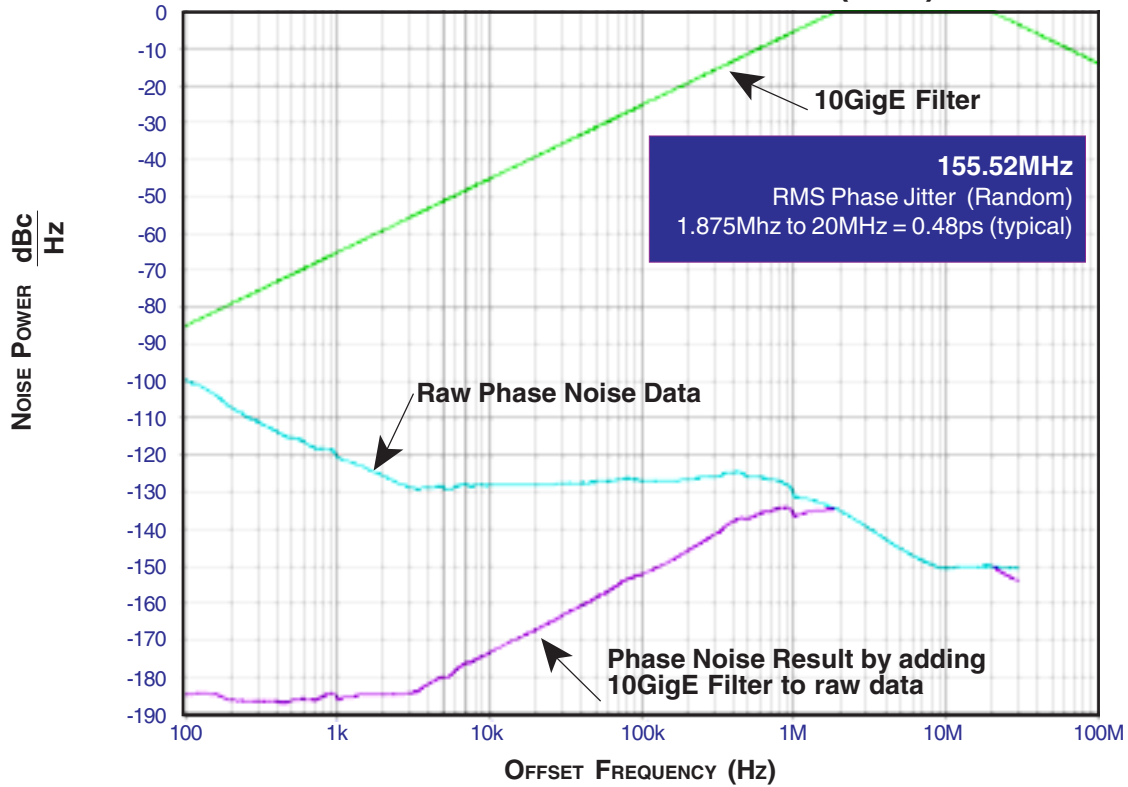

TYPICAL PHASE NOISE AT 155.52MHz (2.5V)

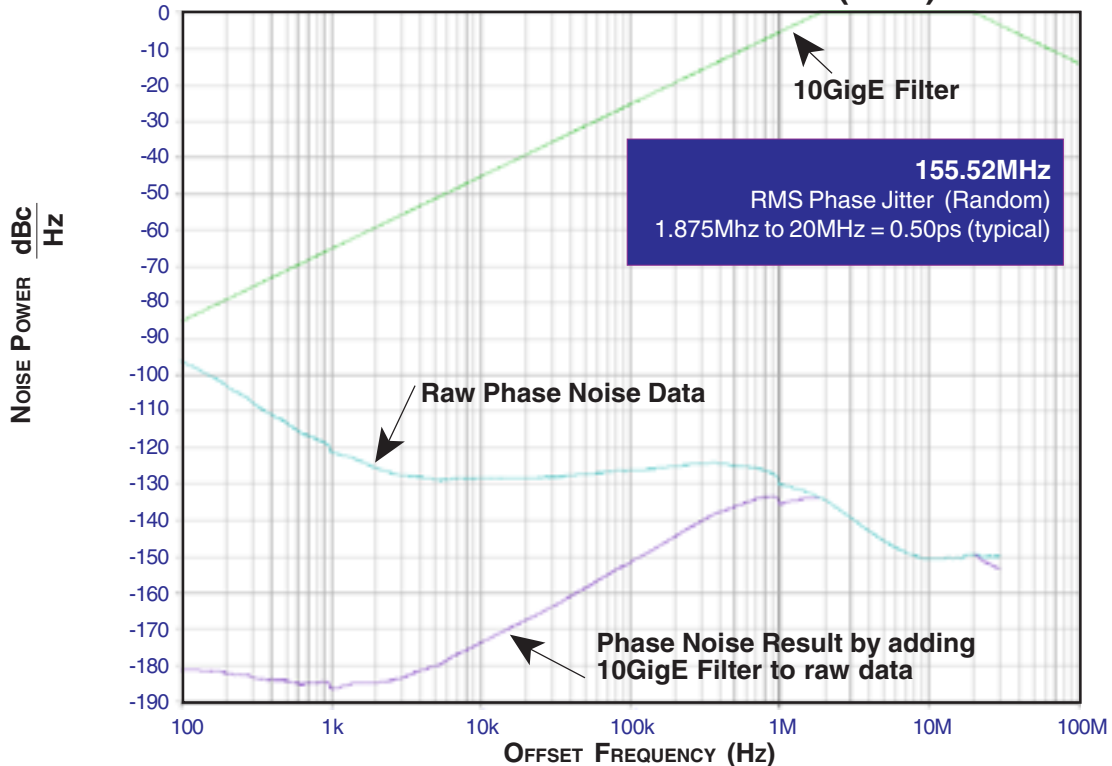



PARAMETER MEASUREMENT INFORMATION

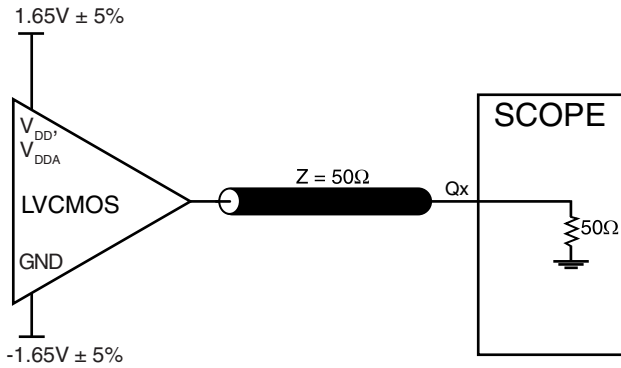

3.3V CORE/3.3V OUTPUT LOAD AC TEST CIRCUIT

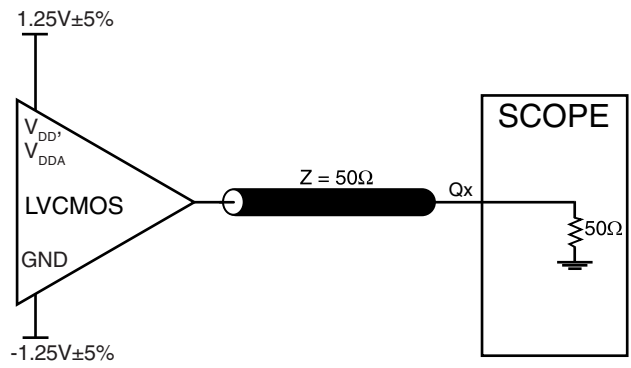

2.5V CORE/2.5V OUTPUT LOAD AC TEST CIRCUIT

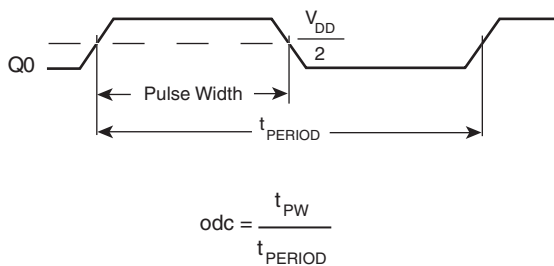

OUTPUT DUTY CYCLE/PULSE WIDTH/PERIOD

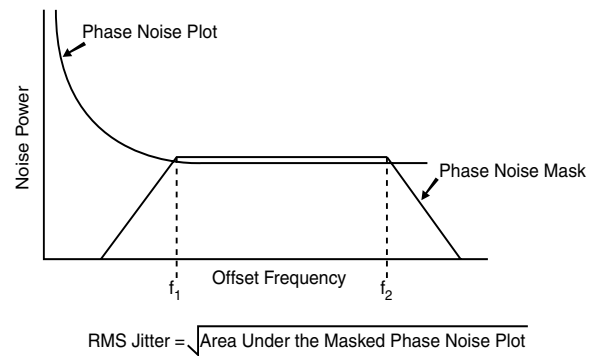

RMS PHASE JITTER

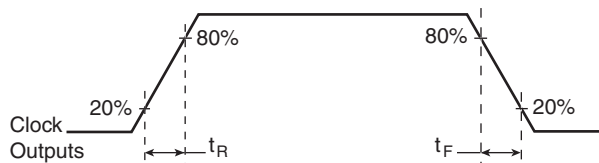

OUTPUT RISE/FALL TIME



APPLICATION INFORMATION

POWER SUPPLY FILTERING TECHNIQUES

As in any high speed analog circuitry, the power supply pins are vulnerable to random noise. The ICS840051I provides separate power supplies to isolate any high switching noise from the outputs to the internal PLL. V_{DD} and V_{DDA} should be individually connected to the power supply plane through vias, and bypass capacitors should be used for each pin. To achieve optimum jitter performance, power supply isolation is required. *Figure 1* illustrates how a 10Ω resistor along with a $10\mu\text{F}$ and a $.01\mu\text{F}$ bypass capacitor should be connected to each V_{DDA} pin.

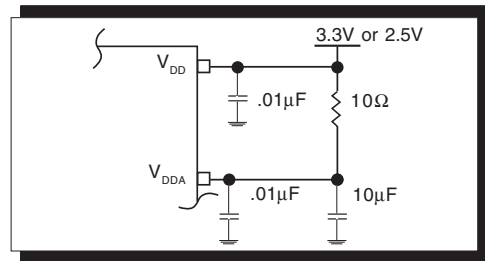

FIGURE 1. POWER SUPPLY FILTERING

CRYSTAL INPUT INTERFACE

The ICS840051I has been characterized with 18pF parallel resonant crystals. The capacitor values, C1 and C2, shown in *Figure 2* below were determined using a 26.04167MHz, 18pF

parallel resonant crystal and were chosen to minimize the ppm error. The optimum C1 and C2 values can be slightly adjusted for different board layouts.

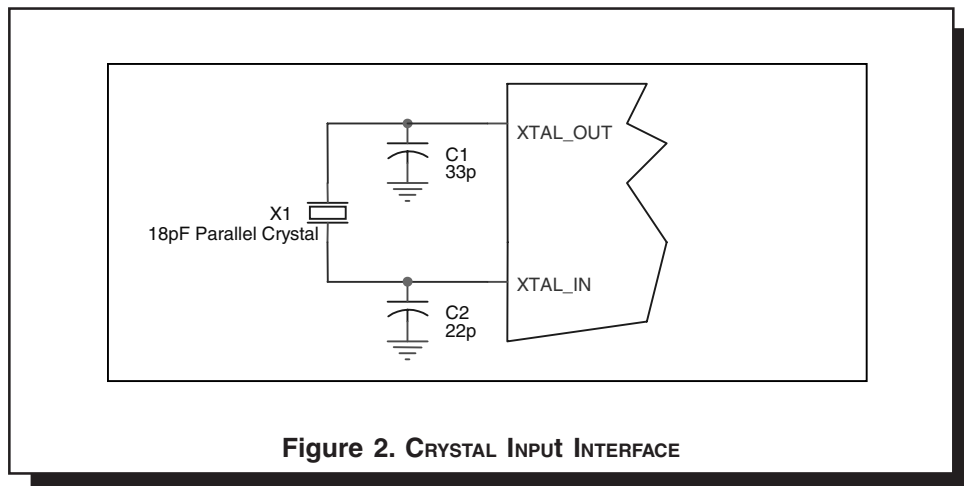

Figure 2. CRYSTAL INPUT INTERFACE



RELIABILITY INFORMATION

TABLE 7. θ_{JA} vs. AIR FLOW TABLE FOR 8 LEAD TSSOP

θ_{JA} by Velocity (Meters per Second)			
	0	1	2.5
Multi-Layer PCB, JEDEC Standard Test Boards	101.7°C/W	90.5°C/W	89.8°C/W

TRANSISTOR COUNT

The transistor count for ICS840051I is: 1927



PACKAGE OUTLINE - G SUFFIX FOR 8 LEAD TSSOP

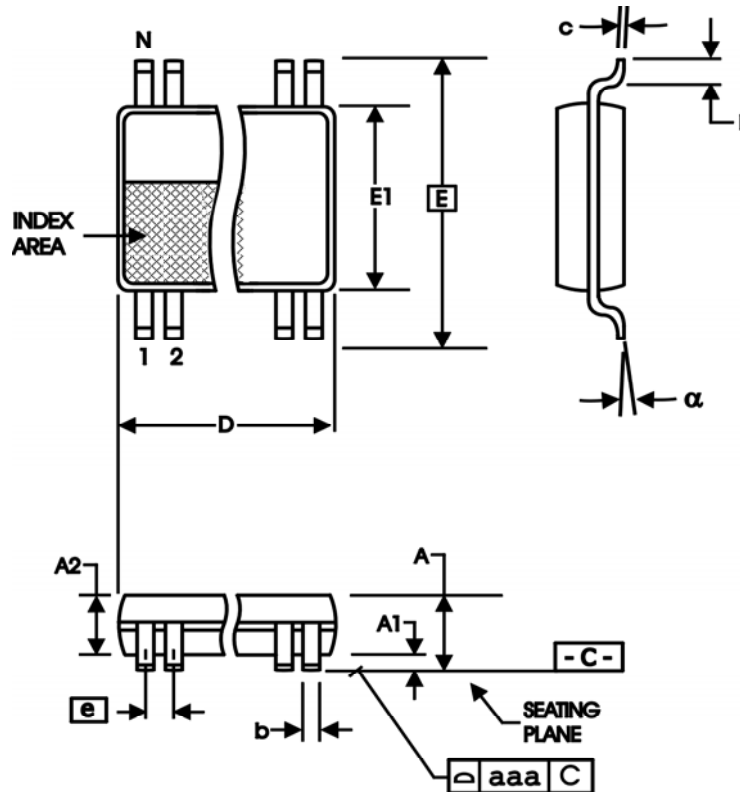

TABLE 8. PACKAGE DIMENSIONS

SYMBOL	Millimeters	
	Minimum	Maximum
N	8	
A	--	1.20
A1	0.05	0.15
A2	0.80	1.05
b	0.19	0.30
c	0.09	0.20
D	2.90	3.10
E	6.40 BASIC	
E1	4.30	4.50
e	0.65 BASIC	
L	0.45	0.75
α	0°	8°
aaa	--	0.10

Reference Document: JEDEC Publication 95, MO-153



Integrated
Circuit
Systems, Inc.

ICS840051I

FEMTOCLOCKS™ CRYSTAL-TO- LVCMOS/LVTTL CLOCK GENERATOR

TABLE 9. ORDERING INFORMATION

Part/Order Number	Marking	Package	Shipping Packaging	Temperature
ICS840051AGI	051AI	8 Lead TSSOP	tube	-40°C to 85°C
ICS840051AGIT	051AI	8 Lead TSSOP	2500 tape & reel	-40°C to 85°C
ICS840051AGILF	TBD	8 Lead "Lead-Free" TSSOP	tube	-40°C to 85°C
ICS840051AGILFT	TBD	8 Lead "Lead-Free" TSSOP	2500 tape & reel	-40°C to 85°C

The aforementioned trademarks, HiPerClockS™ and FemtoClocks™ are a trademark of Integrated Circuit Systems, Inc. or its subsidiaries in the United States and/or other countries. While the information presented herein has been checked for both accuracy and reliability, Integrated Circuit Systems, Incorporated (ICS) assumes no responsibility for either its use or for infringement of any patents or other rights of third parties, which would result from its use. No other circuits, patents, or licenses are implied. This product is intended for use in normal commercial and industrial applications. Any other applications such as those requiring high reliability or other extraordinary environmental requirements are not recommended without additional processing by ICS. ICS reserves the right to change any circuitry or specifications without notice. ICS does not authorize or warrant any ICS product for use in life support devices or critical medical instruments.