

Agilent HPMD-7905 FBAR Duplexer for US PCS Band

Data Sheet

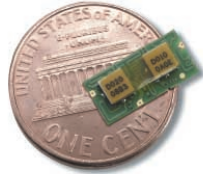

General Description

The HPMD-7905 is a miniaturized duplexer designed for US PCS handset, designed using Agilent Technologies' Film Bulk Acoustic Resonator (FBAR) Technology. The HPMD-7905 features a very small size: it is less than 2 mm thick and has a footprint of only 5.6 x 11.9 mm².

The HPMD-7905 enhances the sensitivity and dynamic range of CDMA receivers, providing more than 49 dB attenuation of transmitted signal at the receiver input, and more than 37 dB rejection of the transmit-generated noise in the receive band. Typical insertion loss in the Tx channel is only 2.5 dB, minimizing current drain from the power amplifier. Typical insertion loss in the Rx channel is 3.0 dB, improving receiver sensitivity.

Agilent's thin-Film Bulk Acoustic Resonator (FBAR) technology makes possible high-Q filters at a fraction their usual size. The excellent power handling of the bulk-mode resonators supports the high output powers needed in PCS handsets, with virtually no added distortion.

Board Diagram

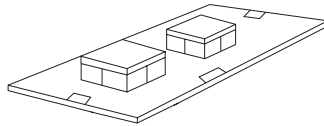

Functional Block Diagram

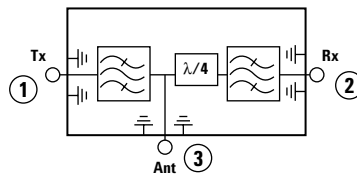

port numbers are circled

Features

- **Miniature size:** less than 2 mm high; 5.6 x 11.9 footprint
- **Rx Band:** 1930-1990 MHz
Typical performance:
Rx noise blocking: 42dB
Insertion loss: 3.0 dB
- **Tx Band:** 1850-1910 MHz
Typical performance:
Tx interferer blocking: 54dB
Insertion Loss: 2.5 dB
- **30 dBm Tx power handling**

Applications

- **Handsets or data terminals operating in the US PCS frequency band**



HPMD-7905 Electrical Specifications, $Z_0 = 50\Omega$, $T_c^{[1]}$ as indicated

Symbol	Parameters	Units	$+25^\circ\text{C}^{[1,3]}$			$+85^\circ\text{C}^{[1,2,3]}$		$-30^\circ\text{C}^{[1,2,3]}$	
			Min	Typ	Max	Min	Max	Min	Max
f_{RX}	Receive Bandwidth	MHz	1930.6	—	1989.4	1930.6	1989.4	1930.6	1989.4
S23 Rx	Attenuation in Transmit Band (1850.6–1853 MHz)	dB	48	—	—	47	—	45	—
S23 Rx	Attenuation in Transmit Band (1853–1909.4 MHz)	dB	50	54	—	47	—	47	—
S23 Rx	Insertion Loss in Receive Band (1930.6–1935 MHz)	dB	—	—	3.5	—	3.5	—	4.5
S23 Rx	Insertion Loss in Receive Band (1935–1987 MHz)	dB	—	3.0	3.5	—	3.8	—	3.8
S23 Rx	Insertion Loss in Receive Band (1987–1989.4 MHz)	dB	—	—	3.5	—	3.8	—	3.5
Δ S23	Ripple in Receive Band	dB	—	1.5	—	—	—	—	—
S22 Rx	Return Loss in Receive Band	dB	8.0	—	—	8.0	—	8.0	—
f_{TX}	Transmit Bandwidth	MHz	1850.6	—	1909.4	1850.6	1909.4	1850.6	1909.4
S31 Tx	Attenuation in Receive Band (1930.6–1931 MHz)	dB	39	—	—	37.5	—	32.5	—
S31 Tx	Attenuation in Receive Band (1931–1934 MHz)	dB	39	—	—	37.5	—	35	—
S31 Tx	Attenuation in Receive Band (1934–1987 MHz)	dB	39	42	—	37.5	—	37.5	—
S31 Tx	Attenuation in Receive Band (1987–1989.4 MHz)	dB	37.5	—	—	35	—	37.5	—
S31 Tx	Insertion Loss in Transmit Band (1850.6–1853 MHz)	dB	—	2.5	3.0	—	3.8	—	3.8
S31 Tx	Insertion Loss in Transmit Band (1853–1907 MHz)	dB	—	2.5	3.0	—	3.5	—	3.5
S31 Tx	Insertion Loss in Transmit Band (1907–1909.4 MHz)	dB	—	—	3.0	—	3.8	—	3.0
Δ S31	Ripple in Transmit Band	dB	—	2.0	—	—	—	—	—
S11 Tx	Return Loss in Transmit Band	dB	8.0	—	—	8.0	—	8.0	—
IP3	Third Order Intercept Point	dBm	—	>60	—	—	—	—	—
S21	Tx-Rx Isolation (1850.6–1860 MHz)	dB	49	—	—	47	—	47	—
S21	Tx-Rx Isolation (1860–1907 MHz)	dB	50	54	—	48	—	47	—
S21	Tx-Rx Isolation (1907–1909.4 MHz)	dB	50	54	—	45	—	48	—
S21	Tx-Rx Isolation (1930.6–1934 MHz)	dB	39	42	—	38	—	35	—
S21	Tx-Rx Isolation (1934–1972 MHz)	dB	39	42	—	38	—	38	—
S21	Tx-Rx Isolation (1972–1975 MHz)	dB	39	42	—	37	—	38	—
S21	Tx-Rx Isolation (1975–1989.4 MHz)	dB	37	—	—	35	—	37	—

Absolute Maximum Ratings^[4]

Parameter	Unit	Value
Operating temperature ^[1]	$^\circ\text{C}$	-30 to +85
Storage temperature ^[1]	$^\circ\text{C}$	-30 to +100

Notes:

- T_c is defined as case temperature, the temperature of the underside of the duplexer where it makes contact with the circuit board.
- Specifications are given at operating temperature limits and room temperature. To estimate performance at some intermediate temperature, use linear interpolation.
- Specifications are guaranteed over the given temperature range, with the input power to the Tx port equal to +30 dBm (or lower) over all Tx frequencies. The application of input power levels in excess of +30 dBm will not destroy the duplexer, but its performance may exceed the specification limits given above.
- Operation in excess of any one of these conditions may result in permanent damage to the device.

The plots below provide typical performance obtained from samples of the HPMD-7905 duplexer.

In order to obtain the best performance from the HPMD-7905 duplexer, refer to Design Note D007, which is

available from your Agilent Technologies technical support or sales departments.

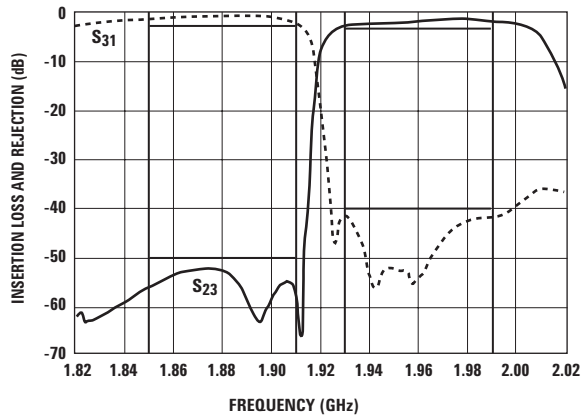

Figure 1. Tx and Rx Port Insertion Loss (typical).

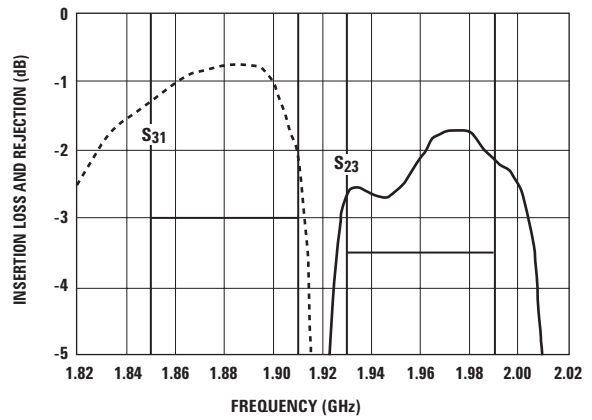

Figure 2. Insertion Loss Detail (typical).

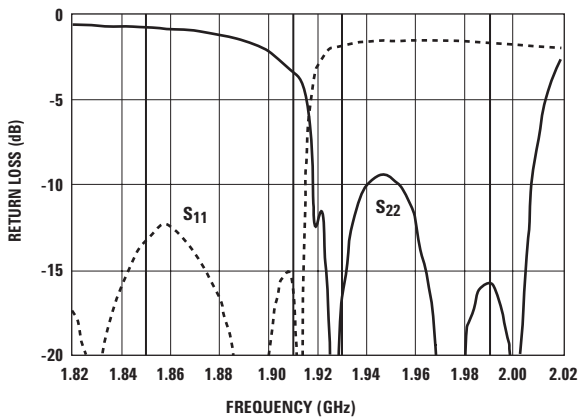

Figure 3. Tx and Rx Port Return Loss (typical).

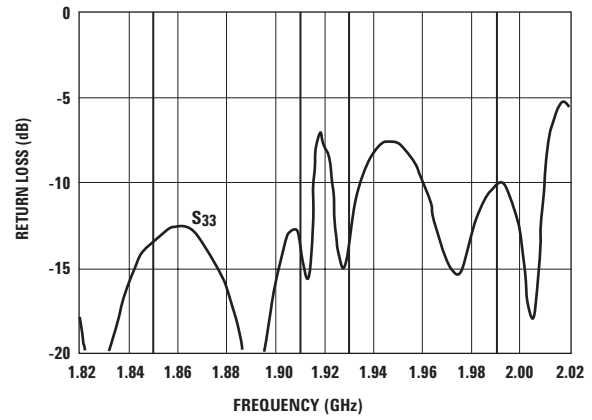
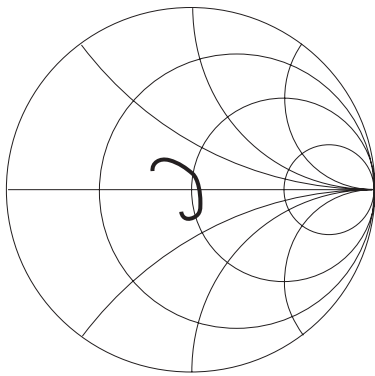
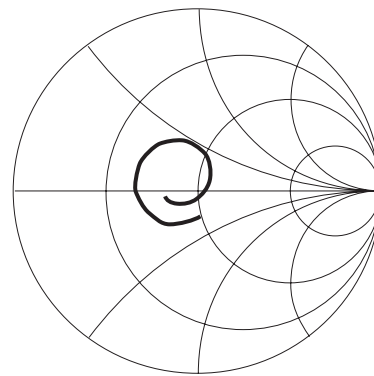

Figure 4. Ant Port Return Loss (typical).



freq (1.850 GHz to 1.910 GHz)

Figure 5. S11, Tx Port Impedance (typical).



freq (1.930 GHz to 1.990 GHz)

Figure 6. S22, Rx Port Impedance (typical).

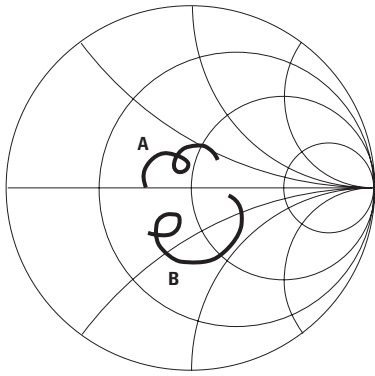

A: freq (1.850 GHz to 1.910 GHz)
 B: freq (1.930 GHz to 1.990 GHz)

Figure 7. S33, Ant Port Impedance.

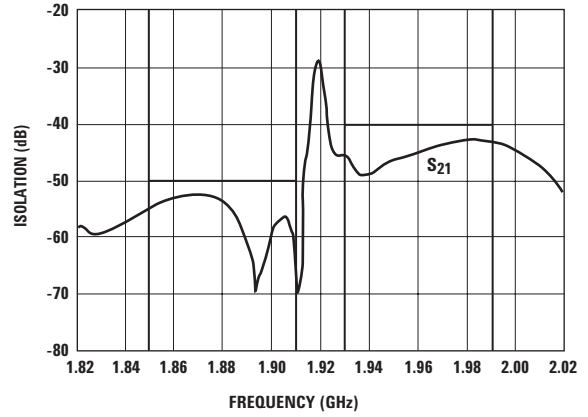

Figure 8. S₂₁, Isolation (typical).

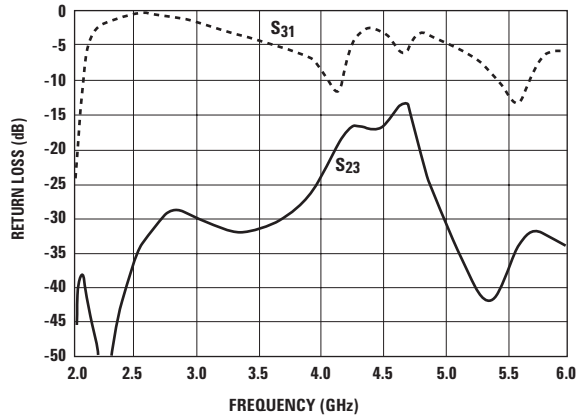

Figure 9. Wideband Insertion Loss (typical).

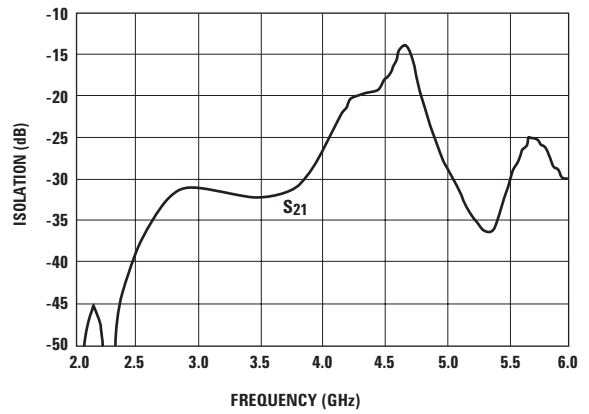

Figure 10. Wideband Isolation (typical).

Note that the specifications given on page 2 are guaranteed when the duplexer is mounted on a ground surface with a hole pattern like that one shown in Figure 11. See Design Note D007,

which is available from your Agilent Technologies technical support or sales departments.

Note that it is important that proper heat sinking be provided

in order to remove the heat generated in the Tx filter by the handset's power amplifier. Failure to do so may result in excessive losses, especially at the top end of the Tx band.

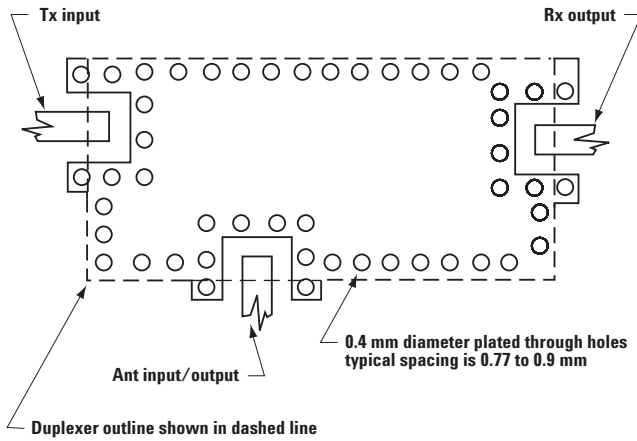

Figure 11. Mounting (grounding) Pattern.

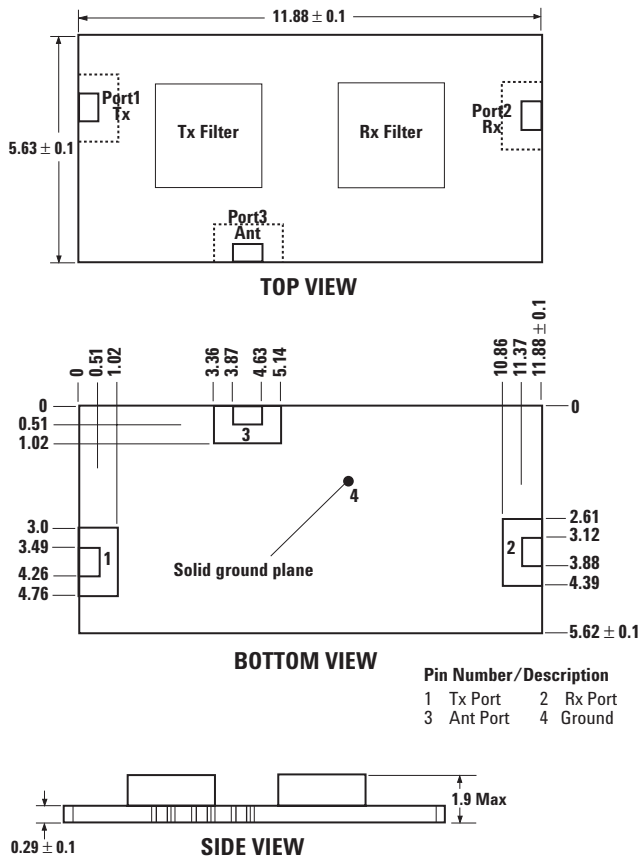
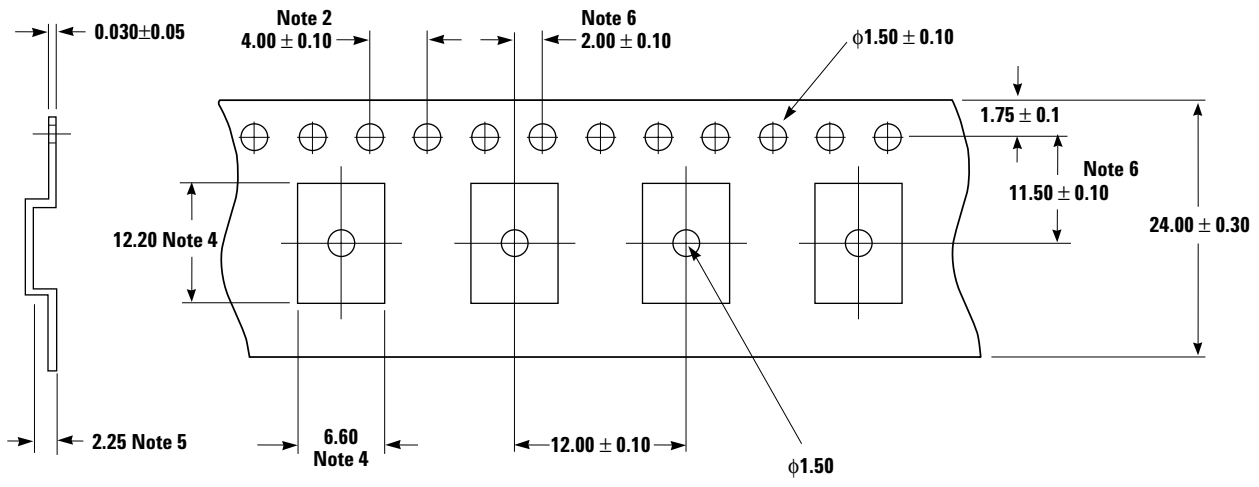

Figure 12. Outline Drawing.

Note:
All dimensions in millimeters.



- Notes:**
1. All dimensions in mm.
 2. 10 sprocket hole pitch accumulative tolerance ± 0.10 mm
 3. Camber not exceed 1 mm in 250 mm
 4. Pocket dimensions measured on a plane 0.3 mm above the bottom of the pocket.
 5. Pocket depth measured from a plane on the inside bottom of the pocket to the top surface of the carrier.
 6. Pocket position on relative to sprocket hole measure as true position of pocket, not the pocket hole.

Figure 13. Tape Drawing.

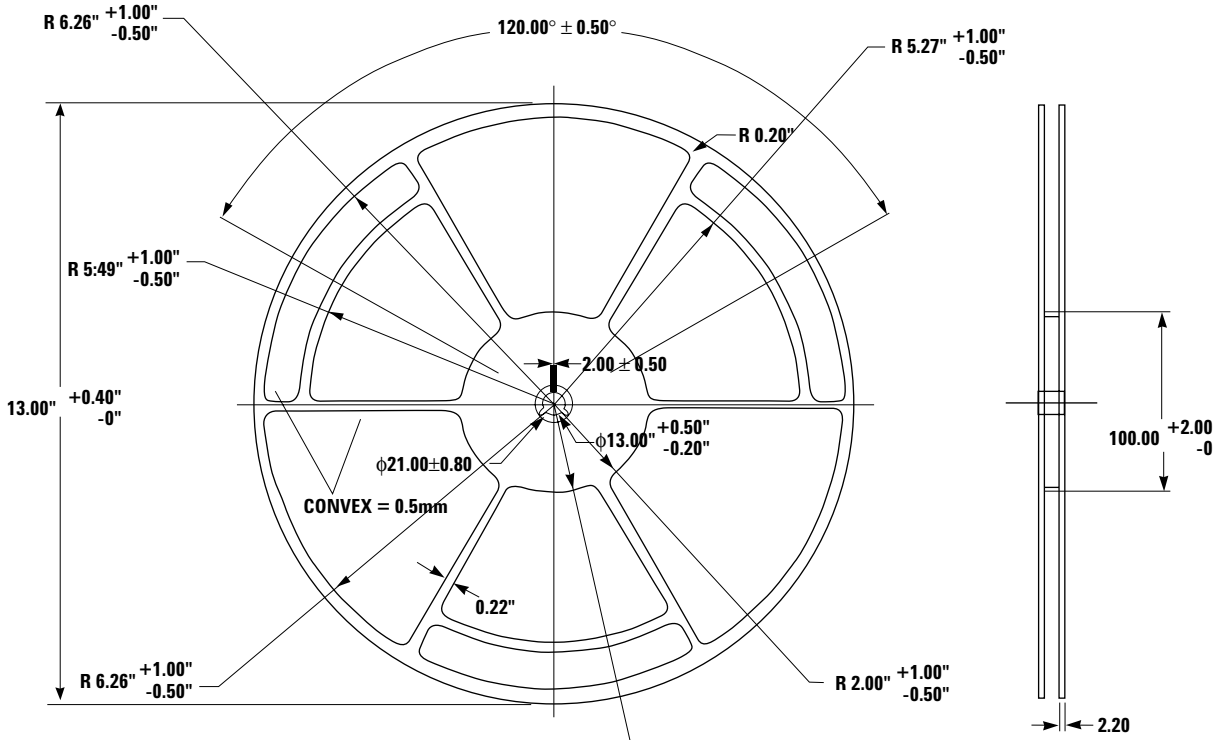

- Notes:**
1. All dimensions in mm, unless otherwise noted.
 2. Material: polystyrene
 3. Surface resistivity: 1×10^9 ohm-mm²

Figure 14. Reel Drawing.

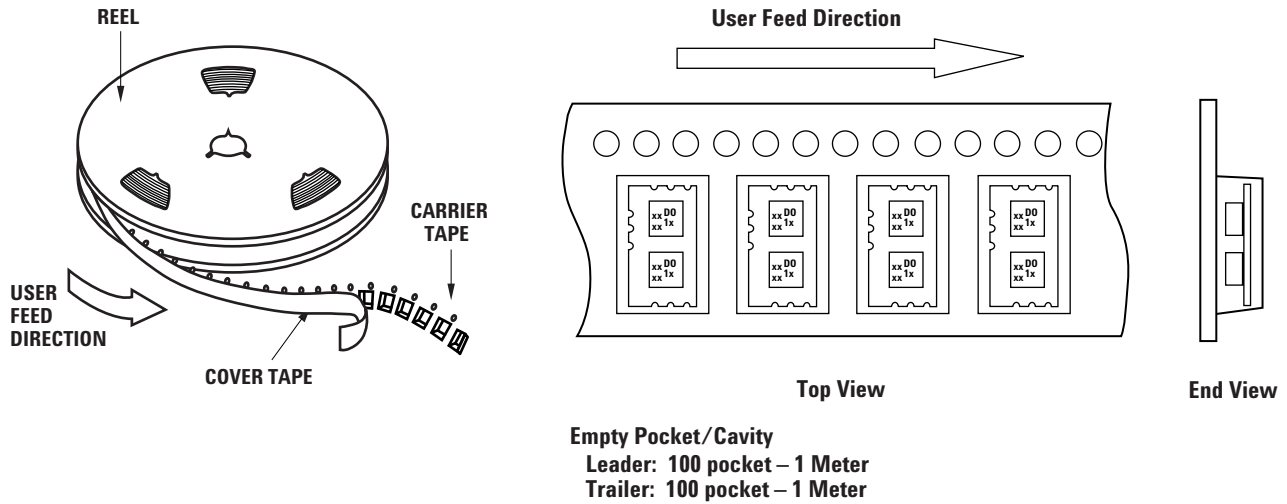

Figure 15. Device Orientation.

Solder Recommendations

The HPMD-7905 FBAR duplexer (and its variants) is an assembly consisting of two LCC ceramic packages, containing the Tx and Rx filters, mounted to a small circuit board. Both packages on the circuit board are mounted in place using Sn96.5/Ag3.5 solder (shaded in Table 1).

The recommended solder profile for the FBAR duplexer is shown in Figure 16. Guidelines and a typical profile are both shown. This typical profile was tested on ten samples of the duplexer, each of which was subjected to the profile six times without effect upon the mechanical or electrical characteristics of the device.

Solder temperatures and times in excess of those given in the guidelines of Table 1 may result in damage to the duplexer or changes in its characteristics.

Table 1. Solder Compositions

Alloy type	Melting temp. (°C)	Recommended working temperature (°C)	Comments
Sn42Bi58	138	160 – 180	Lead free
Sn43Pb43Bi14	144 – 163	165 – 185	Contains lead – some customers prohibit it.
Sn63Pb37	183	200 – 240	Contains lead – some customers prohibit it.
Sn60Pb40	186	200 – 240	Contains lead – some customers prohibit it.
Sn91/Zn9	199	200 – 240	May have oxidation problems
Sn96.2Ag2.5Cu0.8Sb0.5	216	235 – 255	Popular lead free composition
Sn95.8Ag3.5Cu0.7	217	235 – 255	Other alloy ratios are available
Sn96.5Ag3.5	221	240 – 260	Used in the assembly of duplexers
Sn100	232	260 – 280	Too hot – will melt the duplexer
Sn95Sb5	235	260 – 280	Too hot – will melt the duplexer
Sn97Cu3	240	260 – 300	Too hot – will melt the duplexer

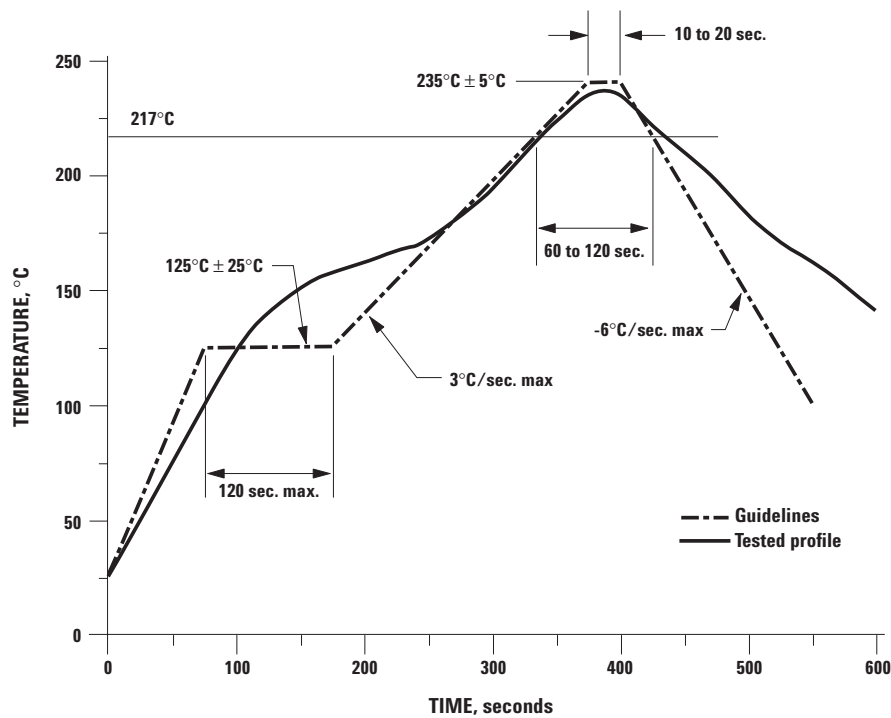

Figure 16. Recommended Solder Profile.

Part Number Ordering Information

Part Number	No. of Devices	Container
HPMD-7905-BLK	25	antistatic bag
HPMD-7905-TR1	1000	13" reel

www.agilent.com/semiconductors

For product information and a complete list of distributors, please go to our web site.

For technical assistance call:

Americas/Canada: +1 (800) 235-0312 or (408) 654-8675

Europe: +49 (0) 6441 92460

China: 10800 650 0017

Hong Kong: (+65) 6271 2451

India, Australia, New Zealand: (+65) 6271 2394

Japan: (+81 3) 3335-8152(Domestic/International), or 0120-61-1280(Domestic Only)

Korea: (+65) 6271 2194

Malaysia, Singapore: (+65) 6271 2054

Taiwan: (+65) 6271 2654

Data subject to change.

Copyright © 2002 Agilent Technologies, Inc.

Obsoletes 5988-6611EN

August 1, 2002

5988-7470EN



Agilent Technologies