

HOA1882

Transmissive Sensor

FEATURES

- Choice of phototransistor or photodarlington output
- Compact package size
- Dust protective housing
- 0.060 in.(1.52 mm)dia. detector aperture
- 0.200 in.(5.08 mm) slot width

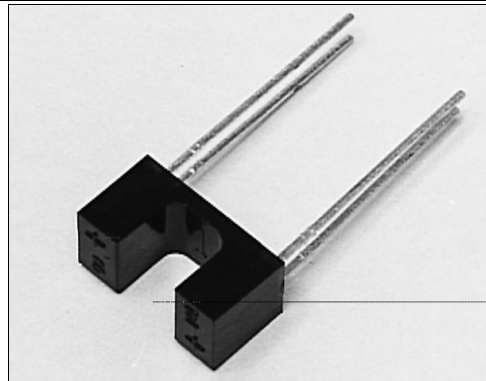

INFRA-25.TIF

DESCRIPTION

The HOA1882 series consists of an infrared emitting diode facing an NPN silicon phototransistor (HOA1882- 011, - 012) or photodarlington (HOA1882- 013) encased in a black IR transmissive thermoplastic housing. Detector switching takes place whenever an opaque object passes through the slot between emitter and detector. The HOA1882 series employs an IR transmissive housing which features smooth optical faces without external aperture openings; this feature is desirable when aperture blockage from airborne contaminants is a possibility.

The HOA1882 series employs plastic molded components. For additional component information see SEP8506/8706, SDP8406, and SDP8106.

Housing material is IR transmissive polysulfone. Housings are soluble in chlorinated hydrocarbons and ketones. Recommended cleaning agents are methanol and isopropanol.

OUTLINE DIMENSIONS in inches (mm)

Tolerance 3 plc decimals $\pm 0.010(0.25)$
 2 plc decimals $\pm 0.020(0.51)$

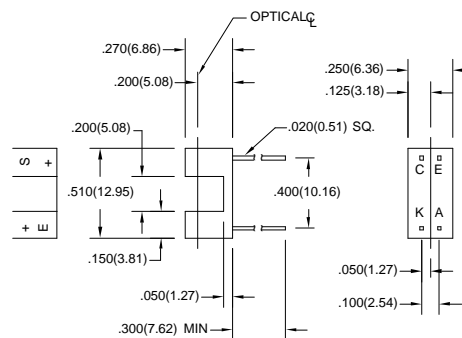

DIM_053.cdr

HOA1882

Transmissive Sensor

ELECTRICAL CHARACTERISTICS (25°C unless otherwise noted)

PARAMETER	SYMBOL	MIN	TYP	MAX	UNITS	TEST CONDITIONS
IR EMITTER						
Forward Voltage	V_F			1.6	V	$I_F=20\text{ mA}$
Reverse Leakage Current	I_R			10	μA	$V_R=3\text{ V}$
DETECTOR						
Collector-Emitter Breakdown Voltage HOA1882-011, -012 HOA1882-013	$V_{(BR)CEO}$	30 15			V	$I_C=100\ \mu\text{A}$
Emitter-Collector Breakdown Voltage	$V_{(BR)ECO}$	5.0			V	$I_E=100\ \mu\text{A}$
Collector Dark Current HOA1882-011, -012 HOA1882-013	I_{CEO}			100 250	nA	$V_{CE}=10\text{ V}$ $I_F=0$
COUPLED CHARACTERISTICS						
On-State Collector Current HOA1882-011 HOA1882-012 HOA1882-013	$I_{C(ON)}$	0.3 1.8 4.0			mA	$V_{CE}=5\text{ V}$ $I_F=20\text{ mA}$
Collector-Emitter Saturation Voltage HOA1882-011 HOA1882-012 HOA1882-013	$V_{CE(SAT)}$			0.4 0.4 1.1	V	$I_F=20\text{ mA}$ $I_C=40\ \mu\text{A}$ $I_C=230\ \mu\text{A}$ $I_C=500\ \mu\text{A}$
Rise And Fall Time HOA1882-011, -012 HOA1882-013	t_r, t_f			15 75	μs	$V_{CC}=5\text{ V}, I_C=1\text{ mA}$ $R_L=1000\ \Omega$ $R_L=100\ \Omega$

ABSOLUTE MAXIMUM RATINGS

(25°C Free-Air Temperature unless otherwise noted)

Operating Temperature Range -40°C to 85°C

Storage Temperature Range -40°C to 85°C

Soldering Temperature (5 sec) 240°C

IR EMITTER

Power Dissipation 100 mW ⁽¹⁾

Reverse Voltage 3 V

Continuous Forward Current 50 mA

DETECTOR

Collector-Emitter Voltage 30 V

Emitter-Collector Voltage 5 V

Power Dissipation 100 mW ⁽¹⁾

Notes

1. Derate linearly at 0.78 mW/°C above 25°C.

SCHEMATIC

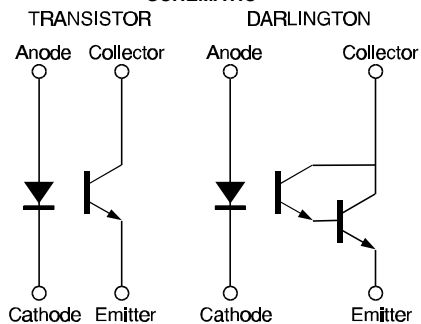

Honeywell reserves the right to make changes in order to improve design and supply the best products possible.

Honeywell

HOA1882

Transmissive Sensor

Fig. 1 IRED Forward Bias Characteristics

gra_092.ds4

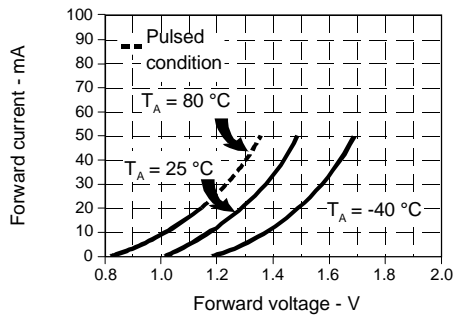

Fig. 2 Non-Saturated Switching Time vs Load Resistance

gra_096.ds4

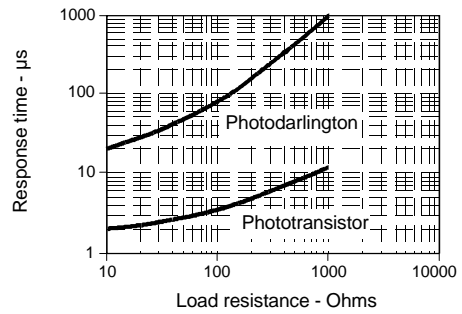

Fig. 3 Dark Current vs Temperature

gra_301.cdr

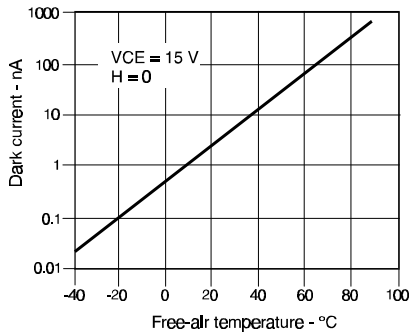
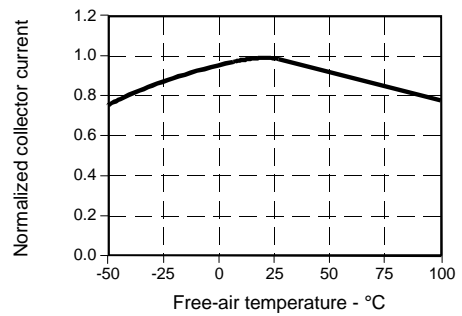

Fig. 4 Collector Current vs Ambient Temperature

gra_095.ds4



All Performance Curves Show Typical Values

HOA1882
Transmissive Sensor

Honeywell reserves the right to make changes in order to improve design and supply the best products possible.

Honeywell

321