



### Typical Applications

The HMC-C044 is ideal for:

- Point-to-Point Radios
- Point-to-Multi-Point Radios & VSAT
- Test Equipment & Sensors
- Military End-Use

### Functional Diagram

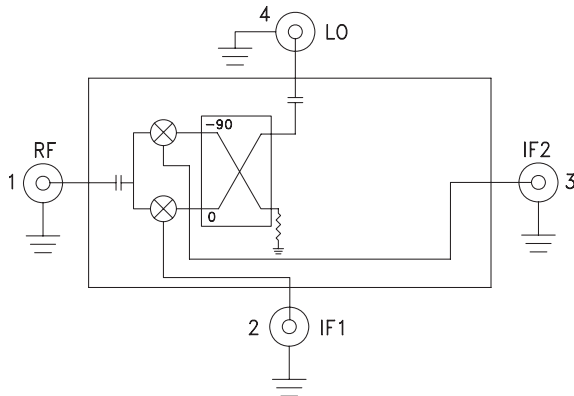

### Features

- Wide IF Bandwidth: DC - 3.5 GHz
- Image Rejection: 30 dB
- LO to RF Isolation: 35 dB
- High Input IP3: +25 dBm
- Hermetically Sealed Module
- Field Replaceable SMA Connectors
- 55 to +85 °C Operating Temperature

### General Description

The HMC-C044 is a passive I/Q MMIC mixer housed in a miniature hermetic module which can be used as either an Image Reject Mixer or a Single Sideband Upconverter. The module utilizes two standard Hittite double balanced mixer cells and a 90 degree hybrid fabricated on a GaAs MESFET process. A low frequency quadrature hybrid was used to produce a 100 MHz USB IF output. This MMIC based module is a more reliable and consistent alternative to hybrid style I/Q Mixers and Single Sideband Converter assemblies. The module features removable SMA connectors which can be detached to allow direct connection of the I/O pins to a microstrip or coplanar circuit.

### Electrical Specifications, $T_A = +25^\circ \text{C}$ , $IF = 100 \text{ MHz}$ , $LO = +17 \text{ dBm}^*$

Parameter	Min.	Typ.	Max.	Units
Frequency Range, RF/LO	15 - 23			GHz
Frequency Range, IF	DC - 3.5			GHz
Conversion Loss (As IRM)		8	10	dB
Image Rejection	18	30		dB
1 dB Compression (Input)		+15		dBm
LO to RF Isolation	30	35		dB
LO to IF Isolation	17	22		dB
IP3 (Input)		+25		dBm
Amplitude Balance		0.3		dB
Phase Balance		4		Deg

\* Unless otherwise noted, all measurements performed as downconverter.



Data taken As IRM With External IF Hybrid

**Conversion Gain vs. Temperature**

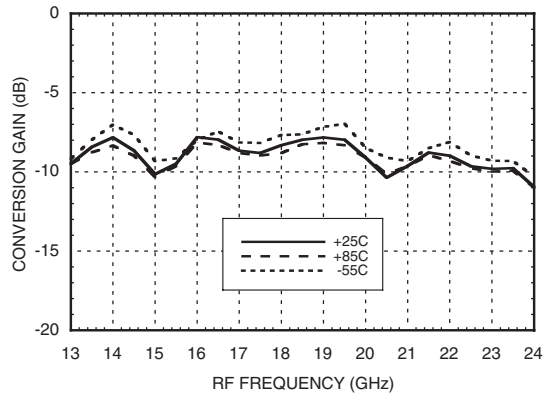

**Image Rejection vs. Temperature**

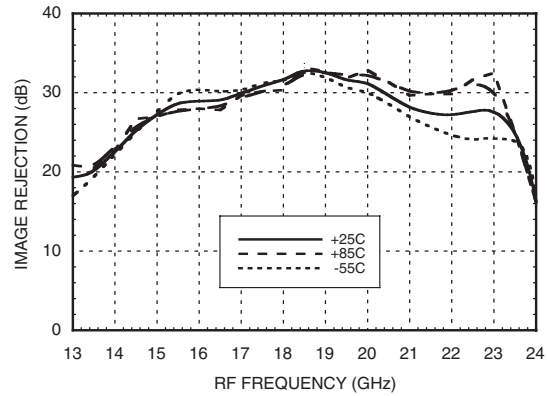

**Conversion Gain vs. LO Drive**

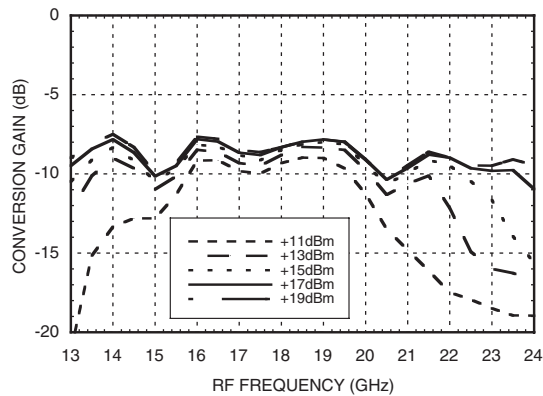

**Return Loss**

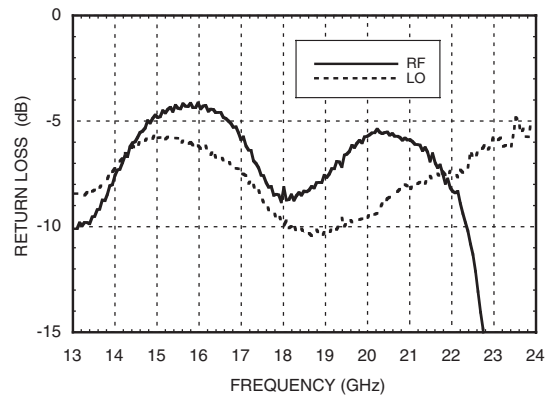

**Input P1dB vs. Temperature**

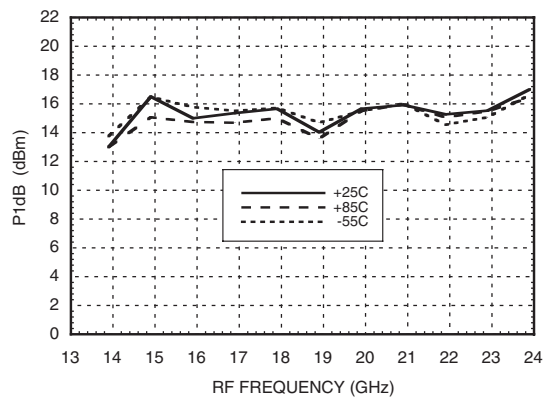

**Input IP3 vs. LO Drive**

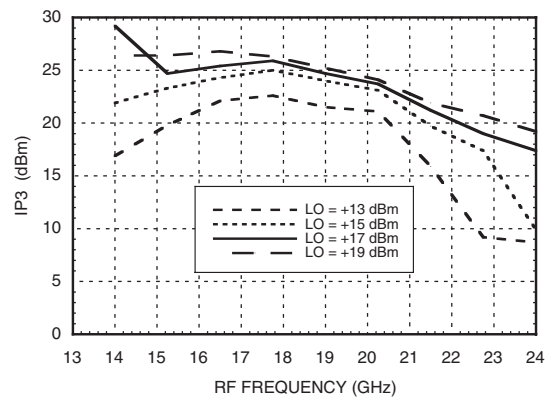



### Quadrature Channel Data Taken Without IF Hybrid

#### Isolations

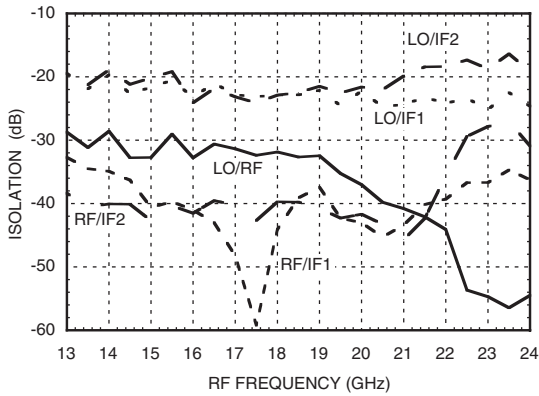

#### IF Bandwidth\*

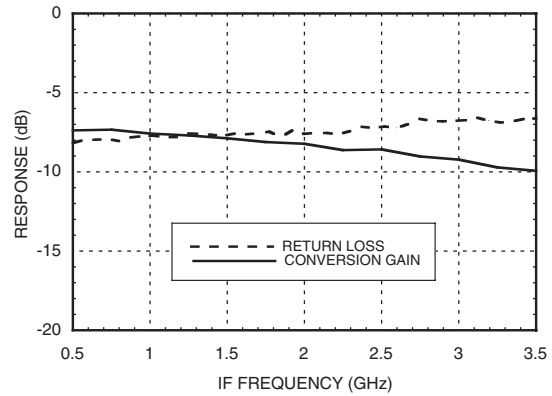

#### Amplitude Balance vs. LO Drive

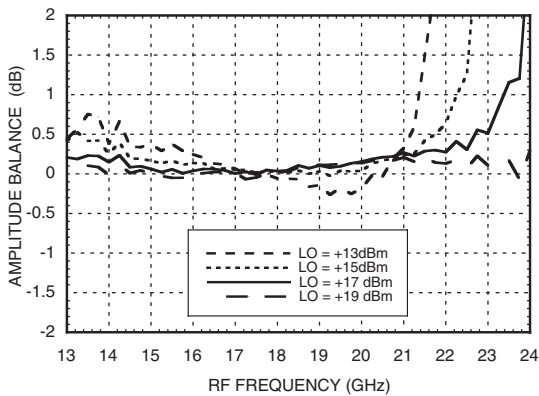

#### Phase Balance vs. LO Drive

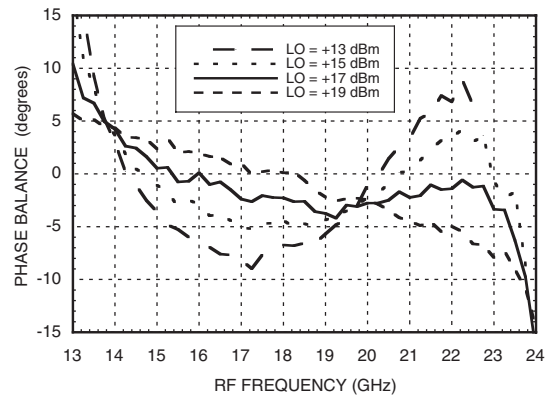

#### Upconverter Performance Conversion Gain vs. LO Drive\*

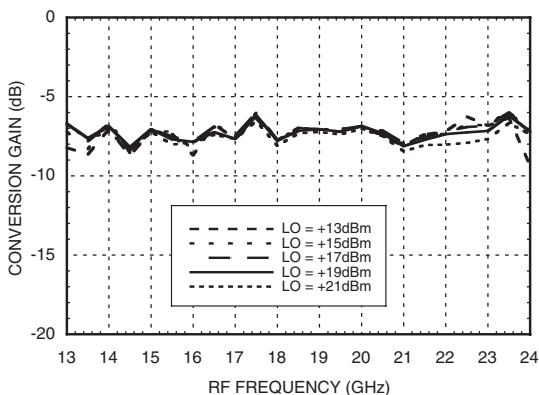

#### Upconverter Performance Sideband Rejection vs. LO Drive\*

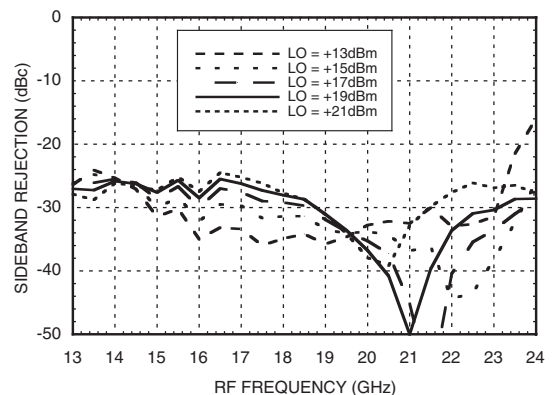

\* Conversion gain data taken with external IF hybrid

**Harmonics of LO**

LO Freq. (GHz)	nLO Spur at RF Port	
	1	2
15.5	31	51
17	31	56
18.5	32	63
20	37	73
21.5	42	72
23	55	71

LO = + 15 dBm  
Values in dBc below input LO level measured at RF Port.

**MxN Spurious Outputs**

mRF	nLO				
	0	1	2	3	4
0	xx	-9	29	xx	xx
1	34	0	46	61	xx
2	87	65	82	62	87
3	xx	87	92	86	90
4	xx	xx	84	92	92

RF = 17.6 GHz @ -10 dBm  
LO = 17.5 GHz @ +15 dBm  
Data taken without IF hybrid  
All values in dBc below IF power level

**Absolute Maximum Ratings**

RF / IF Input	+20 dBm
LO Drive	+ 27 dBm
Channel Temperature	150°C
Continuous P <sub>diss</sub> (T=85°C) (derate 5.22 mW/°C above 85°C)	340 mW
Thermal Resistance (R <sub>TH</sub> ) (junction to package bottom)	191.5 °C/W
Storage Temperature	-65 to +150 °C
Operating Temperature	-55 to +85 deg °C



**ELECTROSTATIC SENSITIVE DEVICE  
OBSERVE HANDLING PRECAUTIONS**

### Outline Drawing

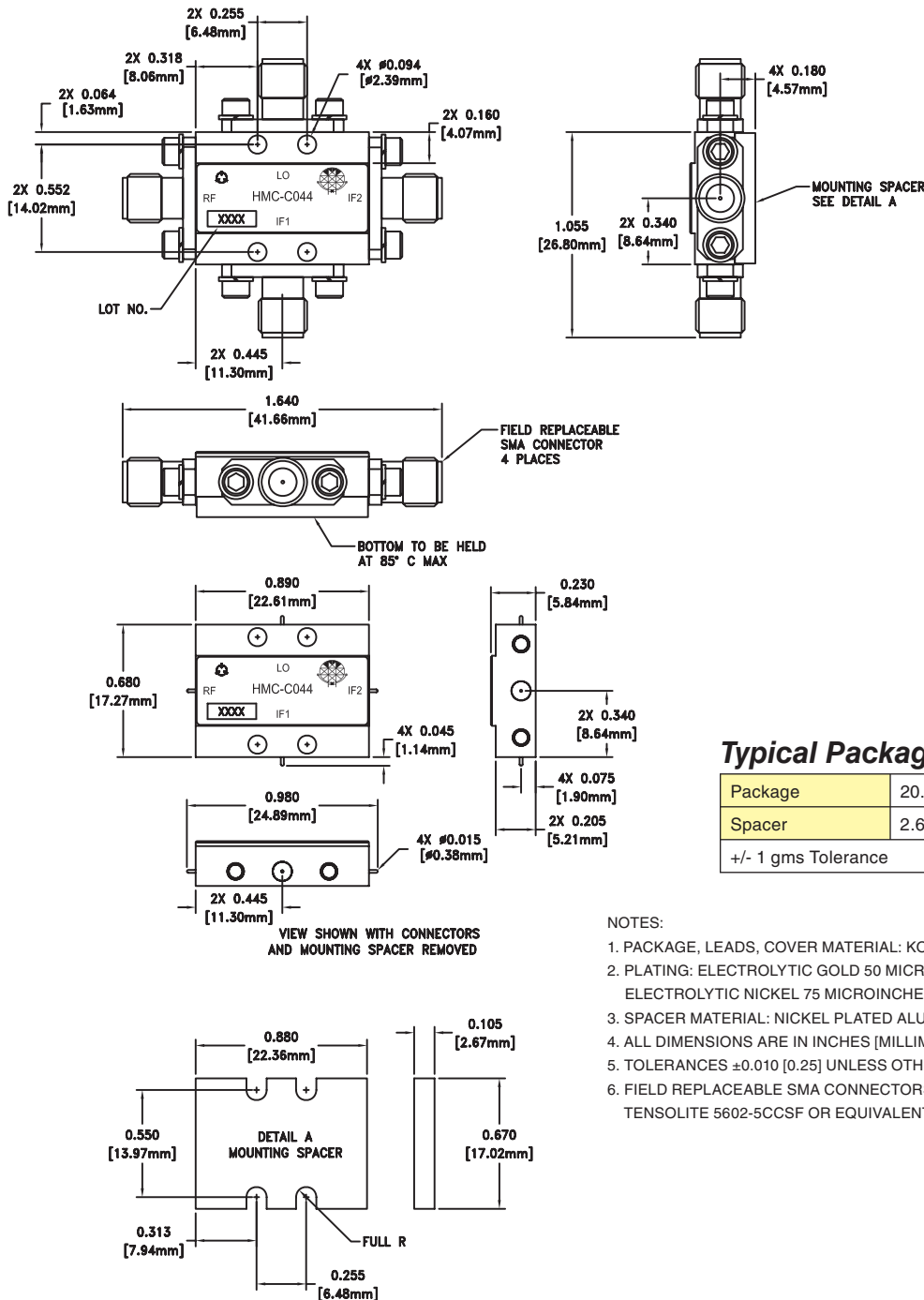

### Typical Package Weight

Package	20.0 gms
Spacer	2.6 gms
+/- 1 gms Tolerance	

#### NOTES:

1. PACKAGE, LEADS, COVER MATERIAL: KOVAR™
2. PLATING: ELECTROLYTIC GOLD 50 MICROINCHES MIN., OVER ELECTROLYTIC NICKEL 75 MICROINCHES MIN.
3. SPACER MATERIAL: NICKEL PLATED ALUMINUM
4. ALL DIMENSIONS ARE IN INCHES [MILLIMETERS].
5. TOLERANCES ±0.010 [0.25] UNLESS OTHERWISE SPECIFIED.
6. FIELD REPLACEABLE SMA CONNECTORS. TENSOLITE 5602-5CCSF OR EQUIVALENT.

**Pin Descriptions**

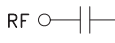
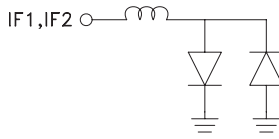
Pin Number	Function	Description	Interface Schematic
1	RF	This pin is AC coupled and matched to 50 Ohms from 15 to 23 GHz.	
2	IF1	This pin is DC coupled. For applications not requiring operation to DC, this port should be DC blocked externally using a series capacitor whose value has been chosen to pass the necessary IF frequency range. For operation to DC, this pin must not source/sink more than 3mA of current or part non-function and possible part failure will result.	
3	IF2		
4	LO	This pin is AC coupled and matched to 50 Ohms from 15 to 23 GHz.	