

PURE GREEN
PURE GREEN
SOFT ORANGE
SOFT ORANGE

HLMP-D600
HLMP-D640
HLMP-D400
HLMP-D401

TINTED
CLEAR
TINTED
TINTED

PACKAGE DIMENSIONS

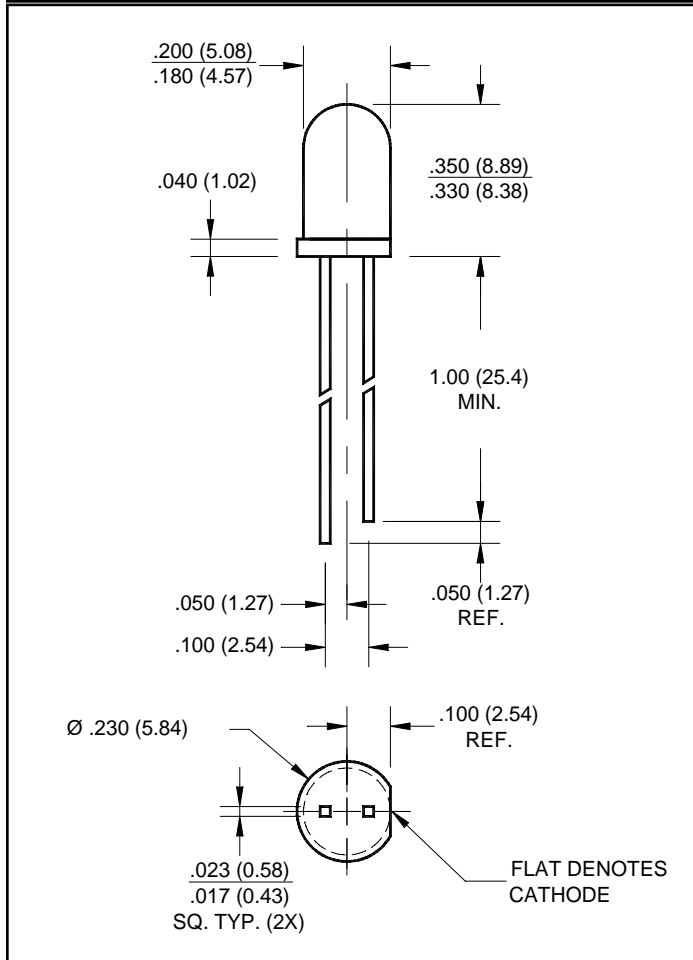

FEATURES

- Popular T-1 3/4 package
- Low drive current
- Solid state reliability
- Wide viewing angle
- Choice of pure green or soft orange colors

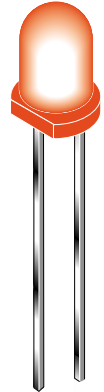

DESCRIPTION

These T-1 3/4 LEDs are widely used as general purpose indicators. The pure green lamps is made with a GaP LED on a GaP substrate. The soft orange is made with a GaAsP LED on a GaP substrate. They are encapsulated in epoxy packages and are designed to provide superior light output and a wide viewing angle.

NOTES:

1. ALL DIMENSIONS ARE IN INCHES (mm).
2. TOLERANCES ARE $\pm .010$ " INCH UNLESS SPECIFIED.
3. AN EPOXY MENISCUS MAY EXTEND ABOUT $.040$ " (1 mm) DOWN THE LEADS.

ABSOLUTE MAXIMUM RATING (T_A =25°C)

Parameter	GREEN	ORANGE	UNITS
Power Dissipation	110	110	mW
Forward Current	40	40	mA
Peak Forward Current (f=1kHz, DF=10%)	200	200	mA
Lead Soldering Time at 260° C	5	5	sec
Operating Temperature	-40 to +100	-40 to +100	°C
Storage Temperature	-40 to +100	-40 to +100	°C

ELECTRICAL / OPTICAL CHARACTERISTICS (T _A =25°C)					
Part Number	HLMP-D600	HLMP-D640*	HLMP-D400	HLMP-D401	Condition
Luminous Intensity (mcd)					I _F = 10mA
Minimum	1.0	6.7	2.1	4.0	
Typical	3.0	6.0	3.5	7.0	
Forward Voltage (V)					I _F = 10mA
Maximum	2.7	3.0	2.4	2.4	
Typical	2.1	2.2	1.9	1.9	
Peak Wavelength (nm)	555	555	612	612	I _F = 10mA
Spectral Line Half Width (nm)	24	24	40	40	I _F = 10mA
Reverse Voltage (V)	5	5	5	5	I _R = 100μA
Viewing Angle (°)	60	24	60	60	I _F = 10mA

* HLMP-D640 test condition is I_F = 20mA

TYPICAL PERFORMANCE CURVES ($T_A = 25^\circ\text{C}$)

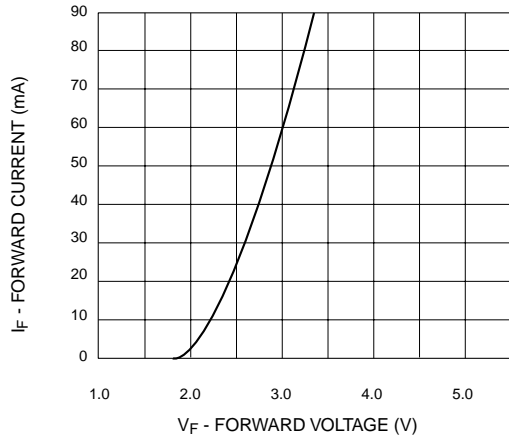

Fig. 1 Forward Current vs. Forward Voltage

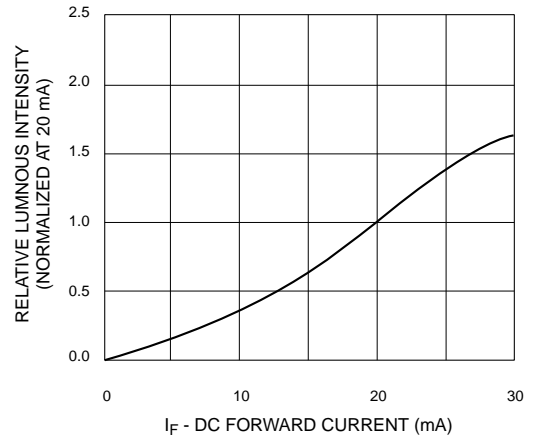

Fig. 2 Relative Luminous Intensity vs. DC Forward Current

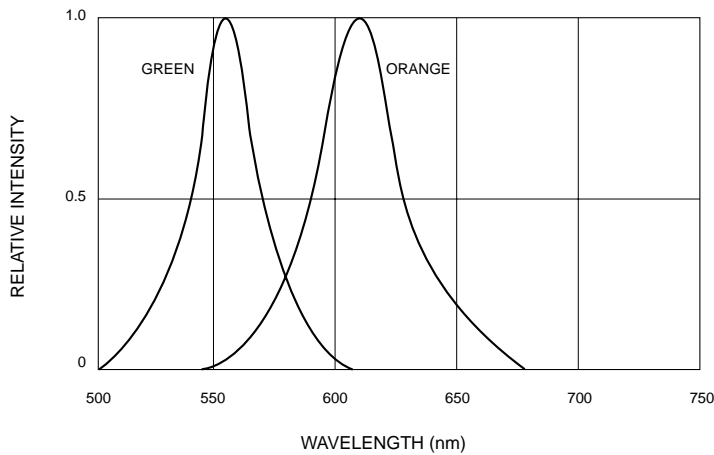

Fig. 3 Relative Intensity vs. Peak Wavelength

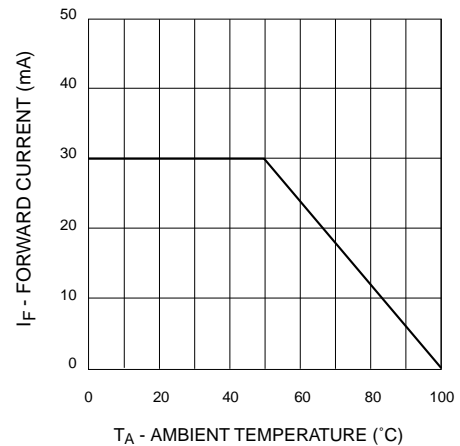
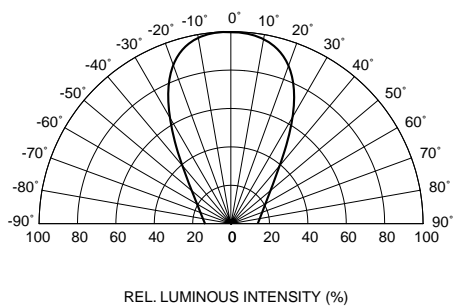
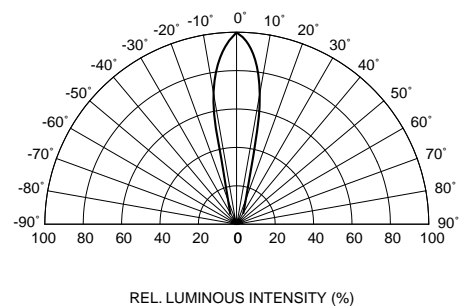

Fig. 4 Current Derating Curve



**Fig. 5A Radiation Diagram
(HLMP-D600, HLMP-D400, HLMP-D401)**



**Fig. 5B Radiation Diagram
(HLMP-D640)**

DISCLAIMER

FAIRCHILD SEMICONDUCTOR RESERVES THE THE RIGHT TO MAKE CHANGES WITHOUT FURTHER NOTICE TO ANY PRODUCTS HEREIN TO IMPROVE RELIABILITY, FUNCTION OR DESIGN. FAIRCHILD DOES NOT ASSUME ANY LIABILITY ARISING OUT OF THE APPLICATION OR USE OF ANY PRODUCT OR CIRCUIT DESCRIBED HEREIN; NEITHER DOES IT CONVEY ANY LICENSE UNDER ITS PATENT RIGHTS, NOR THE RIGHTS OF OTHERS.

LIFE SUPPORT POLICY

FAIRCHILD'S PRODUCTS ARE NOT AUTHORIZED FOR USE AS CRITICAL COMPONENTS IN LIFE SUPPORT DEVICES OR SYSTEMS WITHOUT THE EXPRESS WRITTEN APPROVAL OF THE PRESIDENT OF FAIRCHILD SEMICONDUCTOR CORPORATION. As used herein:

1. Life support devices or systems are devices or systems which, (a) are intended for surgical implant into the body, or (b) support or sustain life, and (c) whose failure to perform when properly used in accordance with instructions for use provided in labeling, can be reasonably expected to result in a significant injury of the user.
2. A critical component in any component of a life support device or system whose failure to perform can be reasonably expected to cause the failure of the life support device or system, or to affect its safety or effectiveness.