



HI117

PNP EPITAXIAL PLANAR TRANSISTOR

Description

The HI117 is designed for use in general purpose amplifier and low-speed switching applications.

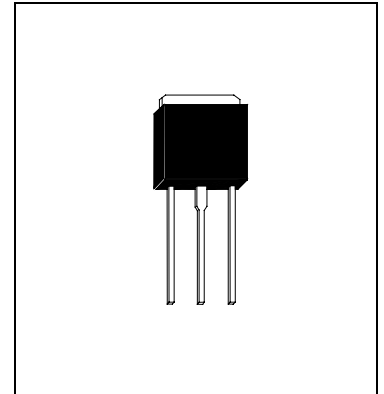

Absolute Maximum Ratings (Ta=25°C)

- Maximum Temperatures
 - Storage Temperature -55 ~ +150 °C
 - Junction Temperature +150 °C Maximum
- Maximum Power Dissipation
 - Total Power Dissipation (Tc=25°C) 25 W
- Maximum Voltages and Currents
 - BVCBO Collector to Base Voltage -100 V
 - BVCEO Collector to Emitter Voltage -100 V
 - BVEBO Emitter to Base Voltage -5 V
 - IC Collector Current (Continue) -4 A
 - IC Collector Current (Peak) -6 A

Characteristics (Ta=25°C)

Symbol	Min.	Typ.	Max.	Unit	Test Conditions
BVCBO	-100	-	-	V	IC=-1mA
BVCEO	-100	-	-	V	IC=-30mA
ICBO	-	-	-1	mA	VCB=-100V
ICEO	-	-	-2	mA	VCE=-50V
IEBO	-	-	-2	mA	VEB=-5V
*VCE(sat)	-	-	-2.5	V	IC=-2A, IB=-8mA
*VBE(on)	-	-	-2.8	V	IC=-2A, VCE=-4V
*hFE1	1	-	-	K	IC=-1A, VCE=-4V
*hFE2	500	-	-		IC=-2A, VCE=-4V
Cob	-	-	200	pF	VCB=-10V, f=0.1MHz

*Pulse Test : Pulse Width ≤380us, Duty Cycle≤2%

Darlington Schematic

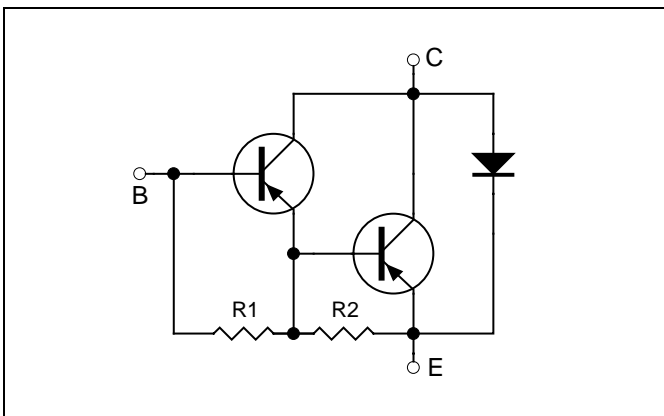



Characteristics Curve

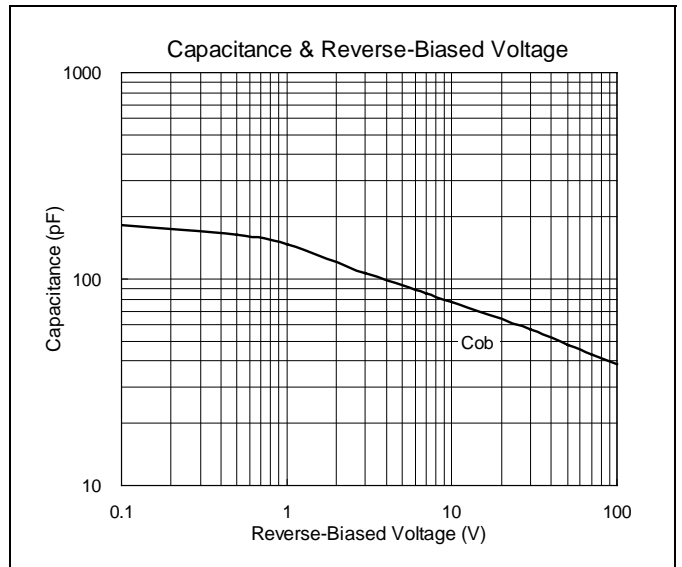
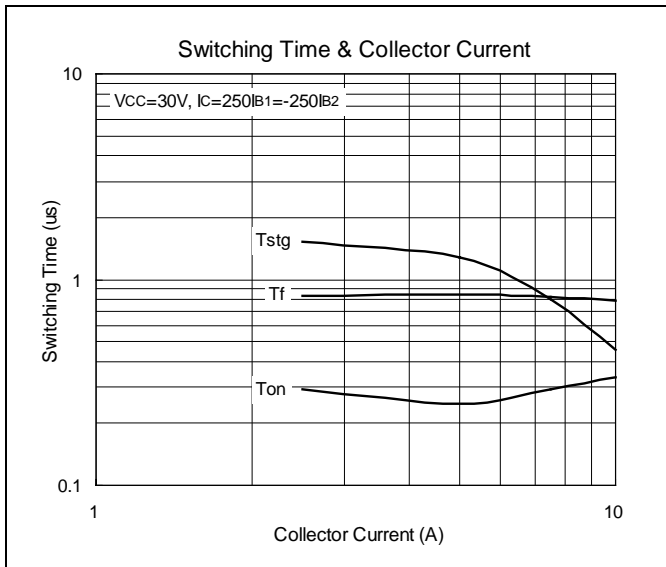
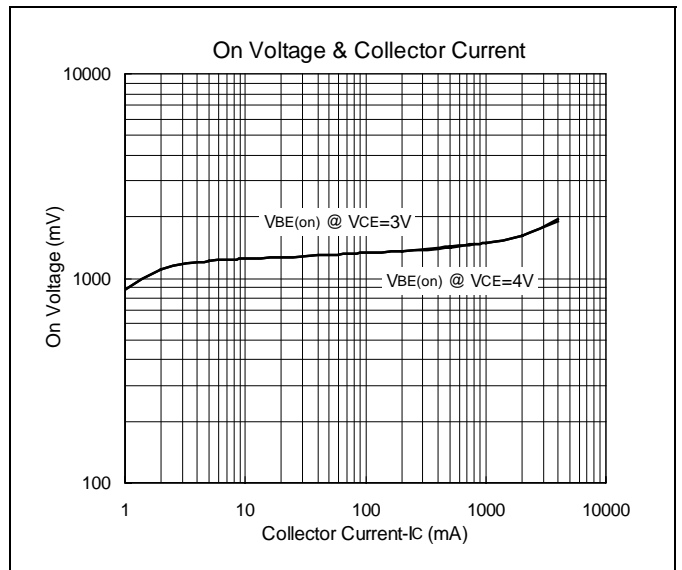
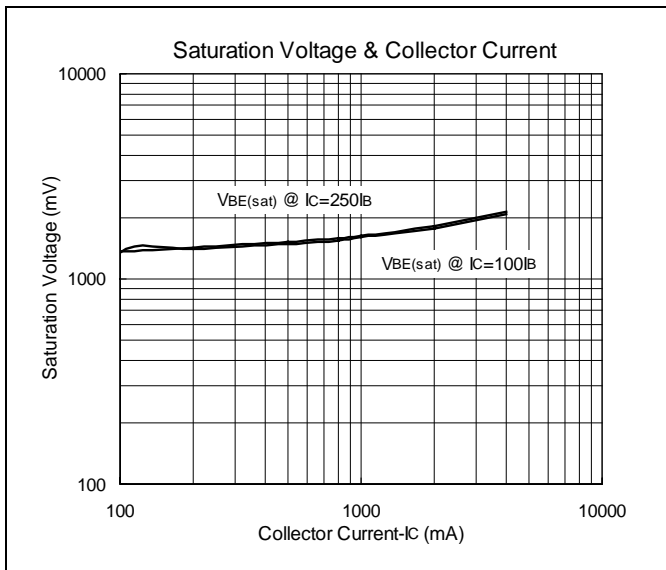
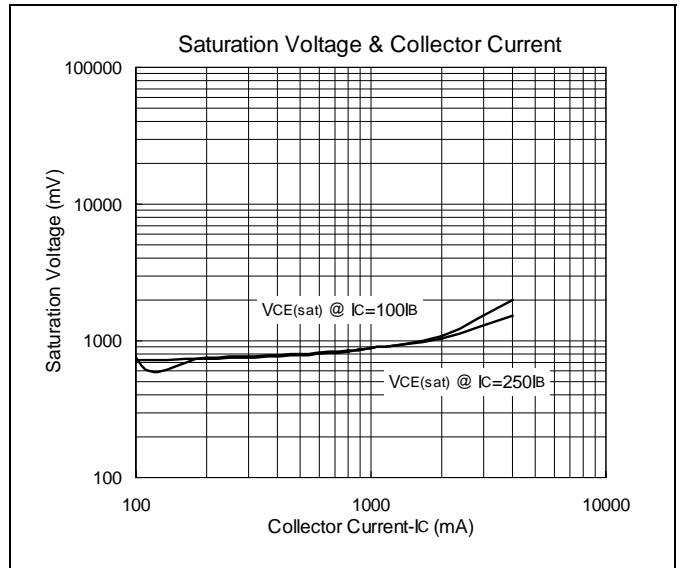
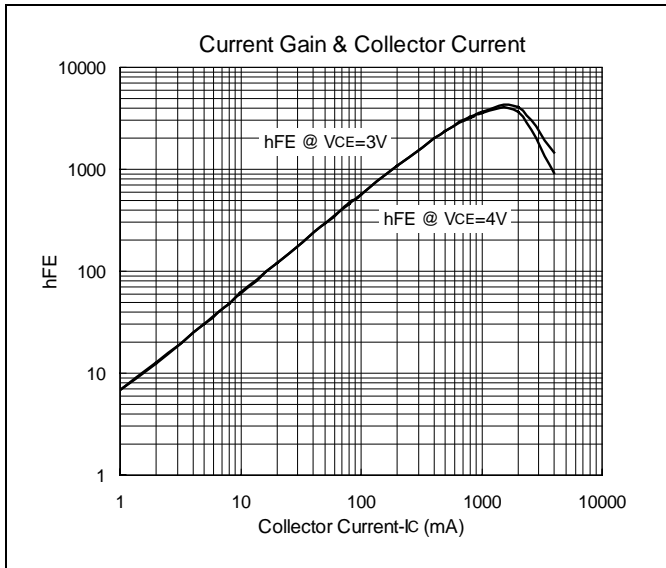

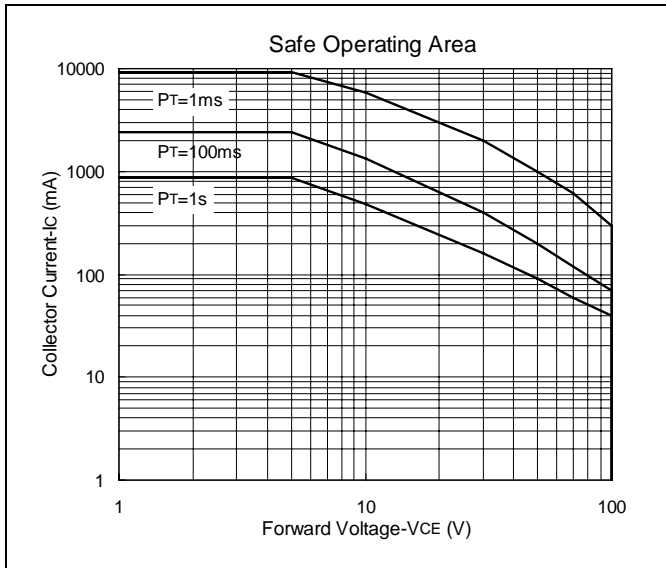



TO-251 Dimension

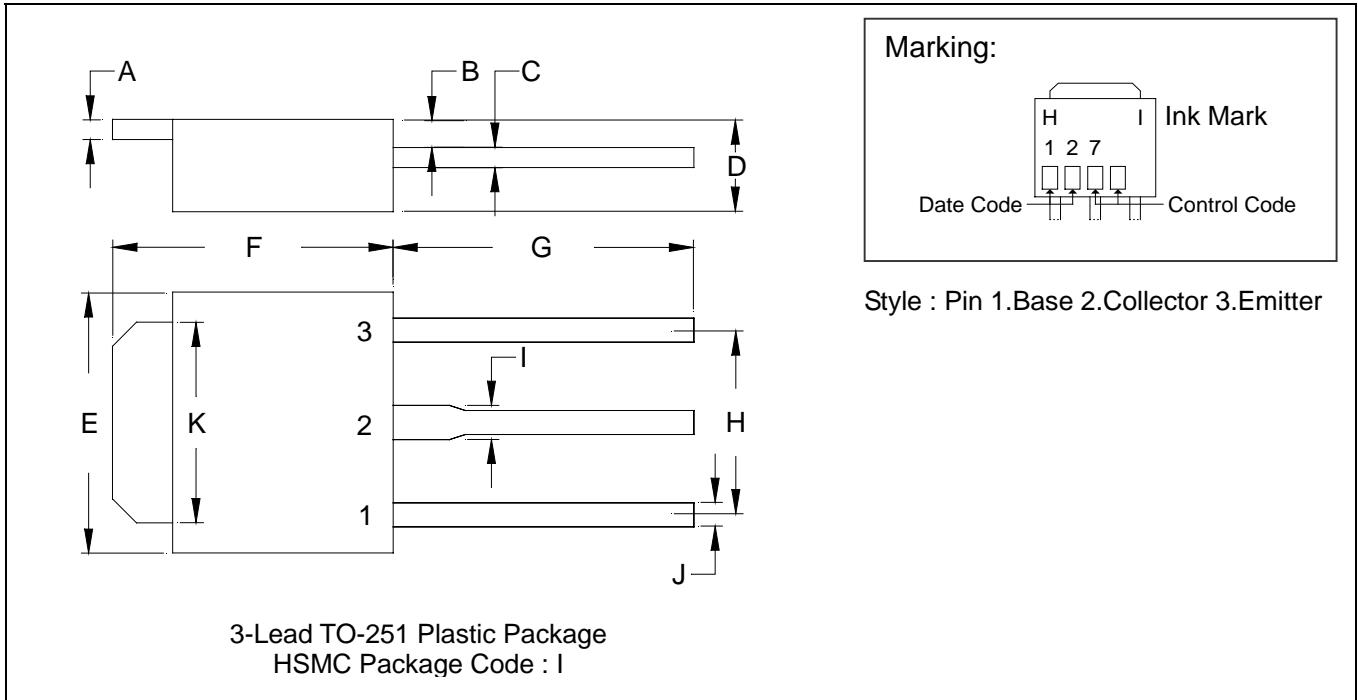

*:Typical

DIM	Inches		Millimeters		DIM	Inches		Millimeters	
	Min.	Max.	Min.	Max.		Min.	Max.	Min.	Max.
A	0.0177	0.0217	0.45	0.55	G	0.2559	-	6.50	-
B	0.0354	0.0591	0.90	1.50	H	-	*0.1811	-	*4.60
C	0.0177	0.0236	0.45	0.60	I	-	0.0354	-	0.90
D	0.0866	0.0945	2.20	2.40	J	-	0.0315	-	0.80
E	0.2520	0.2677	6.40	6.80	K	0.2047	0.2165	5.20	5.50
F	0.2677	0.2835	6.80	7.20					

- Notes :**
- 1.Dimension and tolerance based on our Spec. dated May. 24,1995.
 - 2.Controlling dimension : millimeters.
 - 3.Maximum lead thickness includes lead finish thickness, and minimum lead thickness is the minimum thickness of base material.
 - 4.If there is any question with packing specification or packing method, please contact your local HSMC sales office.

Material :

- Lead : 42 Alloy ; solder plating
- Mold Compound : Epoxy resin family, flammability solid burning class:UL94V-0

Important Notice:

- All rights are reserved. Reproduction in whole or in part is prohibited without the prior written approval of HSMC.
- HSMC reserves the right to make changes to its products without notice.
- **HSMC semiconductor products are not warranted to be suitable for use in Life-Support Applications, or systems.**
- HSMC assumes no liability for any consequence of customer product design, infringement of patents, or application assistance.

Head Office And Factory :

- **Head Office** (Hi-Sincerity Microelectronics Corp.) : 10F.,No. 61, Sec. 2, Chung-Shan N. Rd. Taipei Taiwan R.O.C.
Tel : 886-2-25212056 Fax : 886-2-25632712, 25368454
- **Factory 1** : No. 38, Kuang Fu S. Rd., Fu-Kou Hsin-Chu Industrial Park Hsin-Chu Taiwan. R.O.C
Tel : 886-3-5983621~5 Fax : 886-3-5982931